

RoHS Qxx15xx & Qxx16xHx Series



Description

15 Amp and 16 Amp bi-directional solid state switch series is designed for AC switching and phase control applications such as motor speed and temperature modulation controls, lighting controls, and static switching relays.

Standard type devices normally operate in Quadrants I & III triggered from AC line.

Alternistor type devices only operate in quadrants I, II, & III and are used in circuits requiring high dv/dt capability.

Features & Benefits

- RoHS Compliant
- Glass – passivated junctions
- Voltage capability up to 1000 V
- Surge capability up to 200 A
- Electrically isolated “L-Package” is UL recognized for 2500Vrms
- Solid-state switching eliminates arcing or contact bounce that create voltage transients
- No contacts to wear out from reaction of switching events
- Restricted (or limited) RFI generation, depending on activation point in sine wave
- Requires only a small gate activation pulse in each half-cycle

Agency Approval

| Agency | Agency File Number |
|--------|--------------------|
| | L Package : E71639 |

Main Features

| Symbol | Value | Unit |
|-------------------|-------------|------|
| $I_{T(RMS)}$ | 15 & 16 | A |
| V_{DRM}/V_{RRM} | 400 to 1000 | V |
| $I_{GT(Q1)}$ | 10 to 80 | mA |

Schematic Symbol



Applications

Excellent for AC switching and phase control applications such as heating, lighting, and motor speed controls.

Typical applications are AC solid-state switches, light dimmers, power tools, lawn care equipment, home/brown goods and white goods appliances.

Alternistor Triacs (no snubber required) are used in applications with extremely inductive loads requiring highest commutation performance.

Internally constructed isolated packages are offered for ease of heat sinking with highest isolation voltage.

Absolute Maximum Ratings — Standard Triac

| Symbol | Parameter | Value | Unit |
|--------------|--|--|-----------------------------|
| $I_{T(RMS)}$ | RMS on-state current (full sine wave) | Qxx15Ly $T_C = 80^\circ\text{C}$ | 15 A |
| | | Qxx15Ry Qxx15Ny $T_C = 90^\circ\text{C}$ | |
| I_{TSM} | Non repetitive surge peak on-state current (full cycle, T_J initial = 25°C) | f = 50 Hz t = 20 ms | 167 A |
| | | f = 60 Hz t = 16.7 ms | 200 A |
| I^2t | I^2t Value for fusing | $t_p = 8.3$ ms | 166 A^2s |
| di/dt | Critical rate of rise of on-state current | f = 120 Hz $T_J = 125^\circ\text{C}$ | 100 $\text{A}/\mu\text{s}$ |
| I_{GTM} | Peak gate trigger current | $t_p \leq 10 \mu\text{s}$ $I_{GT} \leq I_{GTM}$ $T_J = 125^\circ\text{C}$ | 2.0 A |
| $P_{G(AV)}$ | Average gate power dissipation | $T_J = 125^\circ\text{C}$ | 0.5 W |
| T_{stg} | Storage temperature range | | -40 to 150 $^\circ\text{C}$ |
| T_J | Operating junction temperature range | | -40 to 125 $^\circ\text{C}$ |

Note: xx = voltage, y = sensitivity

Absolute Maximum Ratings — Alternistor Triac (3 Quadrants)

| Symbol | Parameter | Value | Unit |
|--------------|--|--|-----------------------------|
| $I_{T(RMS)}$ | RMS on-state current (full sine wave) | Qxx16LHy $T_C = 80^\circ\text{C}$ | 16 A |
| | | Qxx16RHy Qxx16NHy $T_C = 90^\circ\text{C}$ | |
| I_{TSM} | Non repetitive surge peak on-state current (full cycle, T_J initial = 25°C) | f = 50 Hz t = 20 ms | 167 A |
| | | f = 60 Hz t = 16.7 ms | 200 A |
| I^2t | I^2t Value for fusing | $t_p = 8.3$ ms | 166 A^2s |
| di/dt | Critical rate of rise of on-state current | f = 120 Hz $T_J = 125^\circ\text{C}$ | 100 $\text{A}/\mu\text{s}$ |
| I_{GTM} | Peak gate trigger current | $t_p \leq 10 \mu\text{s}$; $I_{GT} \leq I_{GTM}$ $T_J = 125^\circ\text{C}$ | 2.0 A |
| $P_{G(AV)}$ | Average gate power dissipation | $T_J = 125^\circ\text{C}$ | 0.5 W |
| T_{stg} | Storage temperature range | | -40 to 150 $^\circ\text{C}$ |
| T_J | Operating junction temperature range | | -40 to 125 $^\circ\text{C}$ |

Note: xx = voltage, y = sensitivity

Electrical Characteristics ($T_J = 25^\circ\text{C}$, unless otherwise specified) — Standard Triac

| Symbol | Test Conditions | Quadrant | Value | Unit |
|----------|---|--------------|-------|----------------------------|
| I_{GT} | $V_D = 12\text{V}$ $R_L = 60 \Omega$ | I – II – III | MAX. | 50 mA |
| V_{GT} | | I – II – III | MAX. | 2.0 V |
| V_{GD} | $V_D = V_{DRM}$ $R_L = 3.3 \text{k}\Omega$ $T_J = 125^\circ\text{C}$ | I – II – III | MIN. | 0.2 V |
| I_H | $I_T = 100\text{mA}$ | | MAX. | 70 mA |
| dv/dt | $V_D = V_{DRM}$ Gate Open $T_J = 125^\circ\text{C}$ | 400V | MIN. | 275 $\text{V}/\mu\text{s}$ |
| | | 600V | | 225 $\text{V}/\mu\text{s}$ |
| | | 800V | | 200 $\text{V}/\mu\text{s}$ |
| | $V_D = V_{DRM}$ Gate Open $T_J = 100^\circ\text{C}$ | 1000V | | 200 $\text{V}/\mu\text{s}$ |
| (dv/dt)c | (di/dt)c = 8.1 A/ms $T_J = 125^\circ\text{C}$ | | MIN. | 4 $\text{V}/\mu\text{s}$ |
| t_{gt} | $I_G = 2 \times I_{GT}$ PW = 15 μs $I_T = 22.6 \text{A(pk)}$ | | TYP. | 4 μs |

Electrical Characteristics ($T_J = 25^\circ\text{C}$, unless otherwise specified) — Alternistor Triac (3 Quadrants)

| Symbol | Test Conditions | Quadrant | Qxx16xH2 | Qxx16xH3 | Qxx16xH4 | Qxx16xH6 | Unit | |
|----------|---|--------------|----------|----------|----------|----------|------|------------------|
| I_{GT} | $V_D = 12\text{V}$ $R_L = 60\ \Omega$ | I – II – III | MAX. | 10 | 20 | 35 | 80 | mA |
| V_{GT} | | I – II – III | MAX. | 1.3 | | | | V |
| V_{GD} | $V_D = V_{DRM}$ $R_L = 3.3\ \text{k}\Omega$ $T_J = 125^\circ\text{C}$ | I – II – III | MIN. | 0.2 | | | | V |
| I_H | $I_T = 100\text{mA}$ | | MAX. | 15 | 35 | 50 | 70 | mA |
| dv/dt | $V_D = V_{DRM}$ Gate Open $T_J = 125^\circ\text{C}$ | 400V | MIN. | 200 | 350 | 475 | 925 | V/ μs |
| | | 600V | | 150 | 250 | 400 | 850 | |
| | | 800V | | 100 | 200 | 350 | 475 | |
| | $V_D = V_{DRM}$ Gate Open $T_J = 100^\circ\text{C}$ | 1000V | | 100 | 200 | 300 | 350 | |
| (dv/dt)c | (di/dt)c = 8.6 A/ms $T_J = 125^\circ\text{C}$ | | MIN. | 2 | 20 | 25 | 30 | V/ μs |
| t_{gt} | $I_G = 2 \times I_{GT}$ $PW = 15\ \mu\text{s}$ $I_T = 22.6\ \text{A(pk)}$ | | TYP. | 3 | 3 | 3 | 5 | μs |

Static Characteristics

| Symbol | Test Conditions | Value | Unit | | |
|------------------------|--|------------------------------------|------|---|---------------|
| V_{TM} | 15A Device $I_T = 21.2\text{A}$ $t_p = 380\ \mu\text{s}$ | MAX | 1.60 | V | |
| | 16A Device $I_T = 22.6\text{A}$ $t_p = 380\ \mu\text{s}$ | | | | |
| I_{DRM} I_{RRM} | $V_D = V_{DRM} / V_{RRM}$ | $T_J = 25^\circ\text{C}$ 400-1000V | MAX | 5 | μA |
| | | $T_J = 125^\circ\text{C}$ 400-800V | | 2 | mA |
| | | $T_J = 100^\circ\text{C}$ 1000V | | 3 | |

Thermal Resistances

| Symbol | Parameter | Value | Unit | |
|-------------------|-----------------------|--|------|---------------------------|
| $R_{\theta(J-C)}$ | Junction to case (AC) | Qxx15Ry Qxx15Ny Qxx16RHy Qxx16NHy | 1.1 | $^\circ\text{C}/\text{W}$ |
| | | Qxx15Ly Qxx16LHy | 2.1 | |
| $R_{\theta(J-A)}$ | Junction to ambient | Qxx15Ry Qxx16RHy | 45 | $^\circ\text{C}/\text{W}$ |
| | | Qxx15Ly Qxx16LHy | 50 | |

Note: xx = voltage; y = sensitivity

Figure 1: Definition of Quadrants



Figure 2: Normalized DC Gate Trigger Current for All Quadrants vs. Junction Temperature

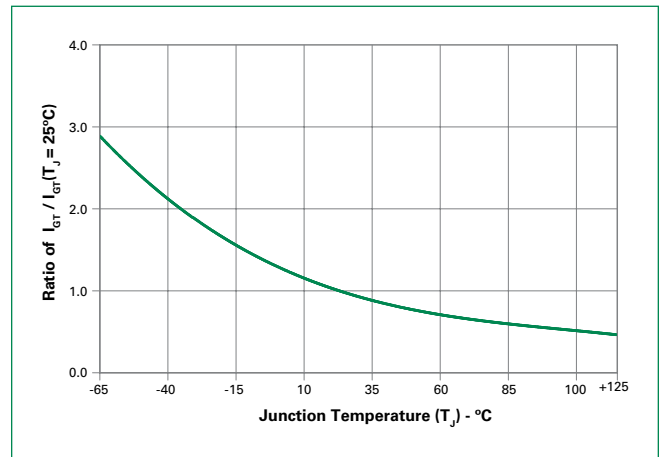

Figure 3: Normalized DC Holding Current vs. Junction Temperature



Figure 4: Normalized DC Gate Trigger Voltage for All Quadrants vs. Junction Temperature

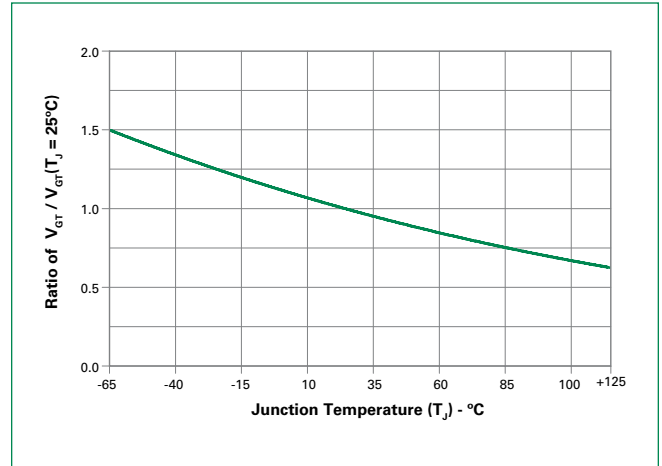

Figure 5: Power Dissipation (Typical) vs. RMS On-State Current



Figure 6: Maximum Allowable Case Temperature vs. On-State Current (15A devices)

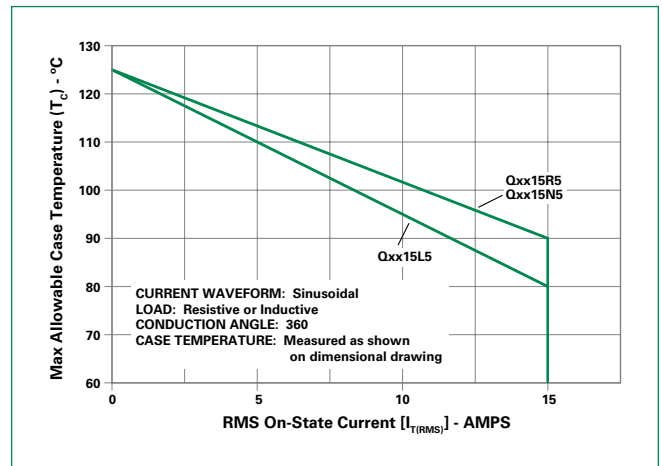

Figure 7: Maximum Allowable Case Temperature vs. On-State Current (16A devices)



Figure 8: Maximum Allowable Ambient Temperature vs. On-State Current

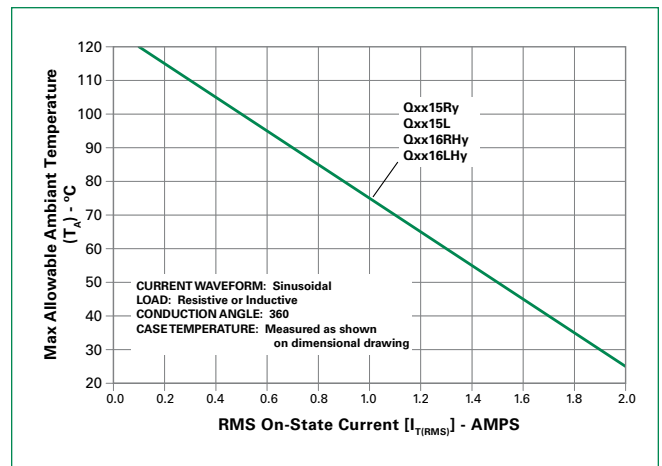
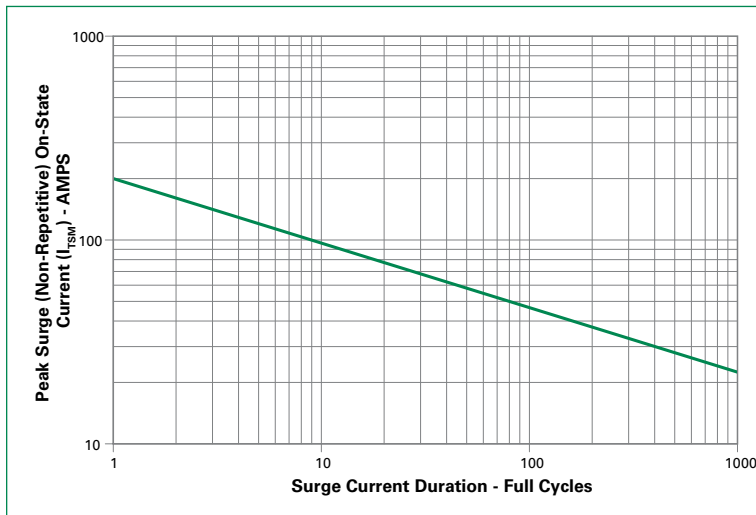

Figure 9: On-State Current vs. On-State Voltage (Typical)



Figure 10: Surge Peak On-State Current vs. Number of Cycles



Supply Frequency: 60Hz Sinusoidal
Load: Resistive
RMS On-State [$I_{T(RMS)}$]: Max Rated Value at Specific Case Temperature

Notes:

1. Gate control may be lost during and immediately following surge current interval.
2. Overload may not be repeated until junction temperature has returned to steady-state rated value.

Soldering Parameters

| | | |
|--|------------------------------------|------------------------|
| Reflow Condition | | Pb – Free assembly |
| Pre Heat | - Temperature Min ($T_{s(min)}$) | 150°C |
| | - Temperature Max ($T_{s(max)}$) | 200°C |
| | - Time (min to max) (t_s) | 60 – 180 secs |
| Average ramp up rate (Liquidus Temp) (T_L) to peak | | 5°C/second max |
| $T_{s(max)}$ to T_L - Ramp-up Rate | | 5°C/second max |
| Reflow | - Temperature (T_L) (Liquidus) | 217°C |
| | - Temperature (t_L) | 60 – 150 seconds |
| Peak Temperature (T_p) | | 260 ^{+0/5} °C |
| Time within 5°C of actual peak Temperature (t_p) | | 20 – 40 seconds |
| Ramp-down Rate | | 5°C/second max |
| Time 25°C to peak Temperature (T_p) | | 8 minutes Max. |
| Do not exceed | | 280°C |

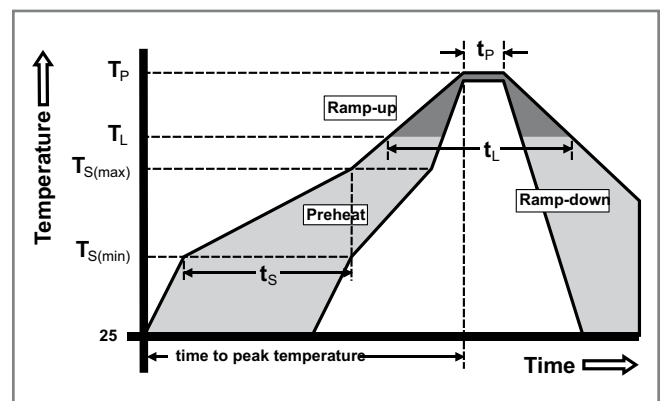

Physical Specifications

| | |
|--------------------------|---|
| Terminal Finish | 100% Matte Tin-plated |
| Body Material | UL recognized epoxy meeting flammability classification 94V-0 |
| Terminal Material | Copper Alloy |

Design Considerations

Careful selection of the correct device for the application's operating parameters and environment will go a long way toward extending the operating life of the Thyristor. Good design practice should limit the maximum continuous current through the main terminals to 75% of the device rating. Other ways to ensure long life for a power discrete semiconductor are proper heat sinking and selection of voltage ratings for worst case conditions. Overheating, overvoltage (including dv/dt), and surge currents are the main killers of semiconductors. Correct mounting, soldering, and forming of the leads also help protect against component damage.

Environmental Specifications

| Test | Specifications and Conditions |
|----------------------------------|---|
| AC Blocking | MIL-STD-750, M-1040, Cond A Applied Peak AC voltage @ 125°C for 1008 hours |
| Temperature Cycling | MIL-STD-750, M-1051, 100 cycles; -40°C to +150°C; 15-min dwell time |
| Temperature/Humidity | EIA / JEDEC, JESD22-A101 1008 hours; 320V - DC: 85°C; 85% rel humidity |
| High Temp Storage | MIL-STD-750, M-1031, 1008 hours; 150°C |
| Low-Temp Storage | 1008 hours; -40°C |
| Thermal Shock | MIL-STD-750, M-1056 10 cycles; 0°C to 100°C; 5-min dwell time at each temperature; 10 sec (max) transfer time between temperature |
| Autoclave | EIA / JEDEC, JESD22-A102 168 hours (121°C at 2 ATMs) and 100% R/H |
| Resistance to Solder Heat | MIL-STD-750 Method 2031 |
| Solderability | ANSI/J-STD-002, category 3, Test A |
| Lead Bend | MIL-STD-750, M-2036 Cond E |

Dimensions — TO-220AB (R-Package) — Non-Isolated Mounting Tab Common with Center Lead



| Dimension | Inches | | Millimeters | |
|-----------|--------|-------|-------------|-------|
| | Min | Max | Min | Max |
| A | 0.380 | 0.420 | 9.65 | 10.67 |
| B | 0.105 | 0.115 | 2.66 | 2.92 |
| C | 0.230 | 0.250 | 5.84 | 6.35 |
| D | 0.590 | 0.620 | 14.99 | 15.75 |
| E | 0.142 | 0.147 | 3.61 | 3.73 |
| F | 0.110 | 0.130 | 2.79 | 3.30 |
| G | 0.540 | 0.575 | 13.72 | 14.61 |
| H | 0.025 | 0.035 | 0.64 | 0.89 |
| J | 0.195 | 0.205 | 4.95 | 5.21 |
| K | 0.095 | 0.105 | 2.41 | 2.67 |
| L | 0.060 | 0.075 | 1.52 | 1.91 |
| M | 0.085 | 0.095 | 2.16 | 2.41 |
| N | 0.018 | 0.024 | 0.46 | 0.61 |
| O | 0.178 | 0.188 | 4.52 | 4.78 |
| P | 0.045 | 0.060 | 1.14 | 1.52 |
| R | 0.038 | 0.048 | 0.97 | 1.22 |

Dimensions — TO-220AB (L-Package) — Isolated Mounting Tab

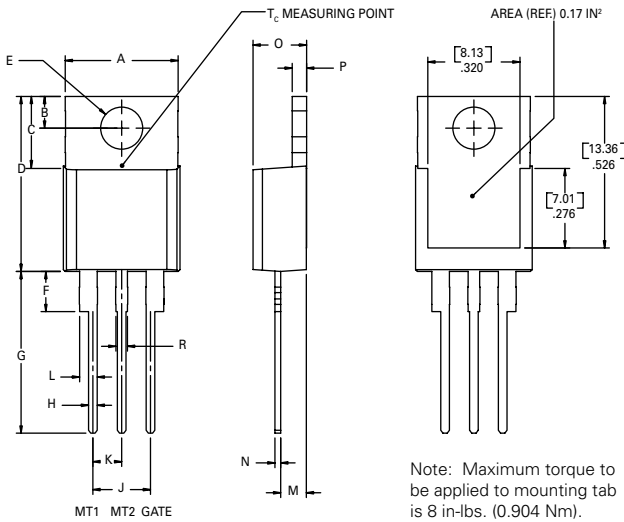

| Dimension | Inches | | Millimeters | |
|-----------|--------|-------|-------------|-------|
| | Min | Max | Min | Max |
| A | 0.380 | 0.420 | 9.65 | 10.67 |
| B | 0.105 | 0.115 | 2.67 | 2.92 |
| C | 0.230 | 0.250 | 5.84 | 6.35 |
| D | 0.590 | 0.620 | 14.99 | 15.75 |
| E | 0.142 | 0.147 | 3.61 | 3.73 |
| F | 0.110 | 0.130 | 2.79 | 3.30 |
| G | 0.540 | 0.575 | 13.72 | 14.60 |
| H | 0.025 | 0.035 | 0.64 | 0.89 |
| J | 0.195 | 0.205 | 4.95 | 5.21 |
| K | 0.095 | 0.105 | 2.41 | 2.67 |
| L | 0.060 | 0.075 | 1.52 | 1.91 |
| M | 0.085 | 0.095 | 2.16 | 2.41 |
| N | 0.018 | 0.024 | 0.46 | 0.61 |
| O | 0.178 | 0.188 | 4.52 | 4.78 |
| P | 0.045 | 0.060 | 1.14 | 1.52 |
| R | 0.038 | 0.048 | 0.97 | 1.22 |

Dimensions — TO-263AB (N-Package) — D²Pak Surface Mount



| Dimension | Inches | | Millimeters | |
|-----------|--------|-------|-------------|-------|
| | Min | Max | Min | Max |
| A | 0.360 | 0.370 | 9.14 | 9.40 |
| B | 0.380 | 0.420 | 9.65 | 10.67 |
| C | 0.178 | 0.188 | 4.52 | 4.78 |
| D | 0.025 | 0.035 | 0.64 | 0.89 |
| E | 0.045 | 0.060 | 1.14 | 1.52 |
| F | 0.060 | 0.075 | 1.52 | 1.91 |
| G | 0.095 | 0.105 | 2.41 | 2.67 |
| H | 0.092 | 0.102 | 2.34 | 2.59 |
| J | 0.018 | 0.024 | 0.46 | 0.61 |
| K | 0.090 | 0.110 | 2.29 | 2.79 |
| S | 0.590 | 0.625 | 14.99 | 15.88 |
| V | 0.035 | 0.045 | 0.89 | 1.14 |
| U | 0.002 | 0.010 | 0.05 | 0.25 |
| W | 0.040 | 0.070 | 1.02 | 1.78 |

Product Selector

| Part Number | Voltage | | | | Gate Sensitivity Quadrants | Type | Package |
|-------------|---------|------|------|-------|----------------------------|-------------------|----------------------------|
| | 400V | 600V | 800V | 1000V | I – II – III | | |
| Qxx15L5 | X | X | X | X | 50 mA | Standard Triac | TO-220L |
| Qxx15R5 | X | X | X | X | 50 mA | Standard Triac | TO-220R |
| Qxx15N5 | X | X | X | X | 50 mA | Standard Triac | TO-263 D ² -PAK |
| Qxx16LH2 | X | X | X | X | 10 mA | Alternistor Triac | TO-220L |
| Qxx16RH2 | X | X | X | X | 10 mA | Alternistor Triac | TO-220R |
| Qxx16NH2 | X | X | X | X | 10 mA | Alternistor Triac | TO-263 D ² -PAK |
| Qxx16LH3 | X | X | X | X | 20 mA | Alternistor Triac | TO-220L |
| Qxx16RH3 | X | X | X | X | 20 mA | Alternistor Triac | TO-220R |
| Qxx16NH3 | X | X | X | X | 20 mA | Alternistor Triac | TO-263 D ² -PAK |
| Qxx16LH4 | X | X | X | X | 35 mA | Alternistor Triac | TO-220L |
| Qxx16RH4 | X | X | X | X | 35 mA | Alternistor Triac | TO-220R |
| Qxx16NH4 | X | X | X | X | 35 mA | Alternistor Triac | TO-263 D ² -PAK |
| Qxx16LH6 | X | X | X | X | 80 mA | Alternistor Triac | TO-220L |
| Qxx16RH6 | X | X | X | X | 80 mA | Alternistor Triac | TO-220R |
| Qxx16NH6 | X | X | X | X | 80 mA | Alternistor Triac | TO-263 D ² -PAK |

Packing Options

| Part Number | Marking | Weight | Packing Mode | Base Quantity |
|--------------|------------|--------|------------------|-------------------|
| Qxx15L/Ry | Qxx15L/Ry | 2.2 g | Bulk | 500 |
| Qxx15L/RyTP | Qxx15L/Ry | 2.2 g | Tube Pack | 500 (50 per tube) |
| Qxx15NyTP | Qxx15Ny | 1.6 g | Tube | 500 (50 per tube) |
| Qxx15NyRP | Qxx15Ny | 1.6 g | Embossed Carrier | 500 |
| Qxx16L/RHy | Qxx16L/RHy | 2.2 g | Bulk | 500 |
| Qxx16L/RHyTP | Qxx16L/RHy | 2.2 g | Tube Pack | 500 (50 per tube) |
| Qxx16NHyTP | Qxx16NHy | 1.6 g | Tube | 500 (50 per tube) |
| Qxx16NHyRP | Qxx16NHy | 1.6 g | Embossed Carrier | 500 |

Note: xx = Voltage; y = Sensitivity

TO-263 Embossed Carrier Reel Pack (RP)

Meets all EIA-481-2 Standards



Part Numbering System



Part Marking System

TO-220 AB – (R Package)
TO-263 AB – (N Package)

