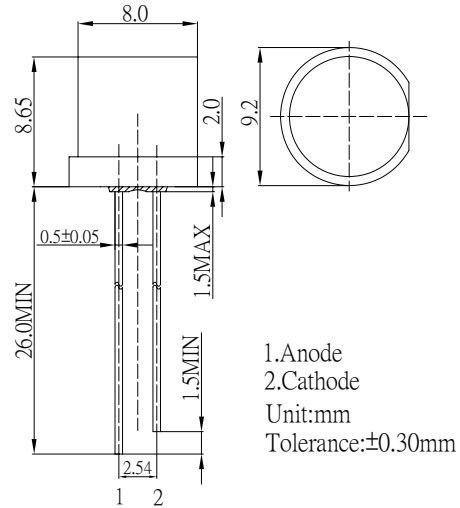

**■Features**

- High Luminous LEDs
- 8mm Flat Standard Directivity
- Superior Weather-resistance
- UV Resistant Epoxy
- Water Clear Type

**■Applications**

- Electronic Signs And Signals
- Small Area Illuminations
- Back Lighting
- Other Lighting

**■Outline Dimension**

**■Absolute Maximum Rating**

(Ta=25°C)

Item	Symbol	Value	Unit
DC Forward Current	I <sub>F</sub>	30	mA
Pulse Forward Current*	I <sub>FP</sub>	100	mA
Reverse Voltage	V <sub>R</sub>	5	V
Power Dissipation	P <sub>D</sub>	78	mW
Operating Temperature	T <sub>opr</sub>	-30 ~ +85	°C
Storage Temperature	T <sub>stg</sub>	-40 ~ +100	°C
Lead Soldering Temperature	T <sub>sol</sub>	260°C/5sec	-

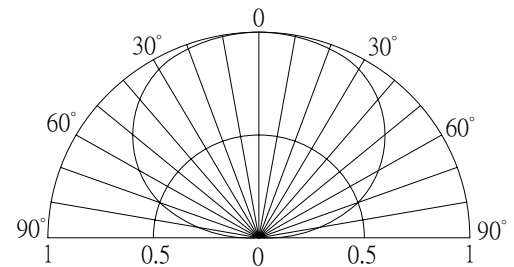
\*Pulse width Max.10ms Duty ratio max 1/10

**■Directivity**

**■Electrical -Optical Characteristics**

(Ta=25°C)

Item	Symbol	Condition	Min.	Typ.	Max.	Unit
DC Forward Voltage	V <sub>F</sub>	I <sub>F</sub> =20mA	1.8	2.1	2.6	V
DC Reverse Current	I <sub>R</sub>	V <sub>R</sub> =5V	-	-	10	μA
Domi. Wavelength*	λ <sub>D</sub>	I <sub>F</sub> =20mA	585	590	595	nm
Luminous Intensity*	I <sub>v</sub>	I <sub>F</sub> =20mA	500	700	-	mcd
50% Power Angle	2θ <sub>1/2</sub>	I <sub>F</sub> =20mA	-	140	-	deg

\*1 Tolerance of dominant wavelength is ±1nm

\*2 Tolerance of luminous intensity is ±15%