

LED DOT MATRIX
BL-M12X571XX
■ Features:

- 39.10mm (1.2") F 3.0 dot matrix LED display. BI-COLOR
- Low current operation.
- Excellent character appearance.
- Easy mounting on P.C. Boards or sockets.
- I.C. Compatible.
- ROHS Compliance.

Electrical-optical characteristics: (Ta=25) (Test Condition: IF=20mA)

Part No		Chip			VF Unit:V		Iv TYP.(mcd)
Row Cathode Column Anode	Row Anode Column Cathode	Emitted Color	Material	λ _p (nm)	Typ	Max	
BL-M12G571SG-XX	BL-M12H571SG-XX	Super Red	AlGaInP	660	2.10	2.50	100
		Green	GaP/GaP	570	2.20	2.50	95
BL-M12G571EG-XX	BL-M12H571EG-XX	Orange	GaAsP/GaP	635	2.10	2.50	90
		Green	GaP/GaP	570	2.20	2.50	95
BL-M12G571DUG-X X	BL-M12H571DUG-XX	Ultra Red	AlGaInP	660	2.10	2.50	110
		Ultra Green	AlGaInP	574	2.20	2.50	130
BL-M12G571UEUG- XX	BL-M12H571UEUG-X X	Ultra Orange	AlGaInP	630	2.10	2.50	100
		Ultra Green	AlGaInP	574	2.20	2.50	130

■ -XX: Surface / Lens color :

Number	0	1	2	3	4	5
Ref Surface Color	White	Black	Gray	Red	Green	
Epoxy Color	Water clear	White diffused	Red Diffused	Green Diffused	Yellow Diffused	

■ Absolute maximum ratings (Ta=25°C)

Parameter	S	G	E	D	UG	UE		U nit
Forward Current I _f	30	30	30	30	30	30		mA
Power Dissipation P _d	75	80	80	75	75	65		mW
Reverse Voltage V _R	5	5	5	5	5	5		V
Peak Forward Current I _{PF} (Duty 1/10 @ 1KHZ)	150	150	150	150	150	150		mA
Operation Temperature T _{OPR}	-40 to +80							
Storage Temperature T _{STG}	-40 to +85							
Lead Soldering Temperature T _{SOL}	Max.260±5 for 3 sec Max. (1.6mm from the base of the epoxy bulb)							

LED DOT MATRIX

BL-M12X571XX

Package configuration & Internal circuit diagram

BL-M12X571 Series

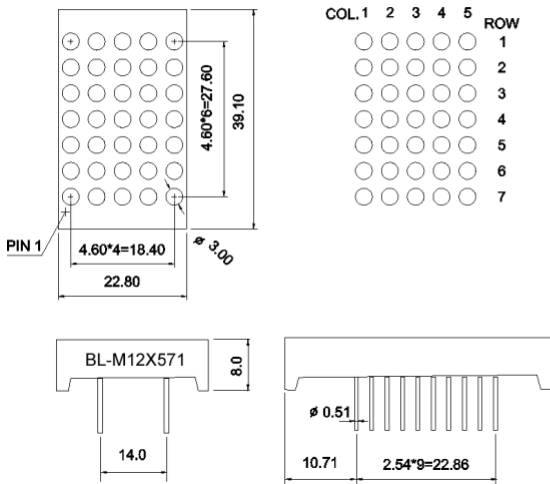

BL-M12G571XX

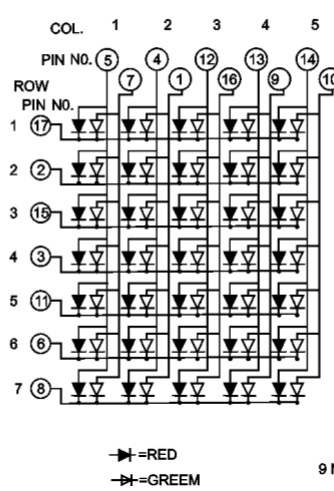

BL-M12H571XX

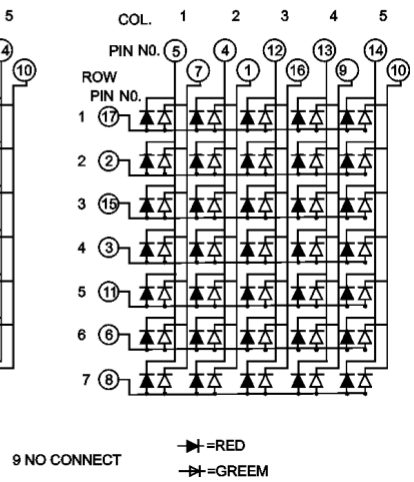

Notes:

1. All dimensions are in millimeters (inches)
2. Tolerance is $\pm 0.25(0.01)$ unless otherwise noted.
3. Specifications are subject to change without notice.

LED DOT MATRIX

BL-M12X571XX

Typical electrical-optical characteristics curves:

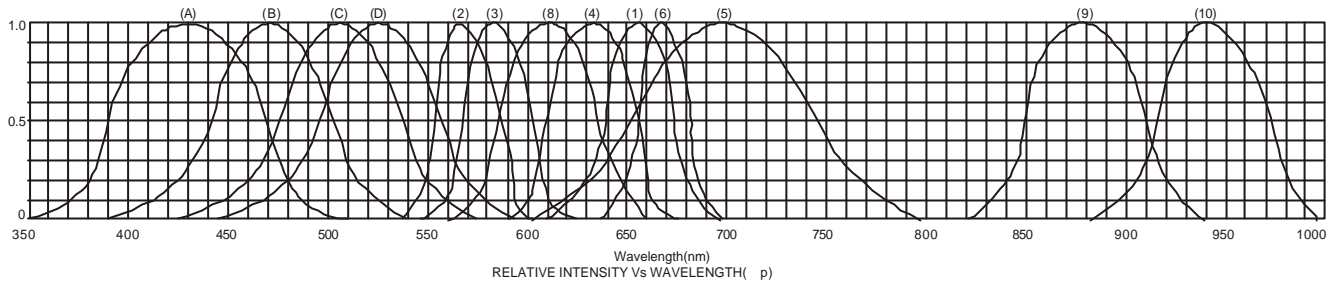

- | | |
|---|--------------------------------------|
| (1) - GaAsP/GaAs 655nm/Red | (9) - GaAlAs 880nm |
| (2) - GaP 570nm/Yellow Green | (10) - GaAs/GaAs & GaAlAs/GaAs 940nm |
| (3) - GaAsP/GaP 585nm/Yellow | (A) - GaN/SiC 430nm/Blue |
| (4) - GaAsP/GaP 635nm/Orange & Hi-Eff Red | (B) - InGaN/SiC 470nm/Blue |
| (5) - GaP 700nm/Bright Red | (C) - InGaN/SiC 505nm/Ultra Green |
| (6) - GaAlAs/GaAs 660nm/Super Red | (D) - InGaAl/SiC 525nm/Ultra Green |
| (8) - GaAsP/GaP 610nm/Super Red | |



FORWARD VOLTAGE (Vf)
FORWARD CURRENT VS.
FORWARD VOLTAGE



FORWARD CURRENT (mA)
RELATIVE LUMINOUS
INTENSITY VS. FORWARD
CURRENT

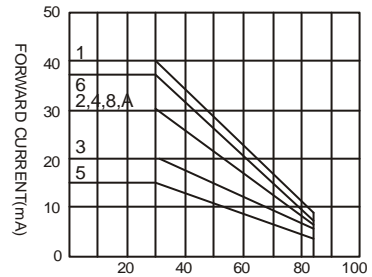

AMBIENT TEMPERATURE Ta()
FORWARD CURRENT VS. AMBIENT
TEMPERATURE

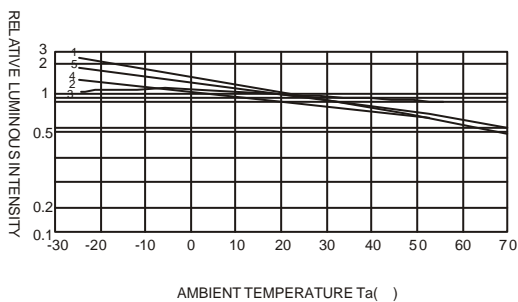

AMBIENT TEMPERATURE Ta()

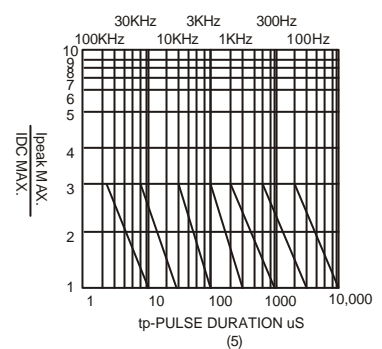

NOTE:25 free air temperature unless otherwise specified