

PLEASE CHECK WWW.MOLEX.COM FOR LATEST PART INFORMATION

Part Number: [0351500290](#)
Status: **Active**
Overview: [versablade](#)
Description: 1.78mm (.070") Tab Wire-to-Wire TPA™, 6.20mm (.244") Pitch, 2 Circuits, White

Documents:

3D Model	Product Specification PS-35524-001 (PDF)
Drawing (PDF)	RoHS Certificate of Compliance (PDF)
Product Specification PS-35150-001 (PDF)	

Agency Certification

CSA	LR19980
TUV	R72090206
UL	E29179

General

Product Family	Accessories
Series	35150
Comments	35150 VersaBlade™ Hybrid Receptacle Housing, 35151
Component Type	Retainer
Overview	versablade
Product Name	VersaBlade™

Physical

Circuits (Loaded)	2
Color - Resin	Natural
Flammability	94V-0
Lock to Mating Part	Yes
Material - Resin	Nylon
Number of Rows	1
Packaging Type	Bag
Temperature Range - Operating	-40°C to +120°C

Material Info

Reference - Drawing Numbers

Product Specification	PS-35150-001, PS-35524-001
Sales Drawing	SD-35150-029*

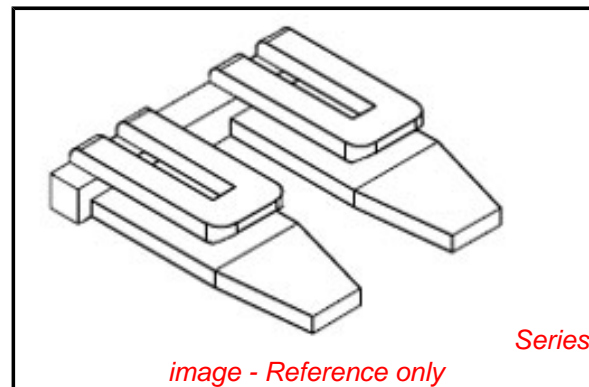

EU RoHS

**ELV and RoHS
Compliant**
**REACH SVHC
Contains SVHC: No**
**Halogen-Free
Status**

China RoHS



**Need more information on product
environmental compliance?**

Email productcompliance@molex.com
 For a multiple part number RoHS Certificate of Compliance, [click here](#)

Please visit the [Contact Us](#) section for any non-product compliance questions.

Search Parts in this Series

[35150Series](#)

Use With

[35150](#) VersaBlade™ Hybrid Receptacle Housing, [35151](#)

ENG. NO.
SD_35150-029*

EDP NO.

SIMILAR ITEM

PROJECT NO.
.070 W/W CONN'

8 7 6 5 4 3 2 1

NOTES

- MATERIAL : NYLON 66 (UL94V-2)
- COLOR : 35150-0290 (NATURAL)
35150-0292 (RED)
35150-0293 (YELLOW)
35150-0294 (BLUE)
- MATCHED HOUSING : 35150-020*/021*
35151-021*
35150-040*/041*
35151-041*

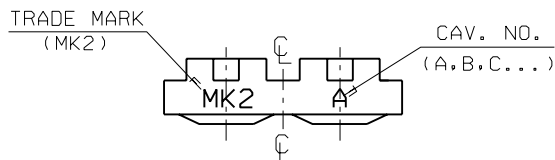
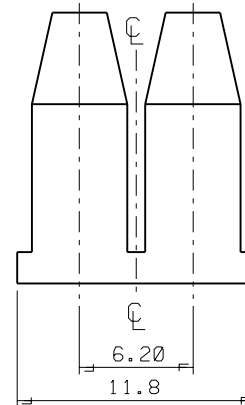
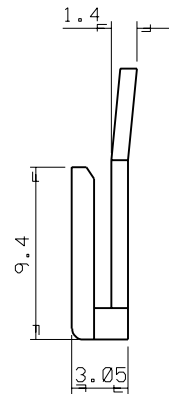
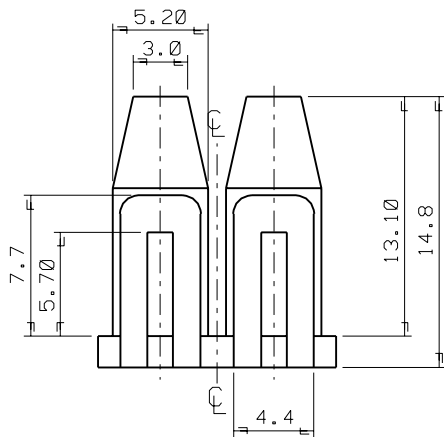
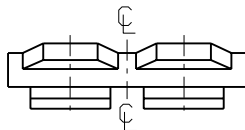
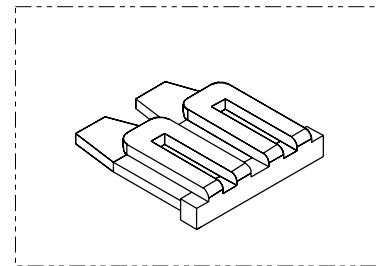

				MATERIAL SEE NOTES		molex MOLEX-KOREA CO.,LTD.	
				GENERAL TOLERANCE		DRAWN BY J.S.KANG	
				DIMENSION : ±0.3		CHK'D BY	
				ANGLE : ±1°		APP'D BY	
				DIMENSION CLASSIFICATION		SCALE 4/1	
				▽: CRITICAL ▼: MAJOR		TITLE:	
				(): REFERENCE		6.2 PITCH W/W CONN'	
A NEW RELEASED		95 3.10		ASS'Y PART		SHEET	
LTR REVISION RECORD		ECN DATE		DESCRIPTION ENG. NO.		1 OF 1	
REVISE ONLY ON CAD SYSTEM				---		REV A	
				---		ENG. NO. SD 35150-029*	