

Features

- Integer Unit Based on SPARC V7 High-performance RISC Architecture
- Optimized Integrated 32/64-bit Floating-point Unit
- On-chip Peripherals
 - EDAC and Parity Generator and Checker
 - Memory Interface
 - Chip Select Generator
 - Waitstate Generation
 - Memory Protection
 - DMA Arbiter
 - Timers
 - General Purpose Timer (GPT)
 - Real-time Clock Timer (RTCT)
 - Watchdog Timer (WDT)
 - Interrupt Controller With 5 External Inputs
 - General Purpose Interface (GPI)
 - Dual UART
- Speed Optimized Code RAM Interface
- 8- or 40-bit boot-PROM (Flash) Interface
- IEEE 1149.1 Test Access Port (TAP) for Debugging and Test Purposes
- Fully Static Design
- Performance: 12 MIPs/3 MFlops (Double Precision) at SYSCLK = 15 MHz
- Core Consumption: 0.3W Typ. at 12 MIPs
- Operating Range: 3.15V to 3.45V -55°C to +125°C
- Tested up to a Total Dose of 300 Krds (si) according to MIL STD 883 Method 1019
- No Single Event Latch-up Below an LET Threshold of 80 MeV/mg/cm²
- Single Event Upsets Error Rate Better than:
 - 2 E-7 Error/Component/Day in GEO Orbit
 - 5 E-5 Error/Component/Day in LEO Orbit (53°, 1000 km)
- Quality Grades: ESCC, and QMLQ or V with 5962-03246
- Package: 256 MQFPF; Bare Die

Description

The TSC695FL (ERC32 Single-Chip) is a highly integrated, high-performance 32-bit RISC embedded processor implementing the SPARC architecture V7 specification. It has been developed with the support of the ESA (European Space Agency), and offers a full development environment for embedded space applications.

The processor is manufactured using the Atmel 0.5 µm radiation tolerant (≥ 300 KRADs (Si)) CMOS enhanced process (RTP). It can operate at a low voltage for optimized power consumption (see datasheet TSC695FL). It has been specially designed for space, as it has on-chip concurrent transient and permanent error detection.

The TSC695FL includes an on-chip Integer Unit (IU), a Floating Point Unit (FPU), a Memory Controller and a DMA arbiter. For real-time applications, the TSC695FL offers a high security watchdog, two timers, an interrupt controller, parallel and serial interfaces. Fault tolerance is supported using parity on internal/external buses and an EDAC on the external data bus. The design is highly testable with the support of an On-Chip Debugger (OCD), and a boundary scan through JTAG interface.

The TSC695FL is a selection of the TSC5695F performed for a narrow 3.3V biasing voltage range ($\pm 0.15V$), as such, this specification can be only met by the products sold as TSC695FL. Where computing power is not the key factor, it allows for a dramatic power consumption reduction (70%).



Low-Voltage Rad-Hard 32-bit SPARC Embedded Processor

TSC695FL



Block Diagram

Figure 1. TSC695FL Block Diagram

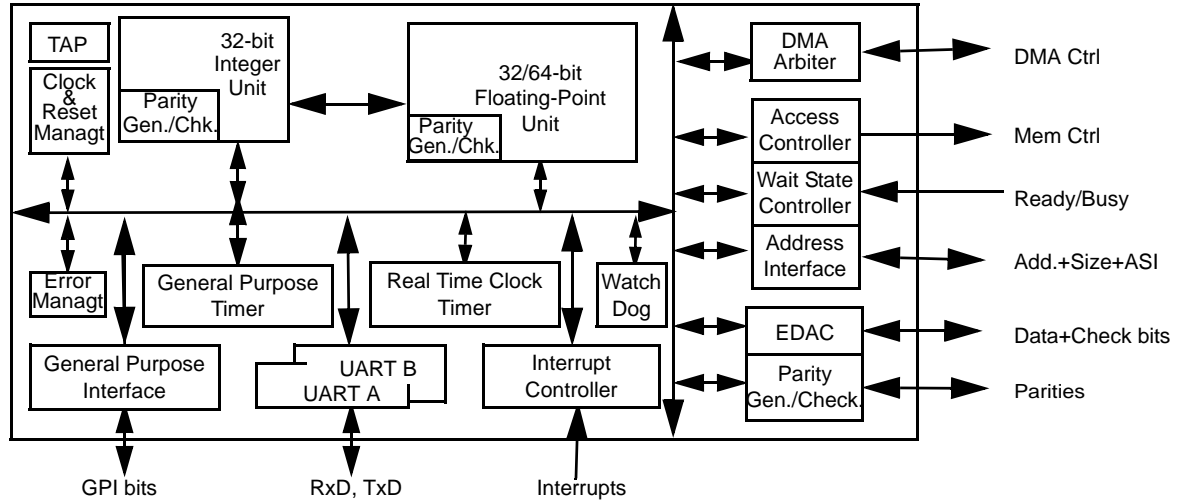

Pin Descriptions

For pin assignment, refer to package section.

Signal	Type	Active	Description	
RA[31:0]	I/O,		32-bit registered address bus	Output buffer: 400 pF
RAPAR	I/O	High	Registered address bus parity	-
RASI[3:0]	I/O		4-bit registered address space identifier	-
RSIZE[1:0]	I/O		2-bit registered bus transaction size	-
RASPAR	I/O	High	Registered ASI and SIZE parity	-
CPAR	I/O	High	Control bus parity	-
D[31:0]	I/O		32-bit data bus	-
CB[6:0]	I/O		7-bit check-bit bus	-
DPAR	I/O	High	Data bus parity	-
RLDSTO	I/O	High	Registered atomic load-store	-
$\overline{\text{ALE}}$	O	Low	Address latch enable	-
DXFER	I/O	High	Data transfer	-
LOCK	I/O	High	Bus lock	-
RD	I/O	High	Read access	-
$\overline{\text{WE}}$	I/O	Low	Write enable	-
WRT	I/O	High	Advanced write	-
$\overline{\text{MHOLD}}$	O	Low	Memory bus hold	MHOLD+FHOLD +BHOLD+FCCV
$\overline{\text{MDS}}$	O	Low	Memory data strobe	-
$\overline{\text{MEXC}}$	O	Low	Memory exception	-
PROM8	I	Low	Select 8-bit wide PROM	-
BA[1:0]	O		Latched address used for 8-bit wide boot PROM	-
$\overline{\text{ROMCS}}$	O	Low	PROM chip select	-
$\overline{\text{ROMWRT}}$	I	Low	ROM write enable	-
$\overline{\text{MEMCS}}[9:0]$	O	Low	Memory chip select	Output buffer: 400 pF
$\overline{\text{MEMWR}}$	O	Low	Memory write strobe	Output buffer: 400 pF

Signal	Type	Active	Description	
\overline{OE}	O	Low	Memory output enable	Output buffer: 400 pF
\overline{BUFFEN}	O	Low	Data buffer enable	-
\overline{DDIR}	O	High	Data buffer direction	-
\overline{DDIR}	O	Low	Data buffer direction	-
$\overline{IOSEL[3:0]}$	O	Low	I/O chip select	-
\overline{IOWR}	O	Low	I/O and exchange memory write strobe	-
\overline{EXMCS}	O	Low	Exchange memory chip select	-
\overline{BUSRDY}	I	Low	Bus ready	-
\overline{BUSERR}	I	Low	Bus error	-
\overline{DMAREQ}	I	Low	DMA request	-
\overline{DMAGNT}	O	Low	DMA grant	-
\overline{DMAAS}	I	High	DMA address strobe	-
\overline{DRDY}	O	Low	Data ready during DMA access	-
\overline{IUERR}	O	Low	IU error	-
$\overline{CPUHALT}$	O	Low	Processor (IU & FPU) halt and freeze	-
\overline{SYSERR}	O	Low	System error	-
$\overline{SYSHALT}$	I	Low	System halt	-
\overline{SYSAV}	O	High	System availability	-
\overline{NOPAR}	I	Low	No parity	-
\overline{INULL}	O	High	Integer unit nullify cycle	-
\overline{INST}	O	High	Instruction fetch	Used to check the execute stage of IU instruction pipeline
\overline{FLUSH}	O	High	FPU instruction flush	
\overline{DIA}	O	High	Delay instruction annulled	
\overline{RTC}	O	High	Real Time Clock Counter output	-
RxA/RxB	I		Receive data UART 'A' and 'B'	Input trigger
TxA/TxB	O		Transmit data UART 'A' and 'B'	-
$\overline{GPI[7:0]}$	I/O		GPI input/output	Input trigger
\overline{GPIINT}	O	High	GPI interrupt	-
$\overline{EXTINT[4:0]}$	I		External interrupt	Input trigger
$\overline{EXTINTACK}$	O	High	External interrupt acknowledge	-
\overline{IWDE}	I	High	Internal watch dog enable	-
\overline{EWDINT}	I	High	External watch dog input interrupt	Input trigger
\overline{WDCLK}	I		Watch dog clock	-
$\overline{CLK2}$	I		Double frequency clock	-
\overline{SYSCLK}	O		System clock	-
\overline{RESET}	O	Low	Output reset	-
$\overline{SYSRESET}$	I	Low	System input reset	Input trigger
$\overline{TMODE[1:0]}$	I		Factory test mode	Functional mode=00
\overline{DEBUG}	I	High	Software debug mode	-
\overline{TCK}	I		Test (JTAG) clock	-
\overline{TRST}	I	Low	Test (JTAG) reset	pull-up \approx 37 k Ω
\overline{TMS}	I		Test (JTAG) mode select	pull-up \approx 37 k Ω
\overline{TDI}	I		Test (JTAG) data input	pull-up \approx 37 k Ω
\overline{TDO}	O		Test (JTAG) data output	-
$\overline{VCCI/VSSI}$			Main internal power	-
$\overline{VCCO/VSSO}$			Output driver power	-

Note: If not specified, the output buffer type is 150 pF, the input buffer type is TTL.

System Architecture

The TSC695FL is to be used as an embedded processor requiring only memory and application specific peripherals to be added to form a complete on-board computer. All other system support functions are provided by the core.

Figure 2. System Architecture Based on TSC695FL

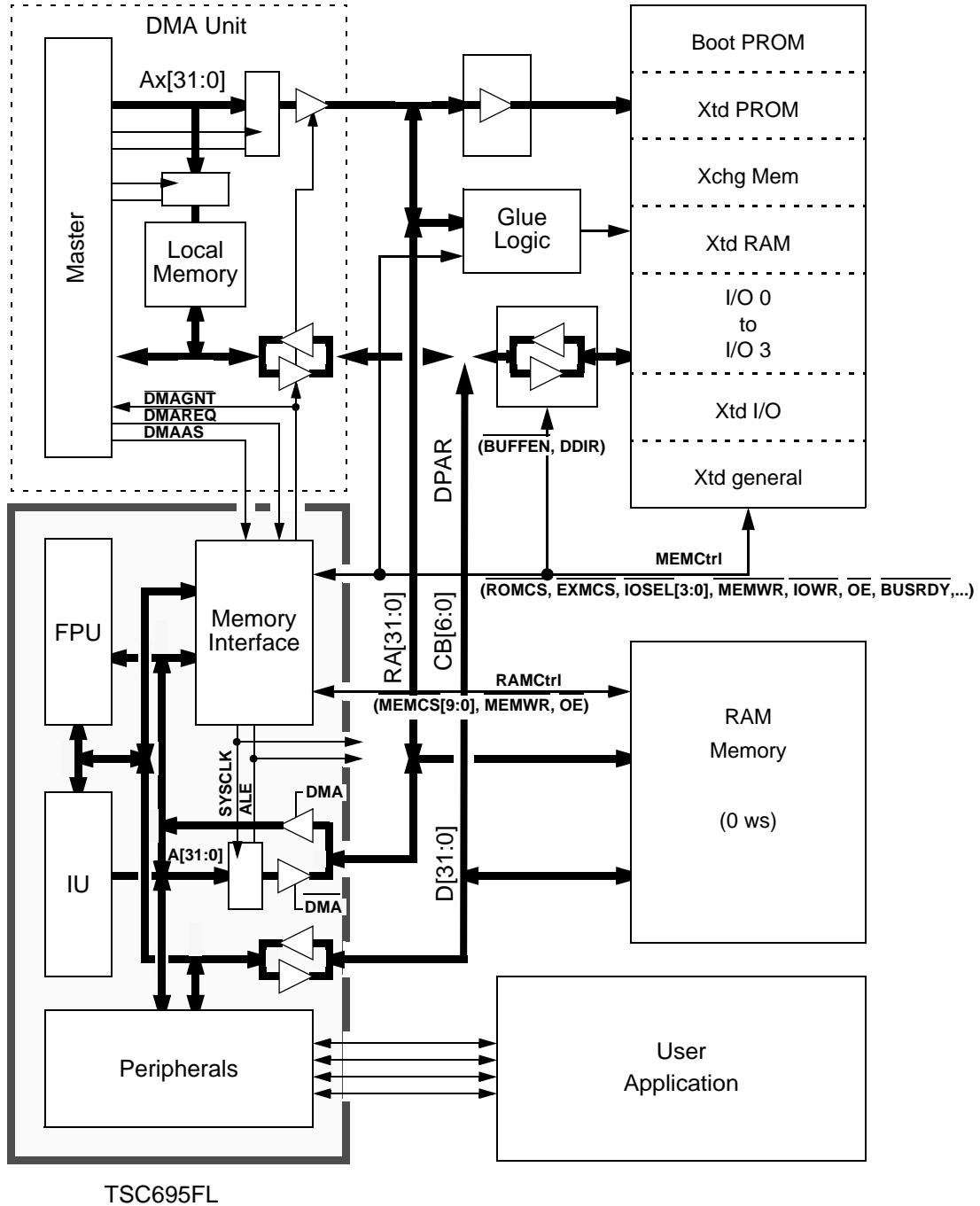

Product Description

Integer Unit

The IU is designed for highly dependable space and military applications, and includes support for error detection. The RISC architecture makes the creation of a processor that can execute instructions at a rate approaching one instruction per processor clock possible.

To achieve that rate of execution, the IU employs a four-stage instruction pipeline that permits parallel execution of multiple instructions.

- Fetch - The processor outputs the instruction address to fetch the instruction.
- Decode - The instruction is placed in the instruction register and is decoded. The processor reads the operands from the register file and computes the next instruction address.
- Execute - The processor executes the instruction and saves the results in temporary registers. Pending traps are prioritized and internal traps are taken during this stage.
- Write - If no trap is taken, the processor writes the result to the destination register.

All four stages operate in parallel, working on up to four different instructions at a time. A basic 'single-cycle' instruction enters the pipeline and completes in four cycles.

By the time it reaches the write stage, three more instructions have entered and are moving through the pipeline behind it. So, after the first four cycles, a single-cycle instruction exits the pipeline and a single-cycle instruction enters the pipeline on every cycle. Of course, a 'single-cycle' instruction actually takes four cycles to complete, but they are called single cycle because with this type of instruction the processor can complete one instruction per cycle after the initial four-cycle delay.

Floating-point Unit

The FPU is designed to provide execution of single and double-precision floating-point instructions concurrently with execution of integer instructions by the IU. The FPU is compliant to the ANSI/IEEE-754 (1985) floating-point standard.

The FPU is designed for highly dependable space and military applications, and includes support for concurrent error detection and testability.

The FPU uses a four stage instruction pipeline consisting of fetch, decode, execute and write stages (F, D, E and W). The fetch unit captures instructions and their addresses from the data and address busses. The decode unit contains logic to decode the floating-point instruction opcodes. The execution unit handles all instruction execution. The execution unit includes a floating-point queue (FP queue), which contains stored floating-point operate (FPop) instructions under execution and their addresses. The execution unit controls the load unit, the store unit, and the datapath unit. The FPU depends upon the IU to access all addresses and control signals for memory access. Floating-point loads and stores are executed in conjunction with the IU, which provides addresses and control signals while the FPU supplies or stores the data. Instruction fetch for integer and floating-point instructions is provided by the IU.

The FPU provides three types of registers: f registers, FSR, and the FP queue. The FSR is a 32-bit status and control register. It keeps track of rounding modes, floating-point trap types, queue status, condition codes, and various IEEE exception information. The floating-point queue contains the floating-point instruction currently under execution, along with its corresponding address.



Instruction Set

TSC695FL instructions fall into six functional categories: load/store, arithmetic/logical/shift, control transfer, read/write control register, floating-point, and miscellaneous. Please refer to SPARC V7 Instruction-set Manual.

Note: The execution of IFLUSH will cause an illegal instruction trap.

On-chip Peripherals

Memory Interface

The TSC695FL is designed to allow easy interfacing to internal/external memory resources.

Table 1. Memory Mapping

Memory Contents	Start Address	Size (bytes)	Data Size and Parity Options	
Boot PROM	0x00000000	128K → 16M	8-bit mode	No parity/-No EDAC/-Only byte write
			40-bit mode	Parity + EDAC mandatory/-Only word write
Extended PROM	0x01000000	Max: 15M	8-bit mode	No parity/-No EDAC/-Only byte write
			40-bit mode	Parity + EDAC mandatory/-Only word write
Exchange Memory	0x01F00000	4K → 512K	Parity + EDAC option/-Only word write	
System Registers	0x01F80000	512K (124 used)	Parity/-Only word read/write access	
RAM (8 blocks)	0x02000000	8*32K → 8*4M	Parity + EDAC option/-All data sizes allowed	
Extended RAM	0x04000000	Max: 192M		
I/O Area 0	0x10000000	0 → 16M		
I/O Area 1	0x11000000	0 → 16M		
I/O Area 2	0x12000000	0 → 16M		
I/O Area 3	0x13000000	0 → 16M		
Extended I/O Area	0x14000000	Max: 1728M		
Extended General	0x80000000	Max: 2G	No parity/-All data sizes allowed	

System Registers

The system registers are only writeable by IU in the supervisor mode or by DMA during halt mode.

Table 2. System Registers Address Map

System Register Name		Address
System Control Register	SYSTR	0x 01F8 0000
Software Reset	SWRST	0x 01F8 0004
Power Down	PDOWN	0x 01F8 0008
System Fault Status Register	SYSFSR	0x 01F8 00A0
Failing Address Register	FAILAR	0x 01F8 00A4
Error & Reset Status Register	ERRRSR	0x 01F8 00B0
Test Control Register	TESCTR	0x 01F8 00D0

Table 2. System Registers Address Map (Continued)

System Register Name		Address
Memory Configuration Register	MCNFR	0x 01F8 0010
I/O Configuration Register	IOCNFR	0x 01F8 0014
Waitstate Configuration Register	WSCNFR	0x 01F8 0018
Access Protection Segment 1 Base Register	APS1BR	0x 01F8 0020
Access Protection Segment 1 End Register	APS1ER	0x 01F8 0024
Access Protection Segment 2 Base Register	APS2BR	0x 01F8 0028
Access Protection Segment 2 End Register	APS2ER	0x 01F8 002C
Interrupt Shape Register	INTSHR	0x 01F8 0044
Interrupt Pending Register	INTPDR	0x 01F8 0048
Interrupt Mask Register	INTMKR	0x 01F8 004C
Interrupt Clear Register	INTCLR	0x 01F8 0050
Interrupt Force Register	INTFCR	0x 01F8 0054
Watchdog Timer Register	WDOGTR	0x 01F8 0060
Watchdog Timer Trap Door Set	WDOGST	0x 01F8 0064
Real Time Clock Timer <Counter> Register	RTCCR	0x 01F8 0080
Real Time Clock Timer <Scaler> Register	RTCSR	0x 01F8 0084
General Purpose Timer <Counter> Register	GPTCR	0x 01F8 0088
General Purpose Timer <Scaler> Register	GPTSR	0x 01F8 008C
Timers Control Register	TIMCTR	0x 01F8 0098
General Purpose Interface Configuration Register	GPICNFR	0x 01F8 00A8
General Purpose Interface Data Register	GPIDATR	0x 01F8 00AC
UART 'A' Rx & Tx Register	UARTAR	0x 01F8 00E0
UART 'B' Rx & Tx Register	UARTBR	0x 01F8 00E4
UART Status Register	UARTSR	0x 01F8 00E8

Wait-state and Time-out Generator

It is possible to control the wait state generation by programming a Waitstate Configuration Register. The maximum programmable number of wait-states is applied by default at reset.

It is possible to program the number of wait states for the following combinations:

- RAM read and write
- PROM read and write (i.e. EEPROM or Flash write)
- Exchange Memory read/write
- Four individual I/O peripherals read/write

A bus time-out function of 256 system clock cycles is provided for the bus ready controlled memory areas, i.e. the Extended PROM, Exchange Memory, Extended RAM, Extended I/O and the Extended General areas.

EDAC The TSC695FL includes a 32-bit EDAC (Error Detection And Correction). Seven bits (CB[6:0]) are used as check bits over the data bus. The Data Bus Parity signal (DPA) is used to check and generate the odd parity over the 32-bit data bus. This means that altogether 40 bits are used when the EDAC is enabled.

The TSC695FL EDAC uses a 7-bit Hamming code which detects any double bit error on the 40-bit bus as a non-correctable error. In addition, the EDAC detects all bits stuck-at-one and stuck-at-zero failure for any nibble in the data word as a non-correctable error. Stuck-at-one and stuck-at-zero for all 32 bits of the data word is also detected as a non-correctable error.

Memory and I/O Parity The TSC695FL handles parity towards memory and I/O in a special way. The processor can be programmed to use no parity, only parity or parity and EDAC protection towards memory and to use parity or no towards I/O. The signal used for the parity bit is DPA.

Memory Redundancy Programming the Memory Configuration Register, the TSC695FL provides chip selects for two redundant memory banks for replacement of faulty banks.

Memory Access Protection

- Unimplemented Areas - Access to all unimplemented memory areas are handled by the TSC695FL and detected as illegal.
- RAM Write Access Protection - The TSC695FL can be programmed to detect and mask write accesses in any part of the RAM. The protection scheme is enabled only for data area, not for the instruction area. The programmable write access protection is based on two segments.
- Boot PROM Write Protection - The TSC695FL supports a qualified PROM write for an 8-bit wide PROM and/or for a 40-bit wide PROM.

DMA

DMA Interface The TSC695FL supports Direct Memory Access (DMA). The DMA unit requests access to the processor bus by asserting the DMA request signal (\overline{DMAREQ}). When the DMA unit receives the \overline{DMAGNT} signal in response, the processor bus is granted. In case the processor is in the power-down mode the processor is permanent tri-stated, and a \overline{DMAREQ} will directly give a \overline{DMAGNT} . The TSC695FL includes a DMA session time-out function.

Bus Arbiter The TSC695FL always has the lowest priority on the system bus.

Traps A trap is a vectored transfer of control to the supervisor through a special trap table that contains the first four instructions of each trap handler. The base address of the table is established by supervisor and the displacement, within the table, is determined by the trap type. Two categories of traps can appear.

Synchronous Traps

Table 3. Synchronous Traps

Trap		Priority	Trap Type (tt)	Comments	
Reset		1	-	Sources: SYSRESET* pin software reset watchdog reset IU or System error reset	
Hardware Error	Non-restartable, imprecise error	2	2.1	64h	Severe error requiring a re-boot TSC695FL enters (if not masked) in halt or reset mode.
	Non-restartable, precise error		2.2	62h	Error not removable, PC & nPC OK TSC695FL enters (if not masked) in halt or reset mode.
	Register file error		2.3	65h	Special case of non-restartable, precise error. TSC695FL enters (if not masked) in halt or reset mode.
	Restartable, late error		2.4	63h	Retrying instruction but PC & nPC have to be re-adjusted TSC695FL enters (if not masked) in halt or reset mode.
	Restartable, precise error		2.5	61h	Retrying instruction TSC695FL enters (if not masked) in halt or reset mode.
Instruction access (Error on instruction fetch)		3	01h	Parity error on control bus Parity error on data bus Parity error on address bus Access to protected or unimplemented area Uncorrectable error in memory Bus time out Bus error	
Illegal Instruction		4	02h	-	
Privileged instruction		5	03h	-	
FPU disabled		6	04h	-	
Window	Overflow	7	05h	During SAVE instruction or trap taken	
	Underflow		06h	During RESTORE instruction or RETT instruction	
Memory address not aligned		8	07h	-	
FPU exception	Non-restartable error	9	9.1	08h	Severe error, cannot restart the instruction.
	Data bus error		9.2		Parity error on FPU data bus.
	Restartable error		9.3		Can be removed restarting the instruction.
	Sequence error		9.4		-
	Unimplemented FPop		9.5		-
	IEEE exceptions:		9.6		Invalid operation Division by zero Overflow Underflow Inexact

Table 3. Synchronous Traps (Continued)

Trap	Priority	Trap Type (tt)	Comments
Data access exception (Error on data load)	10	09h	Idem "instruction access" System register access violation
Tag overflow	11	0Ah	TADDccTV and TSubccTV instructions
Trap instructions	12	80h to FFh	Trap on integer condition codes (Ticc)

Table 4. Interrupts or Asynchronous Traps

Trap	Priority	Trap Type (tt)	Comments
Watchdog time-out	13	1Fh	Internal or external (EWDINT pin)
External INT 4	14	1Eh	EXTINTAK on only one of EXTINT[4:0]
Real time clock timer	15	1Dh	-
General purpose timer	16	1Ch	-
External INT 3	17	1Bh	EXTINTAK on only one of EXTINT[4:0]
External INT 2	18	1Ah	EXTINTAK on only one of EXTINT[4:0]
DMA time-out	19	19h	-
DMA access error	20	18h	-
UART Error	21	17h	-
Correctable error in memory	22	16h	Data read OK but source not updated
UART B Data ready Transmitter ready	23	15h	-
UART A Data ready Transmitter ready	24	14h	-
External INT 1	25	13h	EXTINTAK on only one of EXTINT[4:0]
External INT 0	26	12h	EXTINTAK on only one of EXTINT[4:0]
Masked hardware errors	27	11h	Logical OR of: IU hardware error masked IU error mode masked System hardware error masked

It is possible to mask each individual interrupt (except Watchdog time-out). The interrupts in the Interrupt Pending Register are cleared automatically when the interrupt is acknowledged.

By programming the Interrupt Shape Register, it is possible to define the external interrupts to be either active low or active high and to define the external interrupts to be either edge or level sensitive.

Timers

In software debug mode the timers are controlled by a system register bit and the external pin DEBUG.

General Purpose Timer

The General Purpose Timer (GPT) provides, in addition to a generalized counter function, a mechanism for setting the step size in which actual time counts are performed.

GPT is clocked by the internal system clock. They are possible to program to be either of single-shot type or periodical type and in both cases generate an interrupt when the delay time has elapsed. The current value of the scaler and counter of the GPT can be read.

Real Time Clock Timer

The only functional differences between the two timers are that the Real Time Clock Timer (RTCT) has an 8-bit scaler (16-bit scaler for GPT) and that the RTCT interrupt has higher priority than the GPT interrupt.

RTCT information is available on RTC output pin.

Watchdog Timer

Setting the external pin IWDE to Vcc enables the internal watchdog timer. Otherwise the watchdog function must be externally provided.

The watchdog is supplied from a separate external input (WDCLK). After reset, the timer is enabled and starts running with the maximum range. If the timer is not refreshed (reprogrammed) before the counter reaches zero value, an interrupt is sent. Simultaneously, the timer starts counting a reset time-out period. If the timer is not acknowledged before the reset time-out period elapses, a reset is applied to TSC695FL.

UARTs

Two full duplex asynchronous receiver transmitters (UART) are included. In software debug mode the UART's are controlled by system register bits.

The data format of the UART's is eight bits. It is possible to choose between even or odd parity, or no parity, and between one and two stop bits. The UART's provide double buffering, i.e. each UART consists of a transmitter holding register, a receiver holding register, a transmitter shift register, and a receiver shift register. Each of these registers are 8-bit wide. For each UART a RX and TX Register is provided. The UART's generate an interrupt each time a byte has been received or a byte has been sent. There is another interrupt to indicate errors.

The baud rate of both the UART's is programmable. The clock is derived either from the system clock or can use the watchdog clock.

General Purpose Interface

The General Purpose Interface (GPI) is an 8-bit parallel I/O port. Each pin can be configured as an input or an output.

A falling or rising edge detection is made on each selected GPI inputs. Every input transition on GPI generates an external positive pulse on GPIINT pin of two SYSCLK width.

Execution Modes

Reset Mode

Reset mode is entered when:

- The $\overline{\text{SYSRES}}$ input is asserted
- Software reset which is caused by the software writing to a Software Reset Register,
- Watchdog reset which is caused by a Watchdog counter time-out
- Error reset which is caused by a hardware parity error

This $\overline{\text{RESET}}$ output has a minimum of 1024 SYSCLK width to allow the usage of flash memories.

The error and Reset Status Register contain the source of the last processor reset.

Run Mode

In this mode the IU/FPU is executing, while all peripherals are running (if software enabled).

System Halt Mode

System Halt mode is entered when the $\overline{\text{SYSHALT}}$ input is asserted. In this mode, the IU and FPU are frozen, while the timers (including the internal watchdog timer) and UART's are stopped.

Power Down Mode

This mode is entered by writing to the Power Down Register. In this mode, the IU and FPU are frozen. The TSC695FL leaves the power-down mode if an external interrupt is asserted.

Error Halt Mode

Error Halt mode is entered under the following circumstances:

- A internal hardware parity error.
- The IU enters error mode.

The only way to exit Error Halt Mode is through Cold Reset by asserting $\overline{\text{SYSRESET}}$.

Error Handler

The TSC695FL has one error output signal ($\overline{\text{SYSERR}}$) which indicates that an unmasked error has occurred. Any error signalled on the error inputs from the IU and the FPU is latched and reflected in the Error and Reset Status Register. By default, an error leads to a processor halt.

Parity Checking

The TSC695FL includes:

- Parity checking and generation (if required) on the external data bus,
- Parity checking on the external address bus,
- Parity checking on ASI and SIZE,
- Parity checking and generation on all system registers,
- Parity generation and checking on the internal control bus to the IU,

All external parity checking can be disabled using the $\overline{\text{NOPAR}}$ signal.

System Clock

The TSC695FL uses CLK2 clock input directly and creates a system clock signal by dividing CLK2 by two. It drives SYSCLK pin with a nominal 50% duty cycle for the application. It is highly recommended that only SYSCLK rising edge is used as reference as far as possible.

System Availability

The SYSAV bit in the Error and Reset Status Register can be used by software to indicate system availability.

Test Mode

The TSC695FL includes a number of software test facilities such as EDAC test, Parity test, Interrupt test, Error test and a simple Test Access Port. These test functions are controlled using the Test Control Register.

Test and Diagnostic Hardware Functions

A variety of TSC695FL test and diagnostic hardware functions, including boundary scan, internal scan, clock control and On-chip Debugger, are controlled through an IEEE 1149.1 (JTAG) standard Test Access Port (TAP).

Test Access Port

The TAP interfaces to the JTAG bus via 5 dedicated pins on the TSC695FL chip. These pins are:

- TCK (input): Test Clock
- TMS (input): Test Mode Select
- TDI (input): Test Data Input
- TDO (output): Test Data Output
- $\overline{\text{TRST}}$ (input): Test Reset

Instruction Register

Five standard instructions are supported by the TSC695FL TAP.

Binary Value	Name of Instruction	Data Register	Scan Chain Accessed
00. 0000	EXTEST	Boundary Scan Register	Boundary scan chain
00. 0001	SAMPLE/PRELOAD	Boundary Scan Register	Boundary scan chain
00. 0011	INTEST	Boundary Scan Register	Boundary scan chain
11. 1111	BYPASS	Bypass Register	Bypass register
10. 0000	IDCODE	Device ID Register	ID register scan chain

Debugging

The design is highly testable with the support of an On-Chip Debugger (OCD), an internal and boundary scan through JTAG interface.

Electrical Characteristics

Absolute Maximum Ratings

Military Range.....	-55°C to +125°C
Storage Temperature	-65°C to +150°C
Supply Voltage.....	-0.5V to +7.0V
Input Voltage.....	-0.5V to +7.0V

Note: Stresses at or above those listed under “Absolute Maximum Ratings” may cause permanent damage to the device. This is a stress rating only and functional operation of the device at these or any other conditions above those indicated in the operational sections of this specification is not implied. Exposure to absolute maximum rating conditions may affect device reliability.

DC Characteristics

Table 5. DC Characteristics at VDD 3.3V ± 0.15V

Symbol	Parameter	Min	Typ	Max	Unit	Test Conditions
V _{IL trigger}	Input Low Voltage for trigger input	–	–	1	V	V _{CC} = 3.15 to 3.45V
V _{IH trigger}	Input High Voltage for trigger input	1.5	–	–	V	V _{CC} = 3.15 to 3.45V
ΔVT	Input Hysteresis for trigger input	–	0.3	–	V	V _{CC} = 3.15 to 3.45V
V _{IL TTL}	Input Low Voltage for TTL input	–	–	0.8	V	V _{CC} = 3.15 to 3.45V
V _{IH TTL}	Input High Voltage for TTL input	2	–	–	V	V _{CC} = 3.15 to 3.45V
V _{OL400 pF}	Output Low Voltage for 400 pF buffer	–	–	0.4	V	V _{CC} = 3.15 to 3.45V I _{OL} = 9 mA
V _{OH400 pF}	Output High Voltage for 400 pF buffer	2.4	–	–	V	V _{CC} = 3.15 to 3.45V I _{OH} = -6 mA
V _{OL150 pF}	Output Low Voltage for 150 pF buffer	–	–	0.4	V	V _{CC} = 3.15 to 3.45V I _{OL} = 3 mA
V _{OH150 pF}	Output High Voltage for 150 pF buffer	2.4	–	–	V	V _{CC} = 3.15 to 3.45V I _{OH} = -2 mA
I _{CCOP}	Operating Supply Current for core processor	–	–	100	mA	V _{CC} = 3.45V, f = 15 MHz
I _{CCPD}	Power Down Supply Current for core processor	–	–	10	mA	V _{CC} = 3.45V, f = 15 MHz
I _{IL}	Low Level Input Current	-10	–	10	μA	V _{CC} = 3.45V, V _{IN} = 0
I _{IH}	High-Level Input Current	-10	–	10	μA	V _{CC} = 3.45V; V _{IN} = V _{CC}
I _{ILPU}	Low Level Input Pull-up Current	10	–	350	μA	V _{CC} = 3.45V; V _{IN} = 0

Capacitance Ratings

Parameter	Description	Max
C _{IN}	Input Capacitance	7 pF
C _{OUT}	Output Capacitance	8 pF
C _{IO}	Input/Output Capacitance	8 pF

AC Characteristics

Table 6. AC Characteristics (SYSCLK Freq. = 15 MHz - 3.3V ± 0.15V) C_{load} = 50 pF, V_{ref} = V_{CC}/2

Parameter	Min (ns)	Max (ns)	Comment	Reference Edge
t1	33	–	CLK2 period	–
t2	66	–	SYSCLK period	–
t3	16	–	CLK2 high and low pulse width	–
t4_1	–	10	RA(31:0) RAPAR RSIZE RLDSTO output delay	SYSCLK+
t4_2	–	16	LOCK Output delay	SYSCLK+
t5	–	18	MEMCS*(9:0) ROMCS* EXMCS* output delay	SYSCLK+
t6	–	18	DDIR DDIR* output delay	SYSCLK+
t7	–	36.5	MEMWR* IOWR* output delay formula: 20 ns + 1/4 t2	SYSCLK- or SYSCLK+
t8	–	31.5	OE* HL output delay formula: 15 ns + 1/4 t2	SYSCLK+
t9_1	16	–	Data setup time during load	SYSCLK+
t9_2	13	–	Data setup time during load NOPAR = 0 rpa = rec = either 0 or 1	SYSCLK+
t10	7	–	Data hold time during load	SYSCLK+
t11	–	44	Data output delay	SYSCLK-
t12	18	–	Data output valid to HZ – guaranteed by design	SYSCLK+
t13	–	30	CB output delay	SYSCLK+
t14	–	25	ALE* output delay	SYSCLK-
t15	–	32.5	BUFFEN* HL output delay formula: 16 ns + 1/4 t2	SYSCLK+
t16	–	20	MHOLD* output delay – guaranteed by design	SYSCLK+
t17	–	20	MDS* DRDY* output delay	SYSCLK+
t20	–	20	MEXC* output delay	SYSCLK-
t21	15	–	RASI(3:0) RSIZE(1:0) RASPAR setup time	SYSCLK+
t22	0	–	RASI(3:0) RSIZE(1:0) RASPAR hold time	SYSCLK+

Table 6. AC Characteristics (SYSCLK Freq. = 15 MHz - 3.3V ± 0.15V) C_{load} = 50 pF, V_{ref} = V_{CC}/2 (Continued)

Parameter	Min (ns)	Max (ns)	Comment	Reference Edge
t23	–	20	BOOT PROM address output delay	SYSCLK+
t24	15	–	BUSRDY* setup time	SYSCLK+
t25	0	–	BUSRDY* hold time	SYSCLK+
t27	–	20	IOSEL output delay	SYSCLK+ HL SYSCLK- LH
t28	15	33	DMAAS setup time formula of max: $\frac{1}{2}t_2$	SYSCLK+
t29	0	33	DMAAS hold time formula of max: $\frac{1}{2}t_2$	SYSCLK-
t30	15	–	DMAREQ* setup time	SYSCLK+
t31	–	20	DMAGNT* output delay	SYSCLK+
t32	15	–	RA(31:0) RAPAR CPAR setup time	SYSCLK+
t33	0	–	RA(31:0) RAPAR CPAR hold time	SYSCLK+
t36	100	–	TCK period	–
t37	10	–	TMS setup time	TCK+
t38	4	–	TMS hold time	TCK+
t39	10	–	TDI setup time	TCK+
t40	10	–	TDI hold time	TCK+
t41	–	20	TDO output delay	TCK-
t46	–	35	INULL output delay	SYSCLK+
t48	–	35	RESET* CPUHALT* output delay	SYSCLK+
t49	–	20	SYSERR* SYSAV output delay	SYSCLK+
t50	–	35	IUERR* output delay	SYSCLK+
t52	15	–	EXTINT(4:0) setup time	SYSCLK-
t53	0	–	EXTINT(4:0) hold time	SYSCLK+
t54	–	20	EXTINTACK output delay	SYSCLK+
t56	–	14	OE* LH output delay (no DMA mode)	SYSCLK+
t57	–	15	BUFFEN* LH output delay	SYSCLK+
t60	–	35	INST output delay	SYSCLK+
t61	30.5	–	Data output delay to low-Z – guaranteed by design formula: $14\text{ ns} + \frac{1}{4}t_2$	SYSCLK+

Figure 3. 150 pF Buffer Response (Data from simulation)

DTplh (Vref Vcc/2)

Table 1 : Pad 150pF - 3,15V up to 3,45V

Cload	DTplh min	DTplh typ	DTplh max
50	0	0	0
100	2,7	4,05	7,25
150	5,2	8,4	14,35
200	7,95	12,5	21,45
250	10,65	16,75	28,55

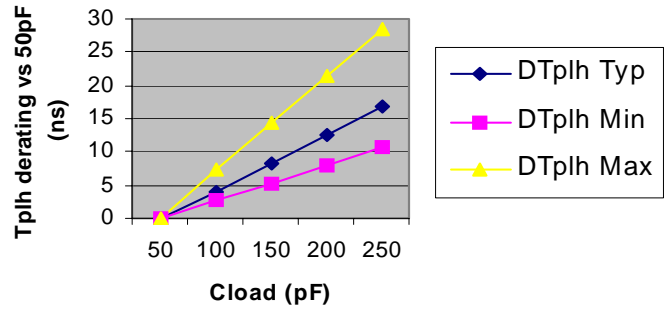

DTphl (Vref Vcc/2)

Table 2 : Pad 150pF - 3,15V up to 3,45V

Cload	DTphl min	DTphl typ	DTphl max
50	0	0	0
100	2,65	3,5	5,7
150	5	6,95	11,15
200	7,35	10,45	15,6
250	9,95	13,85	18,45

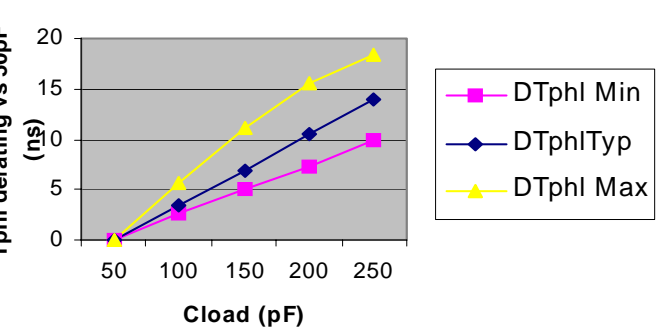

Trise (Vref 10%-90%Vcc)

Table 3 : Pad 150pF - 3,15V up to 3,45V

Cload	Trise min	Trise typ	Trise max
50	4,95	7,3	12,55
100	8,4	13,15	23,5
150	12,25	19,3	34,3
200	15,9	25,55	45,3
250	19,85	31,8	56,4

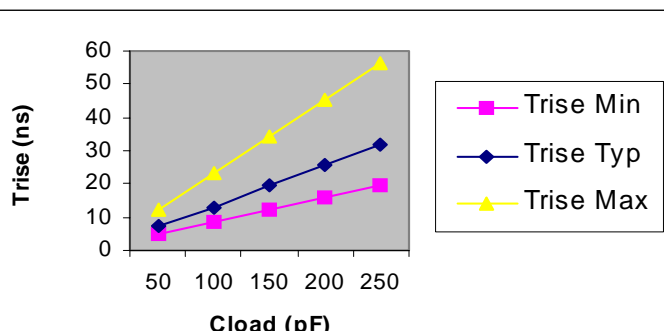

Tfall (Vref 10%-90%Vcc)

Table 4 : Pad 150pF - 3,15V up to 3,45V

Cload	Tfall min	Tfall typ	Tfall max
50	4,45	6,1	11,45
100	7,2	12	21,85
150	11,35	18,25	32,45
200	15,8	24,8	43,1
250	20,35	31,4	53,65

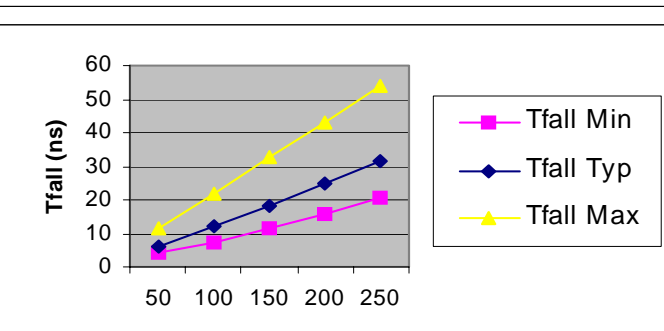
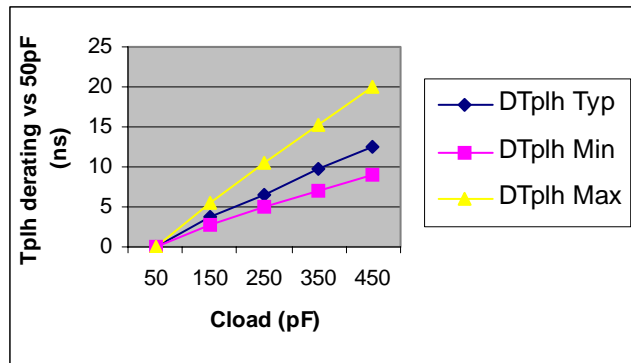

Figure 4. 400 pF Buffer Response (Data from simulation)

DTplh (Vref Vcc/2)

Table 5 : Pad 400pF - 3,15V up to 3,45V

Cload	DTplh min	DTplh typ	DTplh max
50	0	0	0
100	2,8	3,65	5,4
150	5,1	6,55	10,4
200	6,95	9,65	15,2
250	8,9	12,5	20,05



DTphi (Vref Vcc/2)

Table 6 : Pad 400pF - 3,15V up to 3,45V

Cload	DTphi min	DTphi typ	DTphi max
50	0	0	0
100	3,6	3,9	5,1
150	6,3	6,95	9,7
200	8,85	10	14,1
250	11,5	12,95	18,25

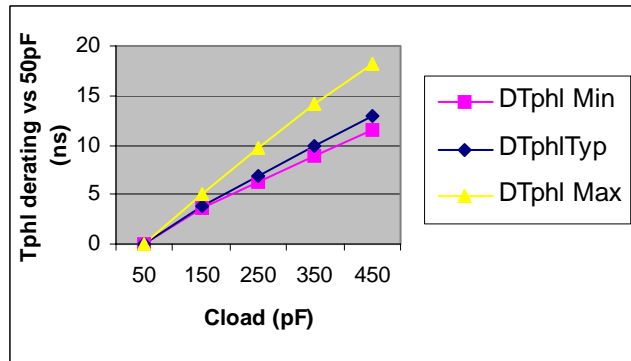

Trise (Vref 10%-90%Vcc)

Table 7 : Pad 400pF - 3,15V up to 3,45V

Cload	Trise min	Trise typ	Trise max
50	3	3,9	5,7
100	5,8	7,7	12,2
150	8,1	11,6	19,15
200	10,7	15,5	26,25
250	13,15	19,5	33,65

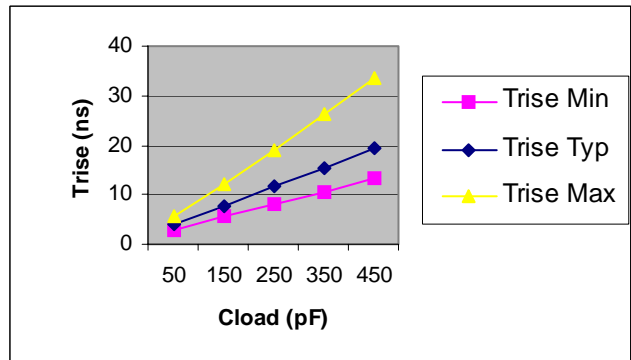

Tfall (Vref 10%-90%Vcc)

Table 8 : Pad 400pF - 3,15V up to 3,45V

Cload	Tfall min	Tfall typ	Tfall max
50	2,95	3,55	5
100	5,5	6,85	10,9
150	7,85	10,35	17,75
200	10,5	14,3	25
250	13,45	18,55	32,35

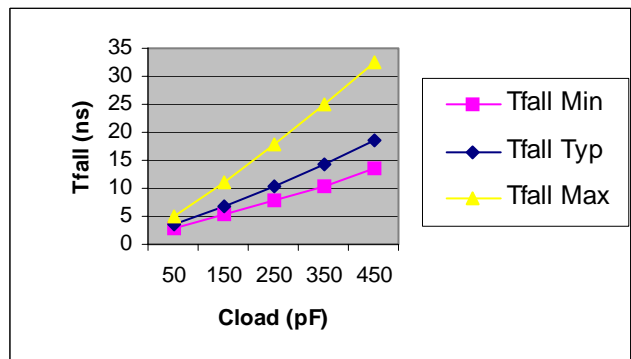
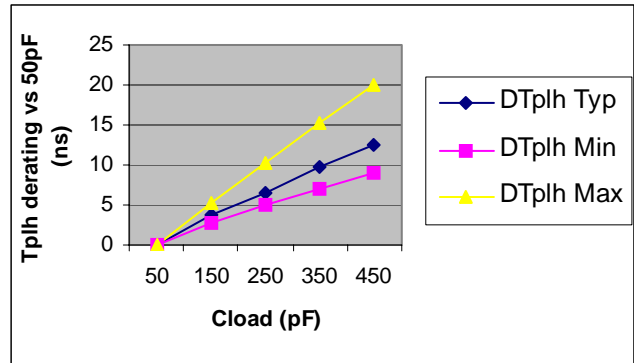

Figure 5. OE*/400 pF Buffer Response (Data from simulation)

DTplh (Vref Vcc/2)

Table 9 : Pad 400pF - OE* - 3,15V up to 3,45V

Cload	DTplh min	DTplh typ	DTplh max
50	0	0	0
100	2,75	3,7	5,35
150	5,1	6,6	10,35
200	6,95	9,7	15,2
250	8,9	12,55	20,05



DTphi (Vref Vcc/2)

Table 10 : Pad 400pF - OE* - 3,15V up to 3,45V

Cload	DTphi min	DTphi typ	DTphi max
50	0	0	0
100	2,95	3,45	4,7
150	5,1	6,1	8,75
200	6,95	8,6	12,7
250	8,7	11,1	16,45

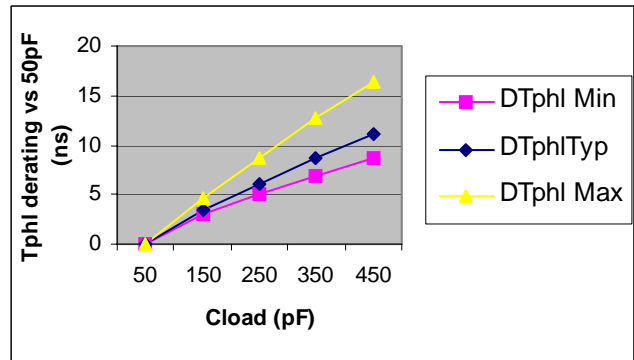

Trise (Vref 10%-90%Vcc)

Table 11 : Pad 400pF - OE* - 3,15V up to 3,45V

Cload	Trise min	Trise typ	Trise max
50	3	3,9	5,7
100	5,8	7,7	12,2
150	8,1	11,6	19,15
200	10,7	15,5	26,25
250	13,15	19,5	33,65

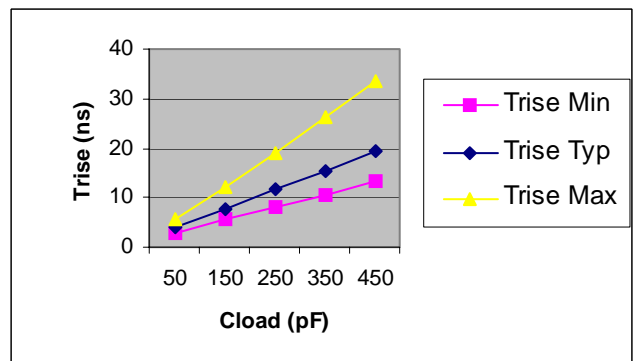

Tfall (Vref 10%-90%Vcc)

Table 12 : Pad 400pF - OE* - 3,15V up to 3,45V

Cload	Tfall min	Tfall typ	Tfall max
50	2,45	3,25	4,7
100	4,7	6,1	10,05
150	6,4	9,15	16,25
200	8,5	12,45	23,15
250	10,55	16,2	30,2

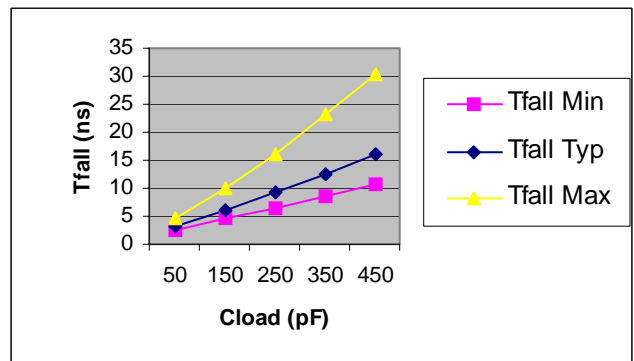

Timing Diagrams

Figure 6. RAM Fetch, RAM Load and RAM Store Sequence - n Waitstates for Read, m Waitstates for Write

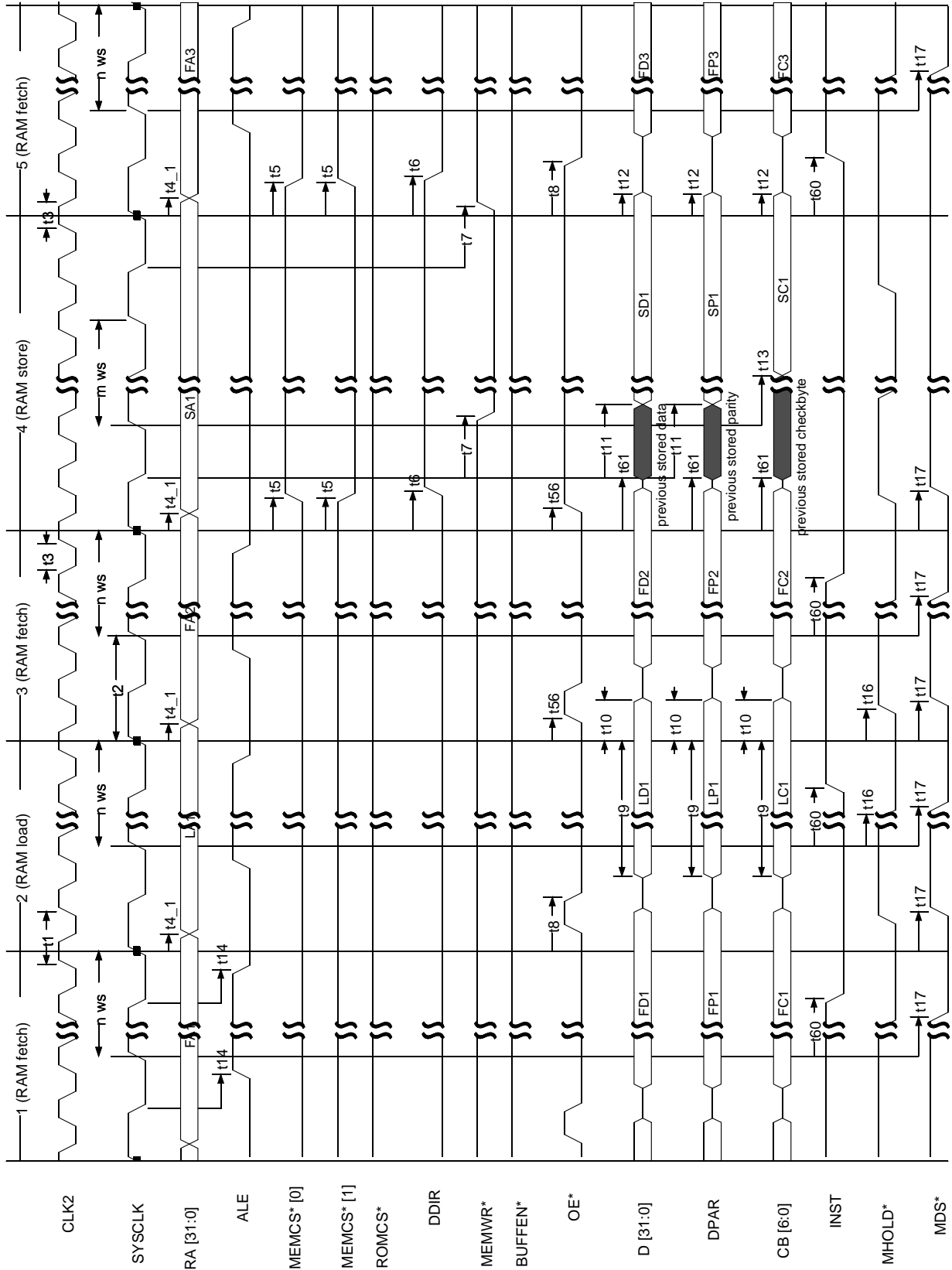

Figure 7. RAM "Atomic-load-store" byte Sequence - 0 Waitstate

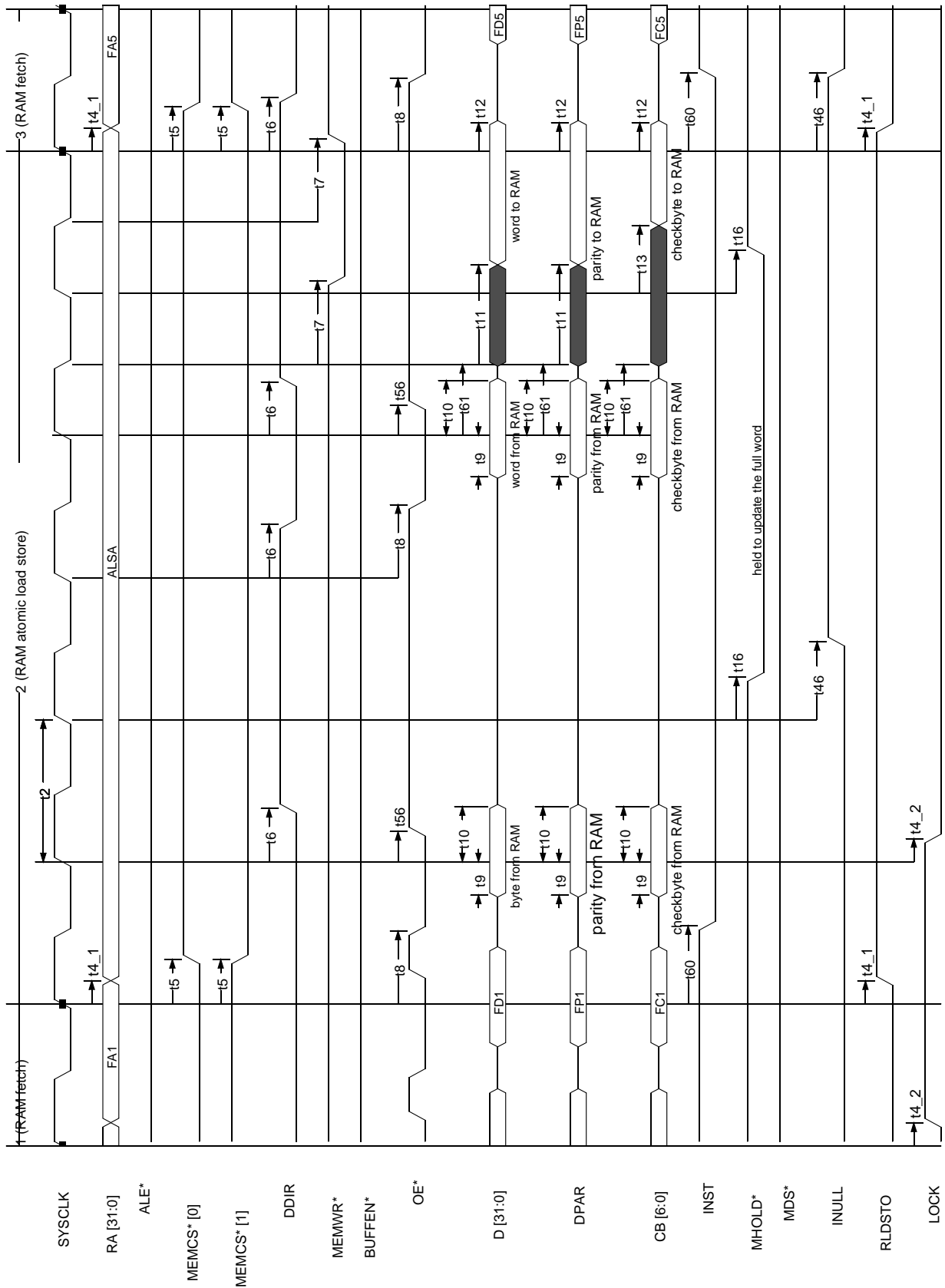

Figure 8. RAM Load-double and RAM Store-double Sequence - 0 Waitstate

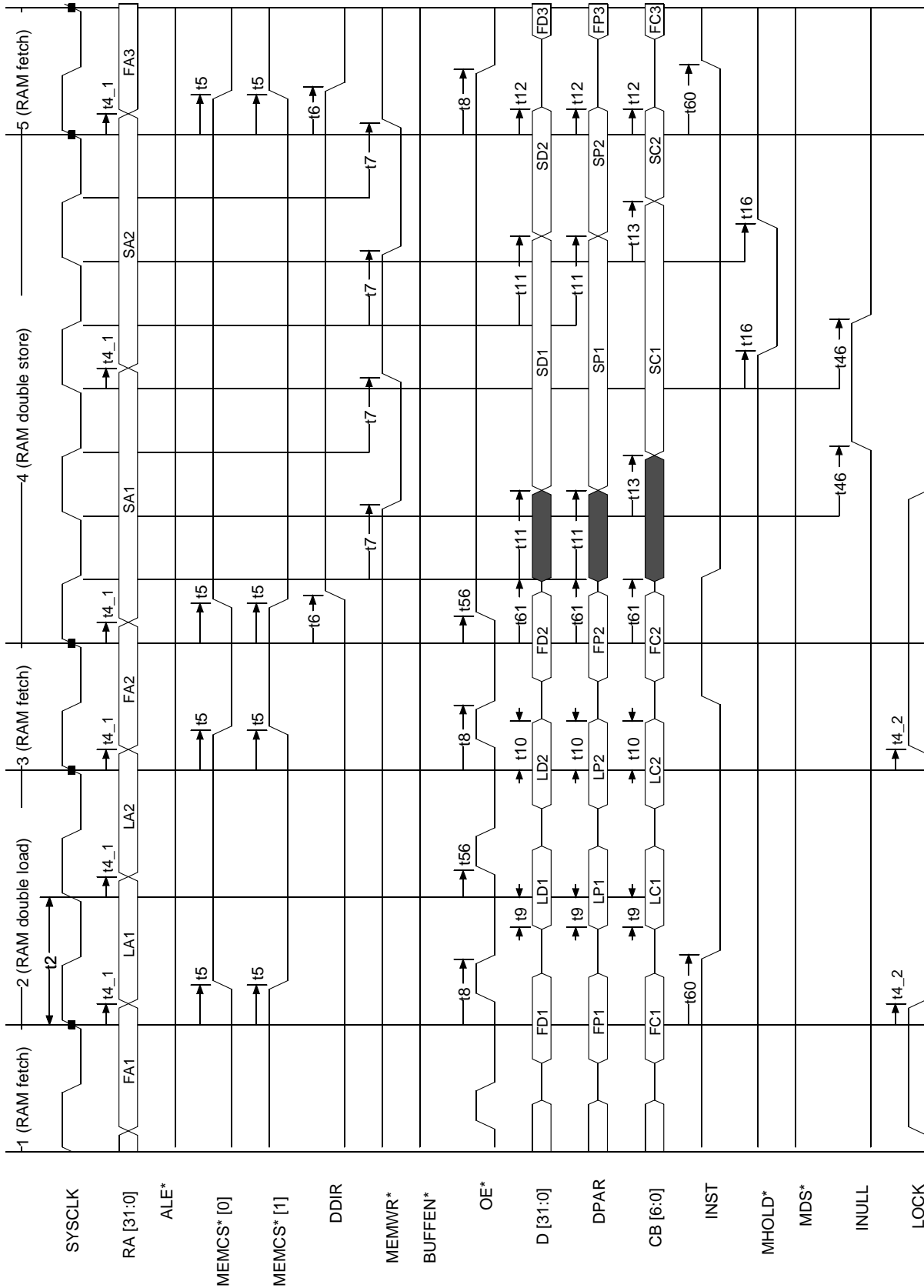

Figure 9. RAM Load with Correctable Error - 0 Waitstate

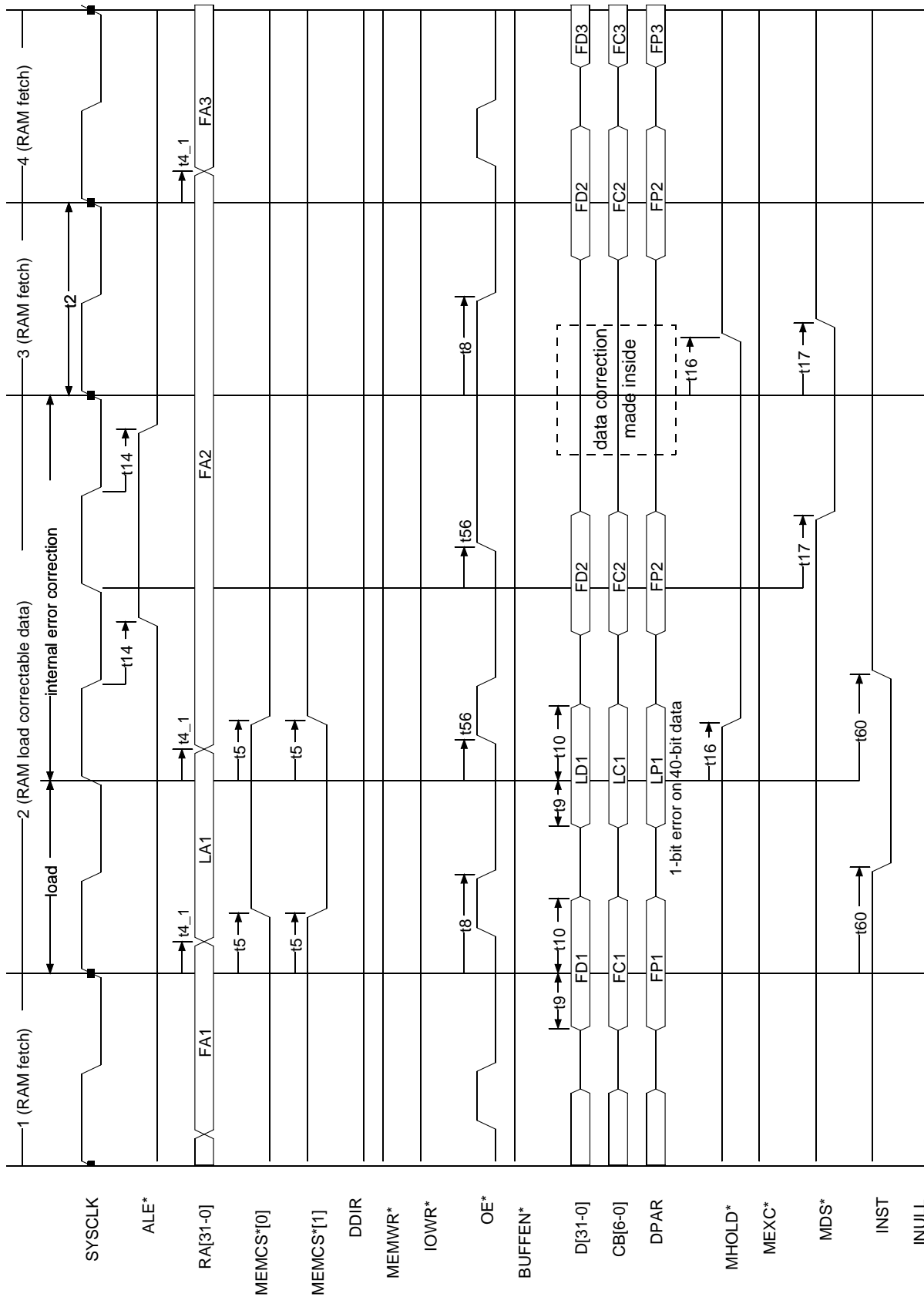

Figure 10. RAM Load with Uncorrectable Error - 0 Waitstate

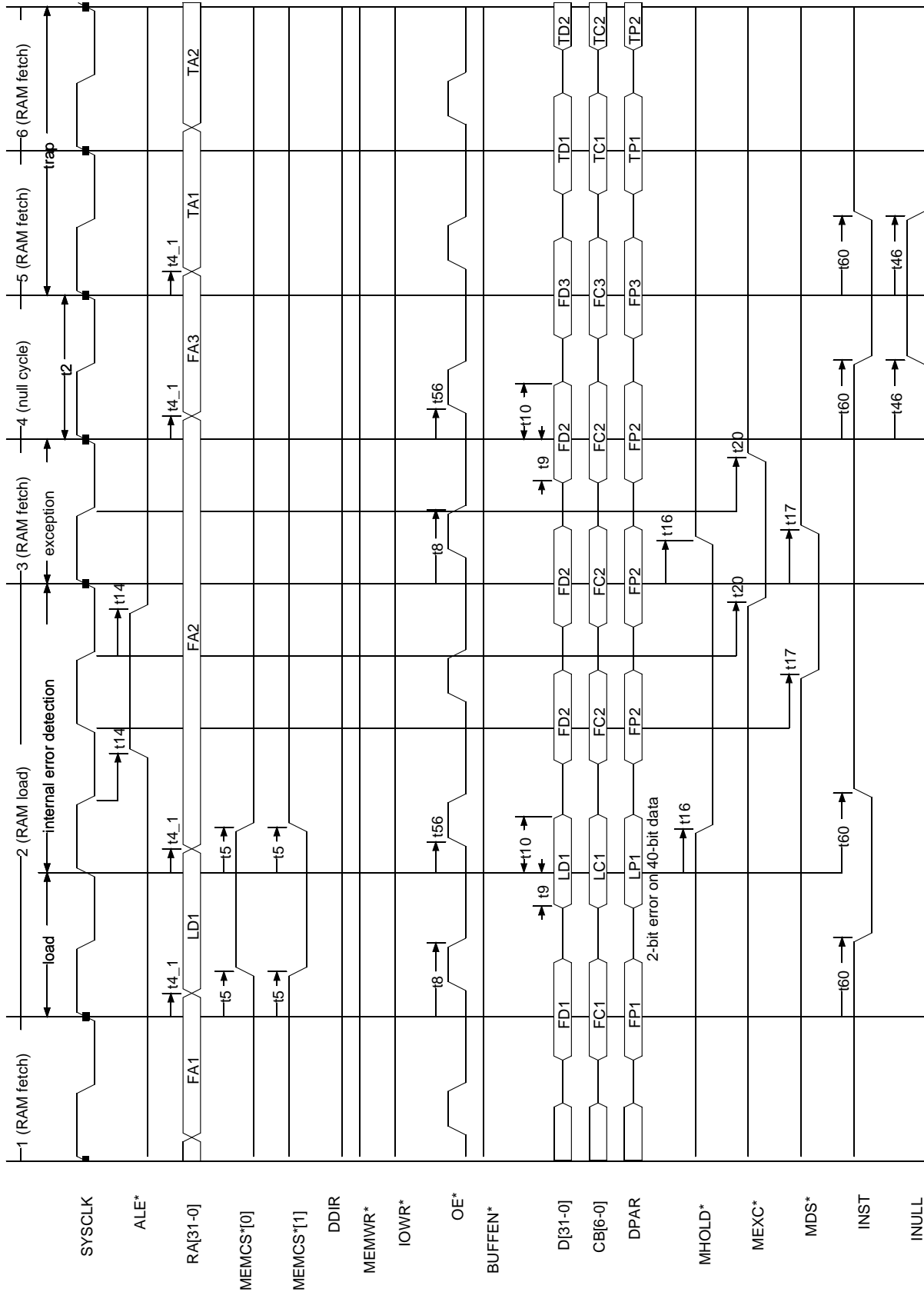

Figure 11. RAM Load with Unimplemented Area Access - 0 Waitstate

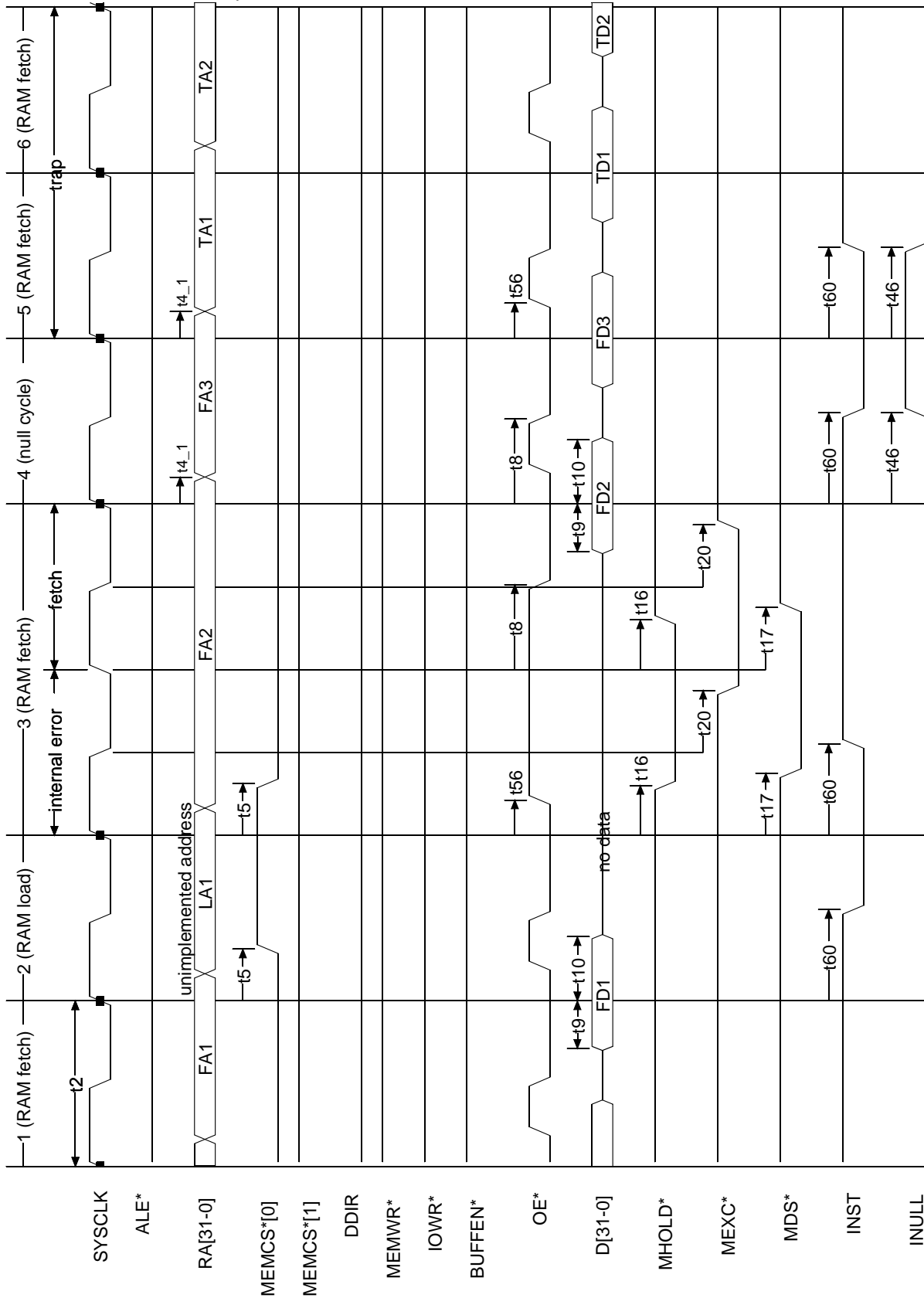

Figure 12. I/O Store Sequence with BUSRDY* and n Waitstates (Timing for 0 Waitstate = Timing for 1 Waitstates)

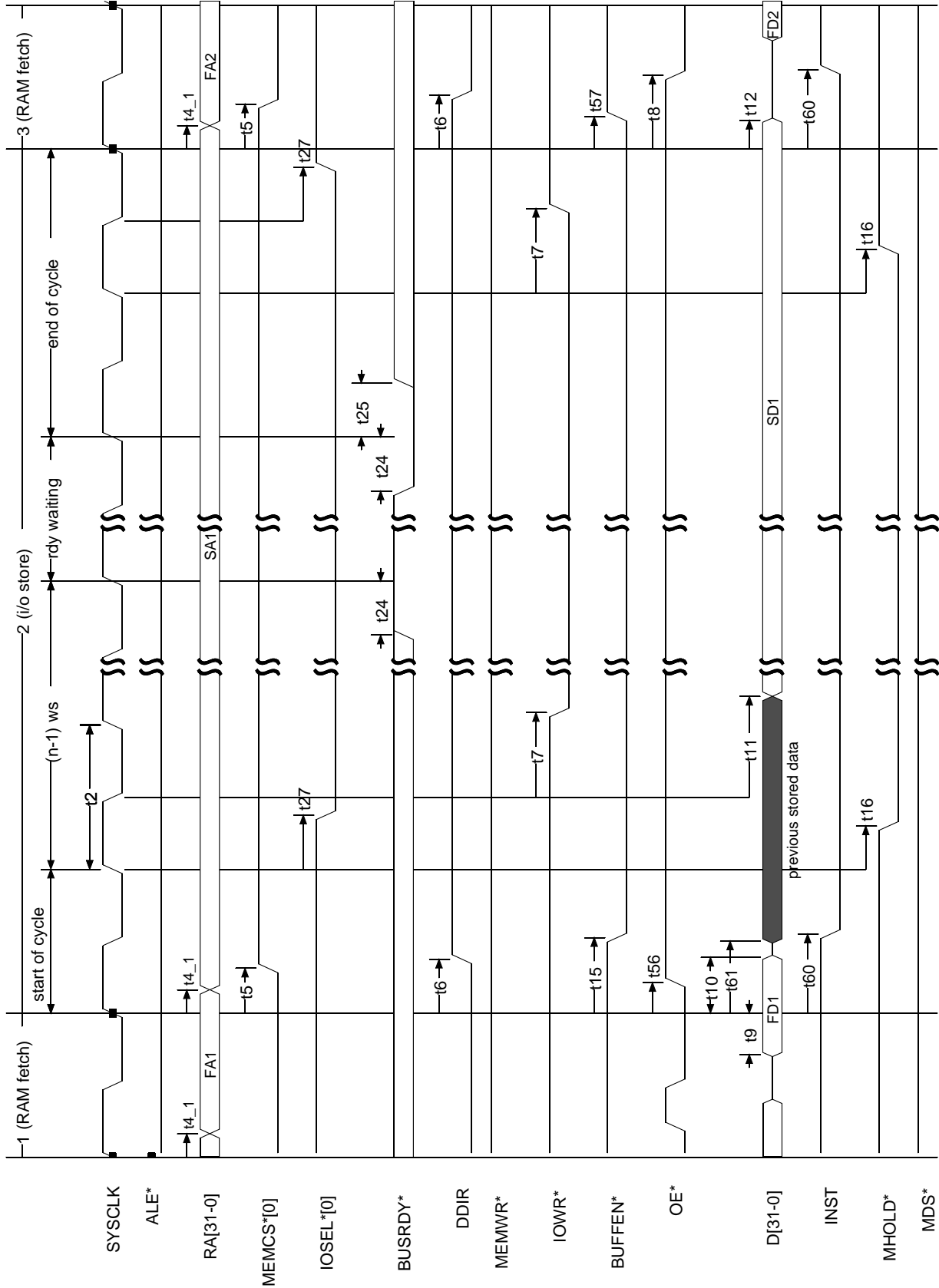

Figure 13. I/O Load Sequence with BUSRDY* and n Waitstates (Timing for 0 ws = Timing for 1 ws)

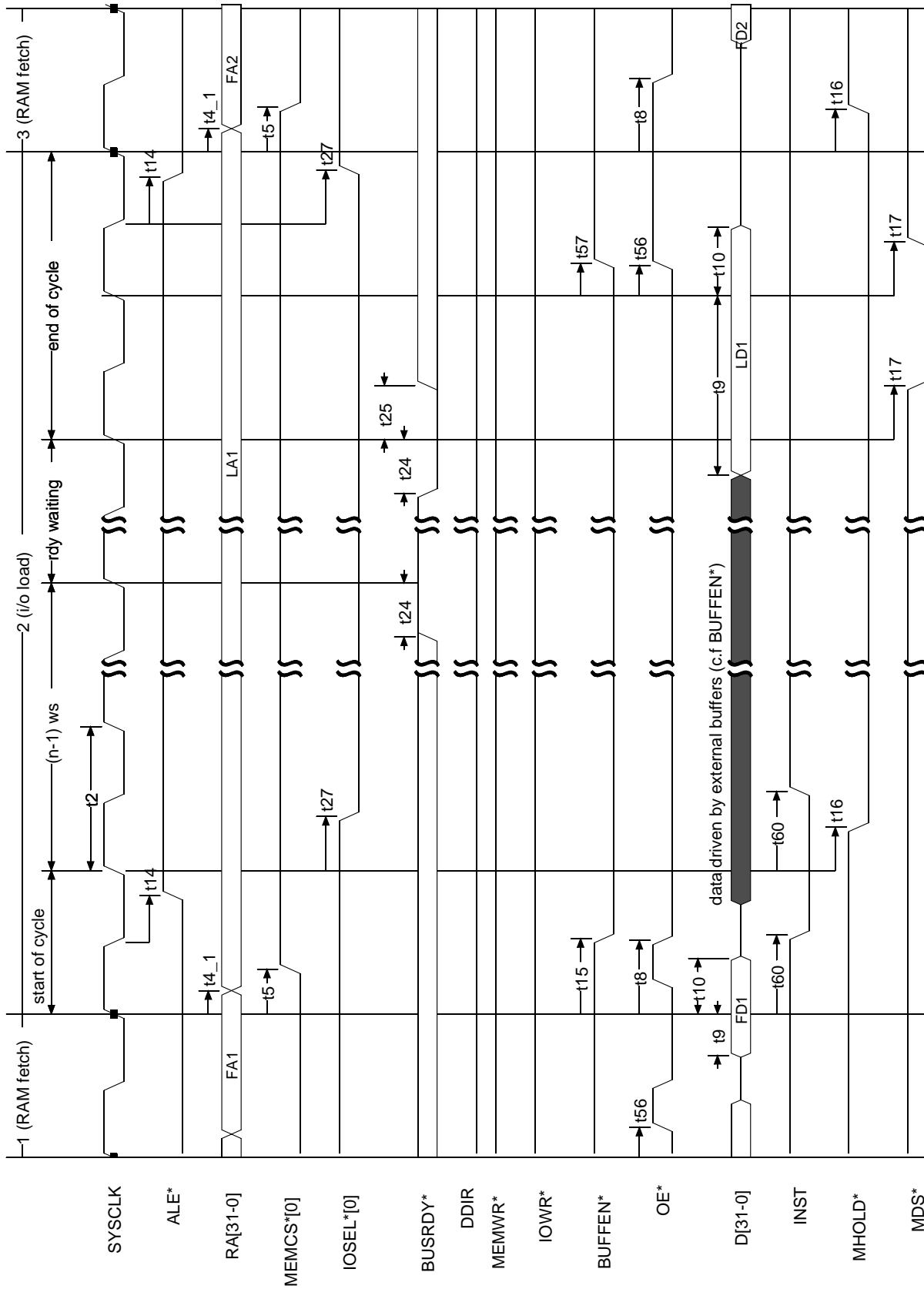

Figure 14. EXCHANGE RAM Store with BUSDRY* and n Waitstates

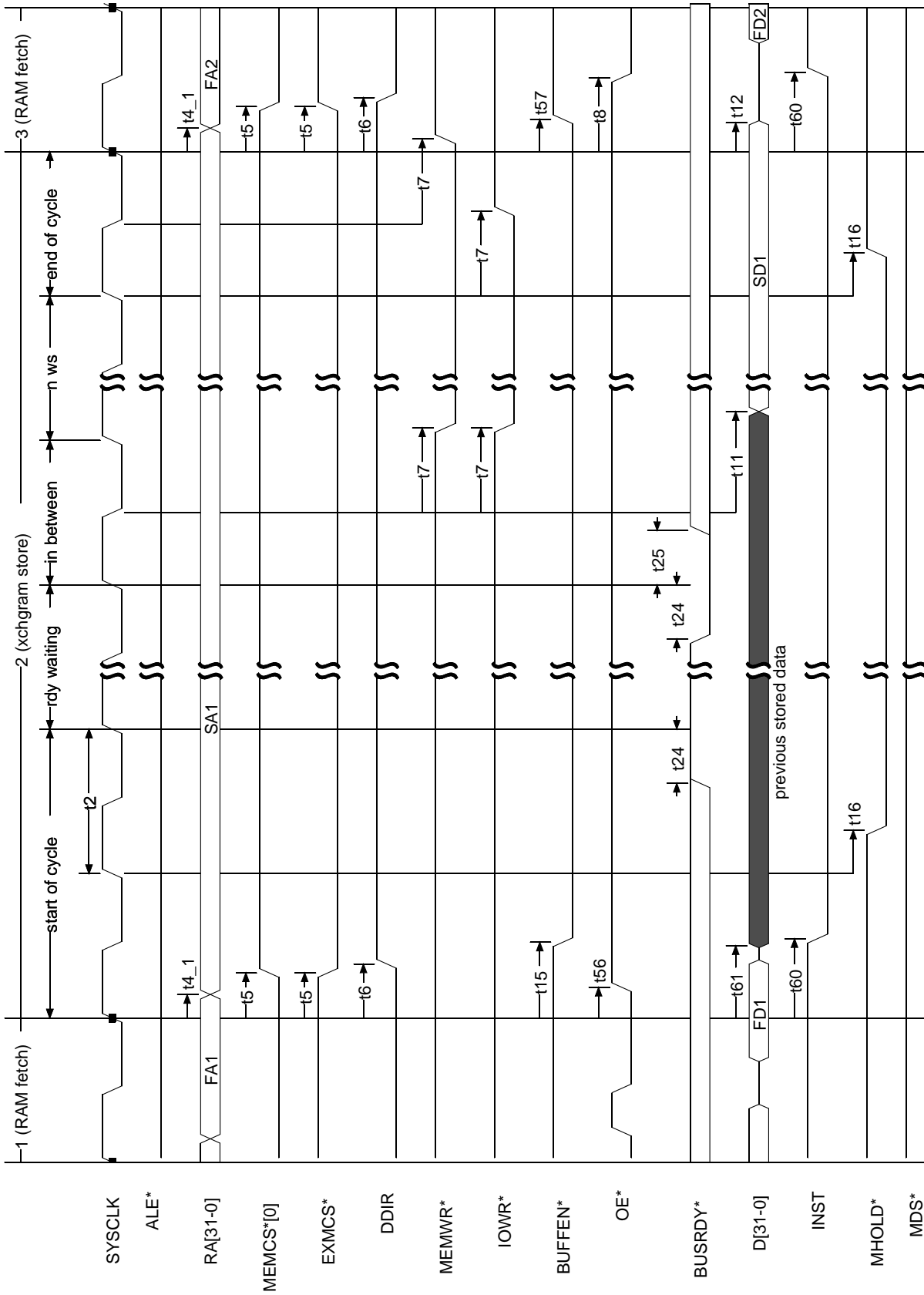

Figure 15. EXCHANGE RAM Load with BUSDRY* and n Waitstates

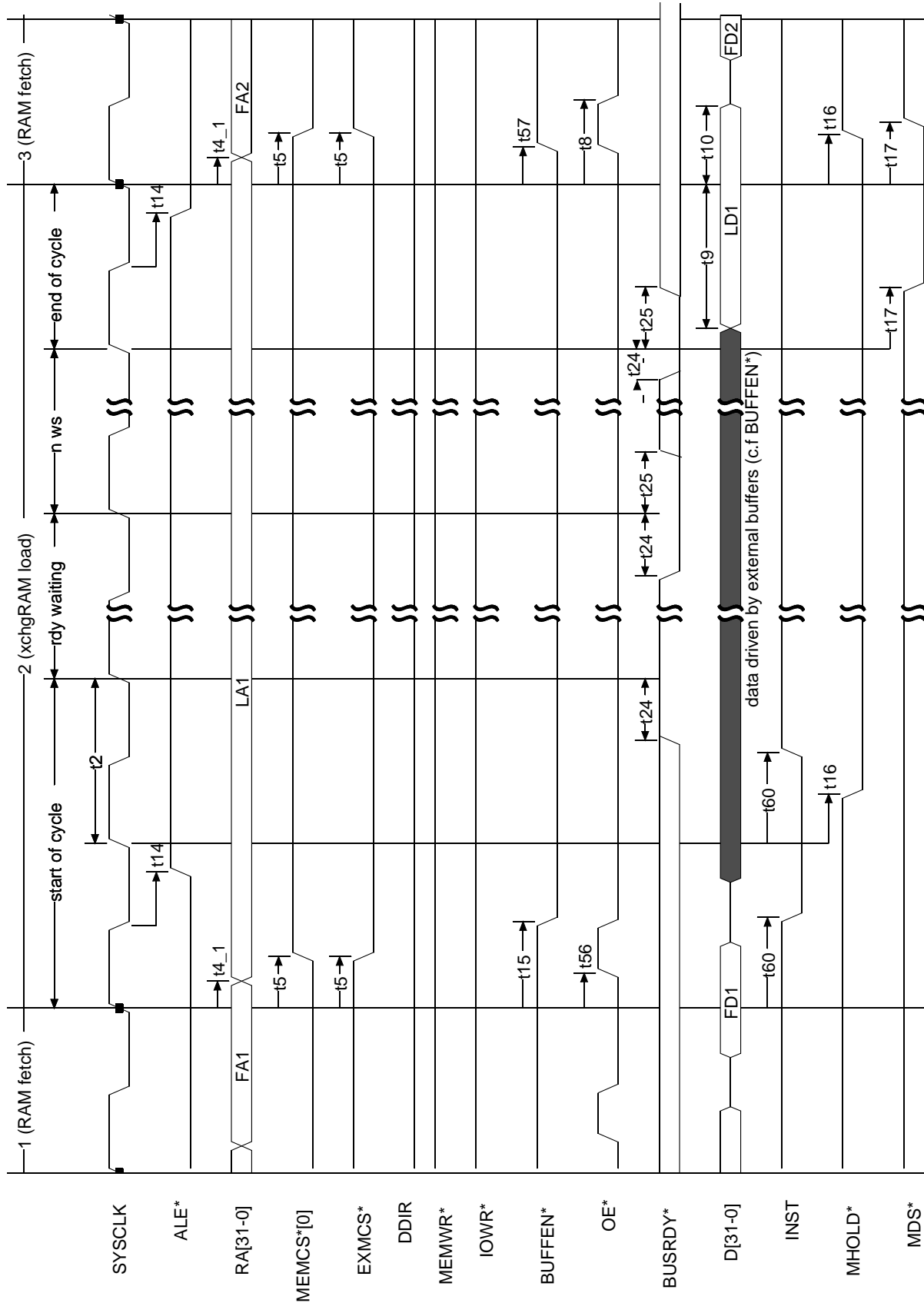

Figure 16. 8-bit BOOT PROM Fetch (or Load Word) - n Waitstates

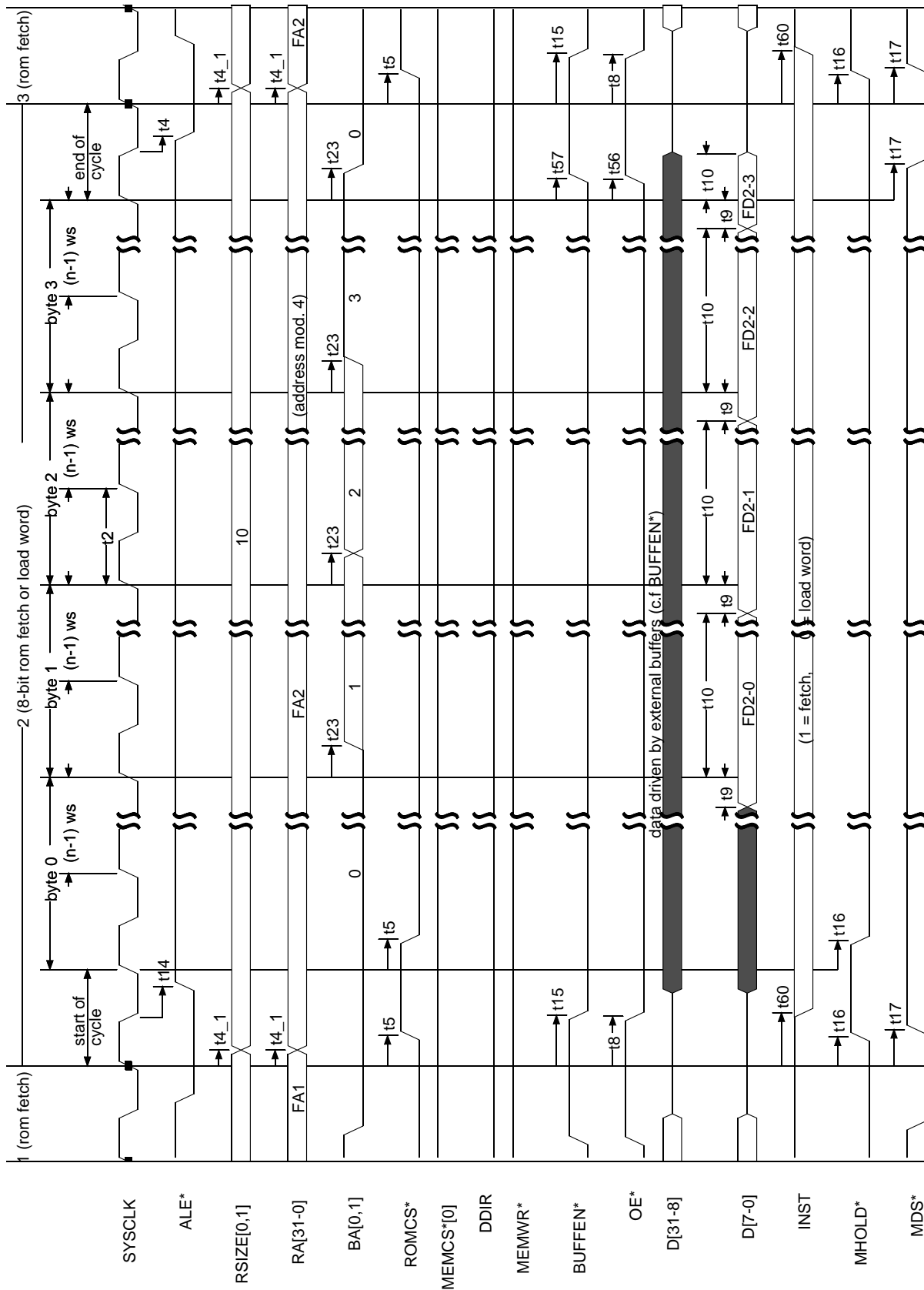

Figure 17. 8-bit BOOT PROM 2x Store byte - n Waitstate

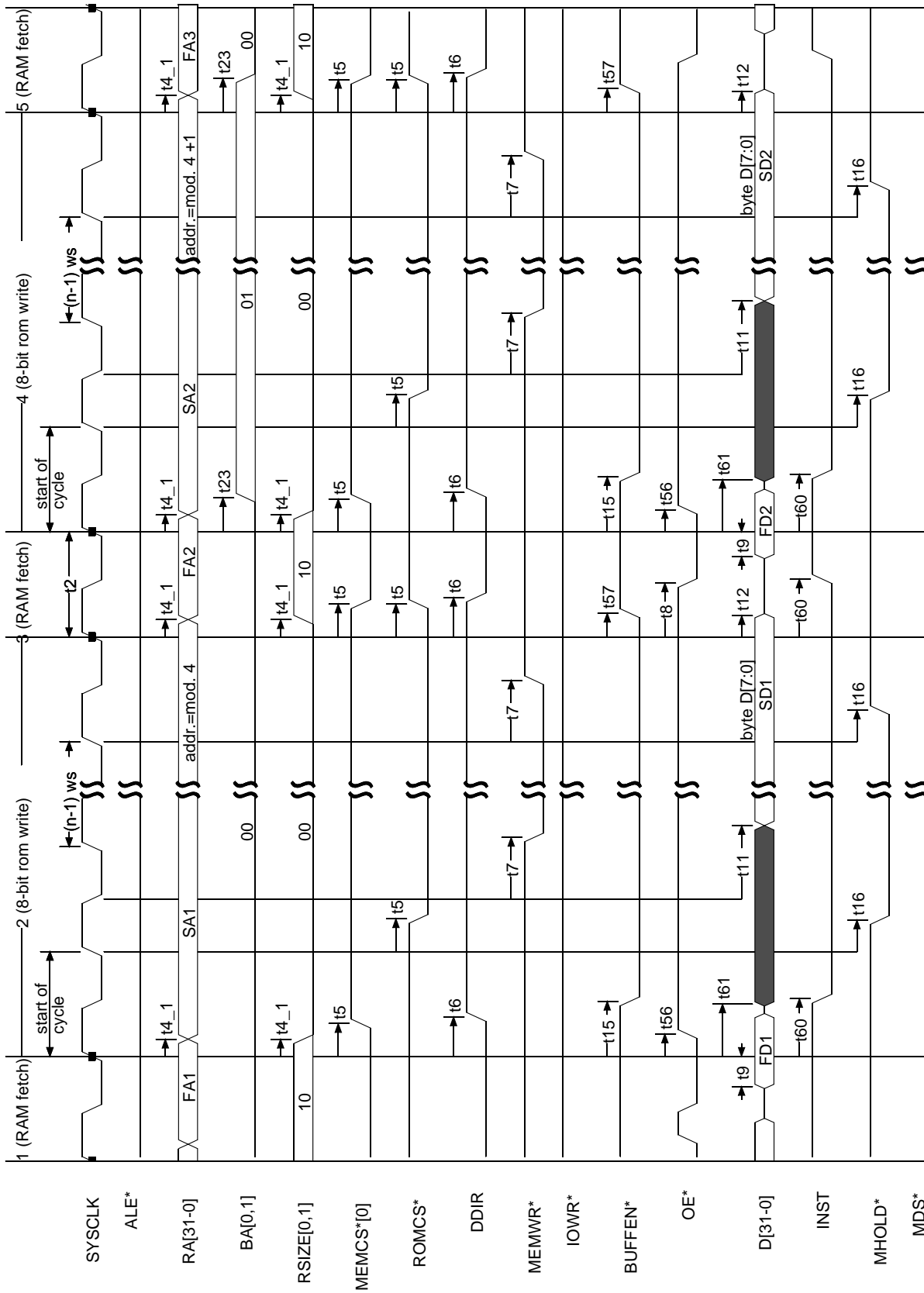

Figure 18. DMA RAM load with or without Correctable Error and DMA RAM Store - 0 Waitstates

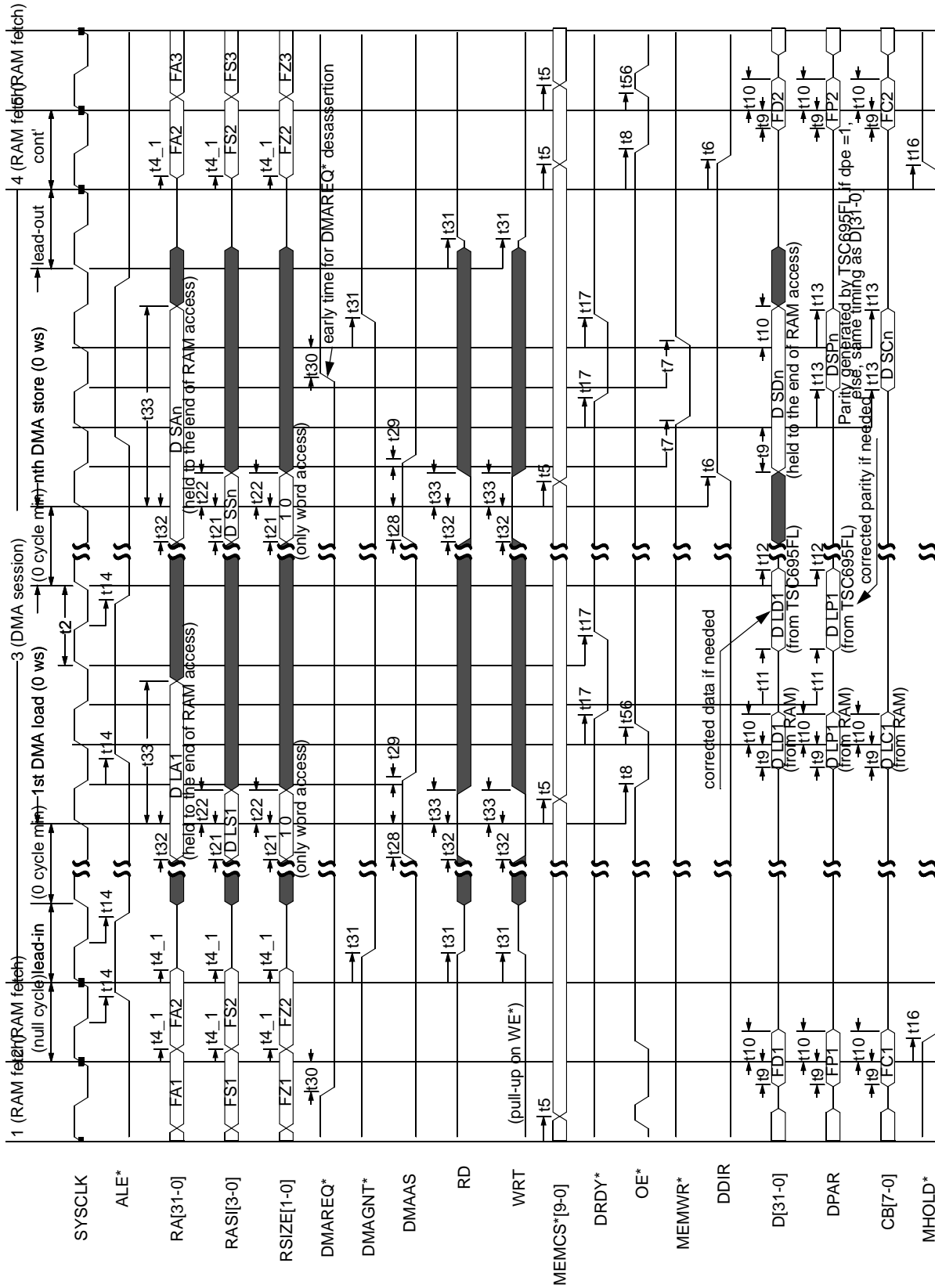

Figure 19. Edge Triggered Interrupt Timing

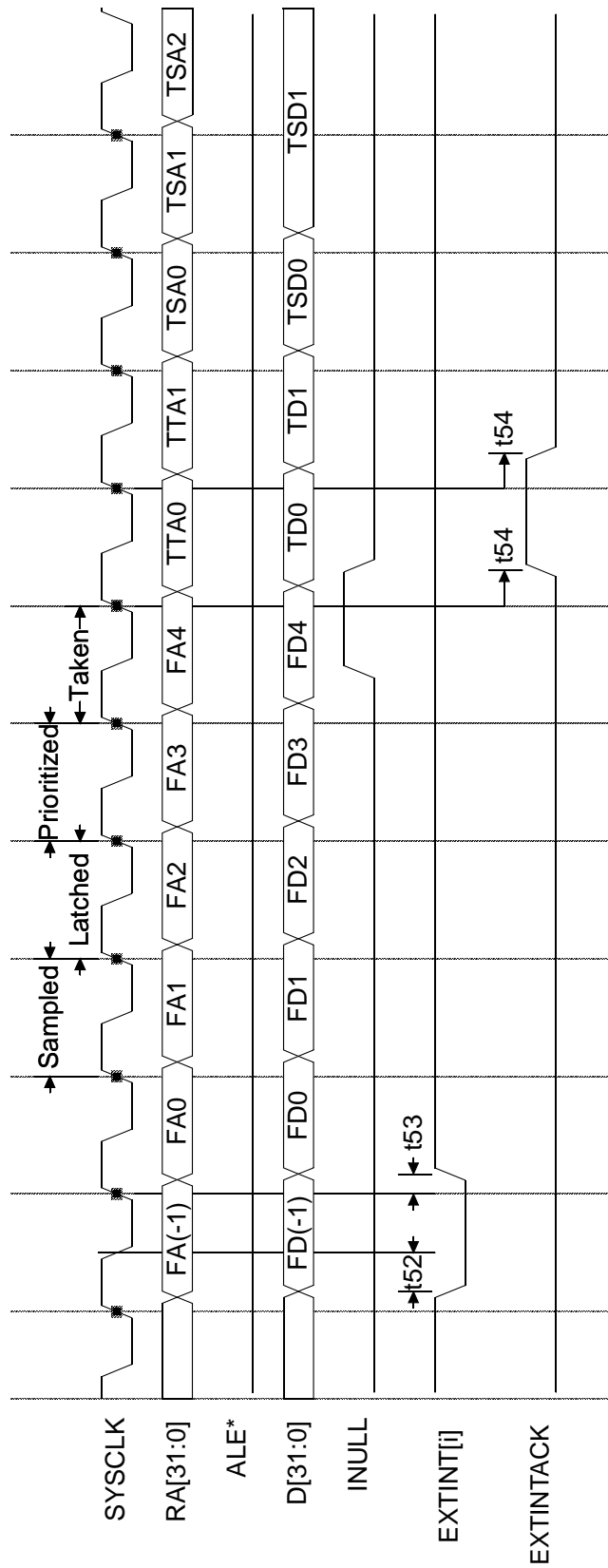

Figure 20. Halt Timing

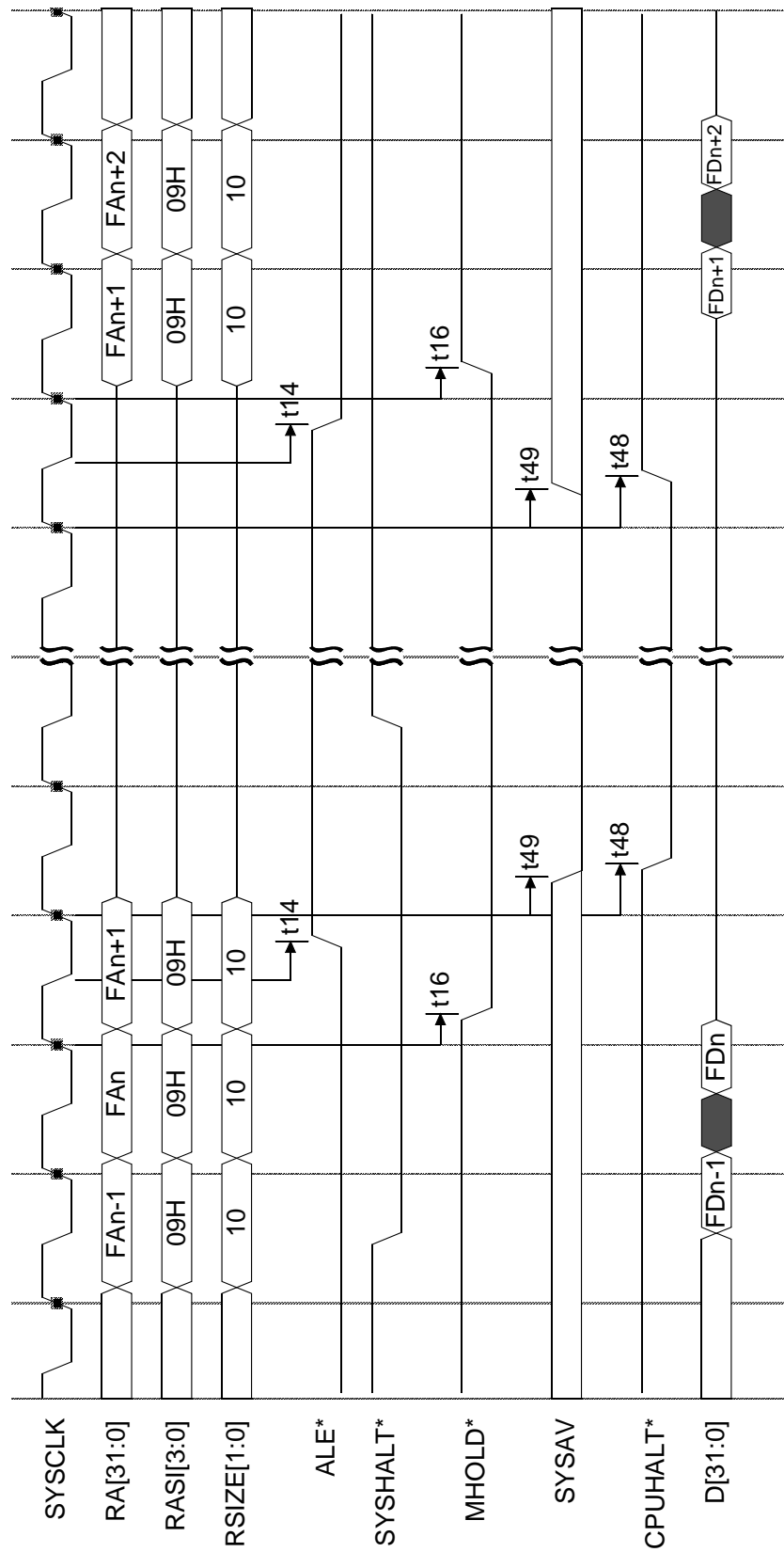

Figure 21. External Error with Halt Timing

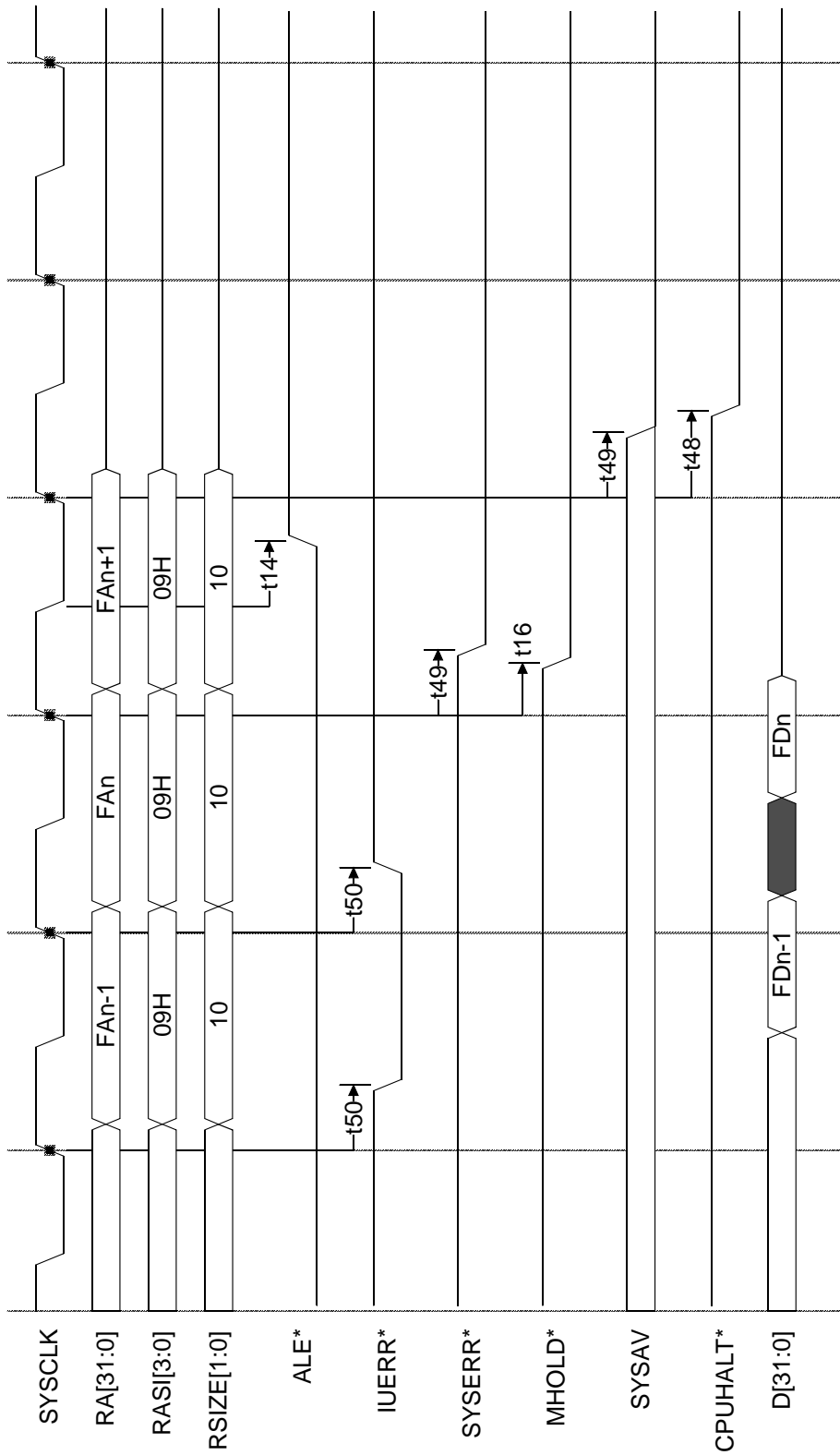

Figure 22. Reset Timing

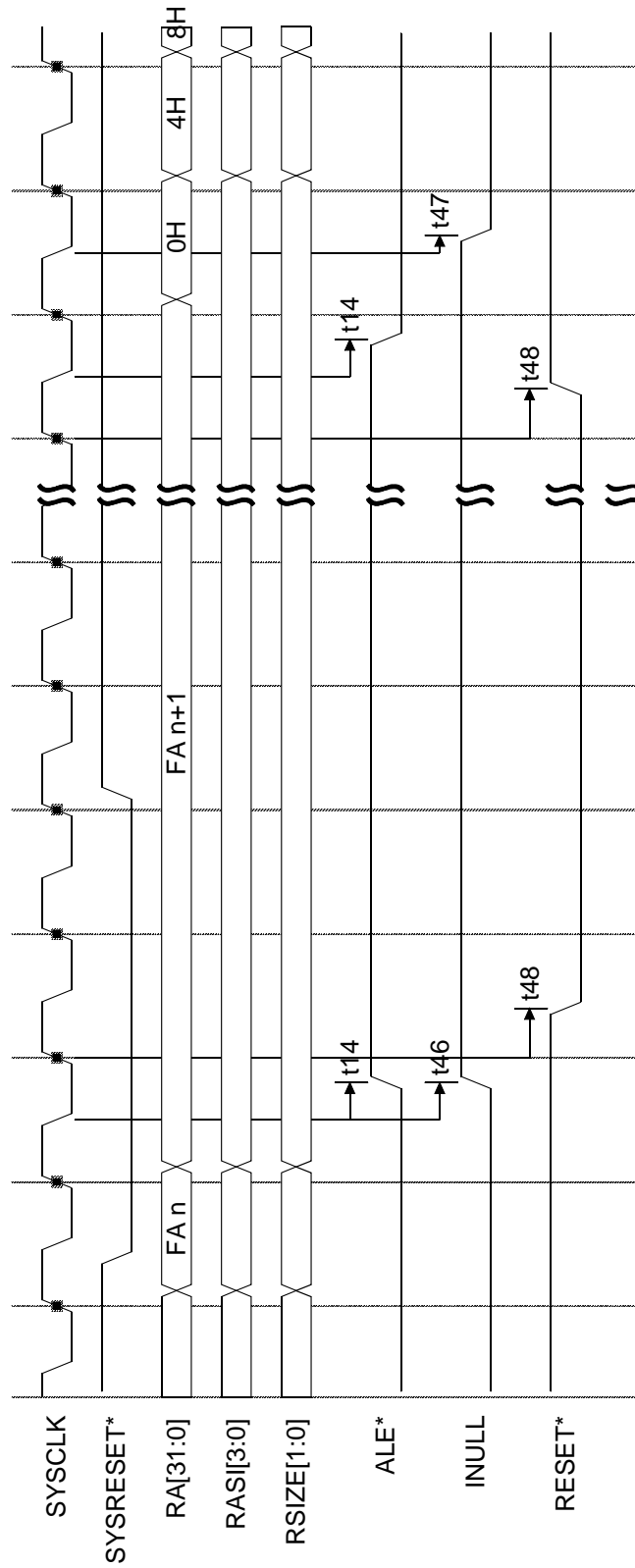
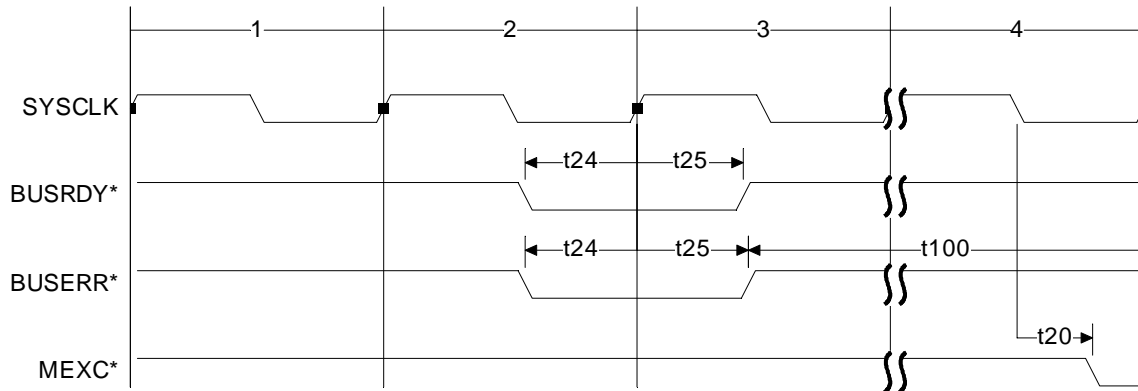
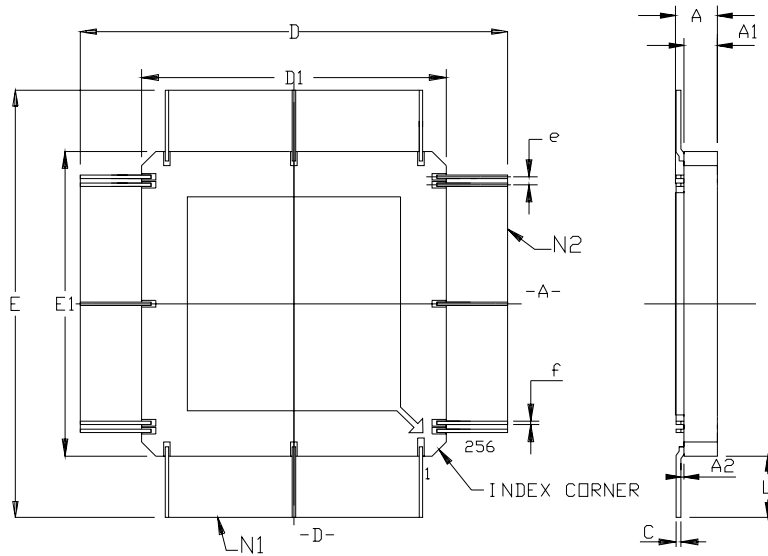

Figure 23. External Error signaling with BUSERR* and BUSRDY*



Package Drawings

256-lead MQFP-F



	mm		mil s	
	Min	Max	Min	Max
A	2.41	3.18	.095	.125
C	0.10	0.20	.004	.008
D	53.23	55.74	2.095	2.195
D1	36.83	37.34	1.450	1.470
E	53.23	55.74	2.095	2.195
E1	36.83	37.34	1.450	1.470
e	0.508 BSC		.020 BSC	
f	0.15	0.25	.006	.010
A1	2.06	2.56	.081	.101
A2	0.05	0.36	.002	.014
L	8.20	9.20	.323	.362
N1	64		64	
N2	64		64	



256-lead MQFP-F Pin Assignments

Table 7. Pin Assignments

Pin	Signal	Pin	Signal	Pin	Signal	Pin	Signal
1	GPIINT	65	D[0]	129	RA[0]	193	DXFER
2	GPI[7]	66	RSIZE[1]	130	VCCO	194	$\overline{\text{MEXC}}$
3	VCCO	67	RSIZE[0]	131	VSSO	195	VCCO
4	VSSO	68	RASI[3]	132	RAPAR	196	VSSO
5	GPI[6]	69	VCCO	133	RASPAR	197	$\overline{\text{RESET}}$
6	GPI[5]	70	VSSO	134	DPAR	198	$\overline{\text{SYSRESET}}$
7	GPI[4]	71	RASI[2]	135	VCCO	199	BA[1]
8	GPI[3]	72	RASI[1]	136	VSSO	200	BA[0]
9	VCCO	73	RASI[0]	137	SYSCLK	201	CB[6]
10	VSSO	74	RA[31]	138	TDO	202	CB[5]
11	GPI[2]	75	RA[30]	139	$\overline{\text{TRST}}$	203	VCCO
12	GPI[1]	76	VCCO	140	TMS	204	VSSO
13	GPI[0]	77	VSSO	141	TDI	205	CB[4]
14	D[31]	78	RA[29]	142	TCK	206	CB[3]
15	D[30]	79	RA[28]	143	CLK2	207	CB[2]
16	VCCO	80	RA[27]	144	$\overline{\text{DRDY}}$	208	CB[1]
17	VSSO	81	VCCO	145	DMAAS	209	VCCO
18	D[29]	82	VSSO	146	VCCO	210	VSSO
19	D[28]	83	RA[26]	147	VSSO	211	CB[0]
20	VCCI	84	RA[25]	148	$\overline{\text{DMAGNT}}$	212	$\overline{\text{ALE}}$
21	VSSI	85	RA[24]	149	$\overline{\text{EXMCS}}$	213	VCCI
22	D[27]	86	VCCI	150	VCCI	214	VSSI
23	D[26]	87	VSSI	151	VSSI	215	$\overline{\text{PROM8}}$
24	VCCO	88	VCCO	152	$\overline{\text{DMAREQ}}$	216	$\overline{\text{ROMCS}}$
25	VSSO	89	VSSO	153	$\overline{\text{BUSERR}}$	217	$\overline{\text{MEMCS[9]}}$
26	D[25]	90	RA[23]	154	$\overline{\text{BUSRDY}}$	218	VCCO
27	D[24]	91	RA[22]	155	$\overline{\text{ROMWRT}}$	219	VSSO
28	D[23]	92	RA[21]	156	$\overline{\text{NOPAR}}$	220	$\overline{\text{MEMCS[8]}}$
29	D[22]	93	VCCO	157	$\overline{\text{SYSHALT}}$	221	$\overline{\text{MEMCS[7]}}$
30	VCCO	94	VSSO	158	$\overline{\text{CPUHALT}}$	222	$\overline{\text{MEMCS[6]}}$
31	VSSO	95	RA[20]	159	VCCO	223	$\overline{\text{MEMCS[5]}}$
32	D[21]	96	RA[19]	160	VSSO	224	$\overline{\text{MEMCS[4]}}$
33	D[20]	97	RA[18]	161	SYSERR	225	$\overline{\text{MEMCS[3]}}$

Table 7. Pin Assignments (Continued)

Pin	Signal	Pin	Signal	Pin	Signal	Pin	Signal
34	D[19]	98	VCCO	162	SYSAV	226	VCCO
35	D[18]	99	VSSO	163	EXTINT[4]	227	VSSO
36	VCCO	100	RA[17]	164	EXTINT[3]	228	$\overline{\text{MEMCS}}[2]$
37	VSSO	101	RA[16]	165	EXTINT[2]	229	$\overline{\text{MEMCS}}[1]$
38	D[17]	102	RA[15]	166	EXTINT[1]	230	$\overline{\text{MEMCS}}[0]$
39	D[16]	103	VCCO	167	EXTINT[0]	231	VCCI
40	VCCI	104	VSSO	168	VCCI	232	VSSI
41	VSSI	105	RA[14]	169	VSSI	233	$\overline{\text{OE}}$
42	D[15]	106	VCCI	170	EXTINTACK	234	VCCO
43	D[14]	107	VSSI	171	$\overline{\text{IUERR}}$	235	VSSO
44	VCCO	108	RA[13]	172	VCCO	236	$\overline{\text{MEMWR}}$
45	VSSO	109	RA[12]	173	VSSO	237	$\overline{\text{BUFFEN}}$
46	D[13]	110	VCCO	174	CPAR	238	DDIR
47	D[12]	111	VSSO	175	TXA	239	VCCO
48	D[11]	112	RA[11]	176	RXA	240	VSSO
49	D[10]	113	RA[10]	177	RXB	241	$\overline{\text{DDIR}}$
50	VCCO	114	RA[9]	178	TXB	242	$\overline{\text{MHOLD}}$
51	VSSO	115	VCCO	179	$\overline{\text{IOWR}}$	243	$\overline{\text{MDS}}$
52	D[9]	116	VSSO	180	$\overline{\text{IOSEL}}[3]$	244	WDCLK
53	D[8]	117	RA[8]	181	VCCO	245	IWDE
54	D[7]	118	RA[7]	182	VSSO	246	EWDINT
55	D[6]	119	RA[6]	183	$\overline{\text{IOSEL}}[2]$	247	TMODE[1]
56	VCCO	120	VCCO	184	$\overline{\text{IOSEL}}[1]$	248	TMODE[0]
57	VSSO	121	VSSO	185	$\overline{\text{IOSEL}}[0]$	249	DEBUG
58	D[5]	122	RA[5]	186	WRT	250	INULL
59	D[4]	123	RA[4]	187	$\overline{\text{WE}}$	251	DIA
60	D[3]	124	RA[3]	188	VCCO	252	VCCO
61	D[2]	125	VCCO	189	VSSO	253	VSSO
62	VCCO	126	VSSO	190	RD	254	FLUSH
63	VSSO	127	RA[2]	191	RLDSTO	255	INST
64	D[1]	128	RA[1]	192	LOCK	256	RTC



Ordering Information

Table 8. Possible Order Entries

Part Number	Supply Voltage	Operating Temperature (°C)	Max Speed	Packaging	Quality Flow
TSC695FL-15MA-E	3.3V	25	15	MQFP-F256	Engineering Samples
TSC695FL-15MA	3.3V	-55 to 125	15	MQFP-F256	Standard Mil.
5962-0324601QXC	3.3V	-55 to 125	15	MQFP-F256	QML Q
5962-0324601VXC	3.3V	-55 to 125	15	MQFP-F256	QML V
TSC695FL-15SASB	3.3V	-55 to 125	15	MQFP-F256	ESCC
TSC695FL-15MB-E	3.3V	25	15	Die	Engineering Samples
5962-0324601Q9A	3.3V	-55 to 125	15	Die	QML Q
5962-0324601V9A	3.3V	-55 to 125	15	Die	QML V



Atmel Corporation

2325 Orchard Parkway
San Jose, CA 95131, USA
Tel: 1(408) 441-0311
Fax: 1(408) 487-2600

Regional Headquarters

Europe

Atmel Sarl
Route des Arsenaux 41
Case Postale 80
CH-1705 Fribourg
Switzerland
Tel: (41) 26-426-5555
Fax: (41) 26-426-5500

Asia

Room 1219
Chinachem Golden Plaza
77 Mody Road Tsimshatsui
East Kowloon
Hong Kong
Tel: (852) 2721-9778
Fax: (852) 2722-1369

Japan

9F, Tonetsu Shinkawa Bldg.
1-24-8 Shinkawa
Chuo-ku, Tokyo 104-0033
Japan
Tel: (81) 3-3523-3551
Fax: (81) 3-3523-7581

Atmel Operations

Memory

2325 Orchard Parkway
San Jose, CA 95131, USA
Tel: 1(408) 441-0311
Fax: 1(408) 436-4314

Microcontrollers

2325 Orchard Parkway
San Jose, CA 95131, USA
Tel: 1(408) 441-0311
Fax: 1(408) 436-4314

La Chantrerie
BP 70602
44306 Nantes Cedex 3, France
Tel: (33) 2-40-18-18-18
Fax: (33) 2-40-18-19-60

ASIC/ASSP/Smart Cards

Zone Industrielle
13106 Rousset Cedex, France
Tel: (33) 4-42-53-60-00
Fax: (33) 4-42-53-60-01

1150 East Cheyenne Mtn. Blvd.
Colorado Springs, CO 80906, USA
Tel: 1(719) 576-3300
Fax: 1(719) 540-1759

Scottish Enterprise Technology Park
Maxwell Building
East Kilbride G75 0QR, Scotland
Tel: (44) 1355-803-000
Fax: (44) 1355-242-743

RF/Automotive

Theresienstrasse 2
Postfach 3535
74025 Heilbronn, Germany
Tel: (49) 71-31-67-0
Fax: (49) 71-31-67-2340

1150 East Cheyenne Mtn. Blvd.
Colorado Springs, CO 80906, USA
Tel: 1(719) 576-3300
Fax: 1(719) 540-1759

Biometrics/Imaging/Hi-Rel MPU/ High Speed Converters/RF Datacom

Avenue de Rochepleine
BP 123
38521 Saint-Egreve Cedex, France
Tel: (33) 4-76-58-30-00
Fax: (33) 4-76-58-34-80

Literature Requests

www.atmel.com/literature

Disclaimer: The information in this document is provided in connection with Atmel products. No license, express or implied, by estoppel or otherwise, to any intellectual property right is granted by this document or in connection with the sale of Atmel products. **EXCEPT AS SET FORTH IN ATMEL'S TERMS AND CONDITIONS OF SALE LOCATED ON ATMEL'S WEB SITE, ATMEL ASSUMES NO LIABILITY WHATSOEVER AND DISCLAIMS ANY EXPRESS, IMPLIED OR STATUTORY WARRANTY RELATING TO ITS PRODUCTS INCLUDING, BUT NOT LIMITED TO, THE IMPLIED WARRANTY OF MERCHANTABILITY, FITNESS FOR A PARTICULAR PURPOSE, OR NON-INFRINGEMENT. IN NO EVENT SHALL ATMEL BE LIABLE FOR ANY DIRECT, INDIRECT, CONSEQUENTIAL, PUNITIVE, SPECIAL OR INCIDENTAL DAMAGES (INCLUDING, WITHOUT LIMITATION, DAMAGES FOR LOSS OF PROFITS, BUSINESS INTERRUPTION, OR LOSS OF INFORMATION) ARISING OUT OF THE USE OR INABILITY TO USE THIS DOCUMENT, EVEN IF ATMEL HAS BEEN ADVISED OF THE POSSIBILITY OF SUCH DAMAGES.** Atmel makes no representations or warranties with respect to the accuracy or completeness of the contents of this document and reserves the right to make changes to specifications and product descriptions at any time without notice. Atmel does not make any commitment to update the information contained herein. Atmel's products are not intended, authorized, or warranted for use as components in applications intended to support or sustain life.

© Atmel Corporation 2005. All rights reserved. Atmel®, logo and combinations thereof, are registered trademarks, and Everywhere You Are® are the trademarks of Atmel Corporation or its subsidiaries. Other terms and product names may be trademarks of others.



Printed on recycled paper.