

# SPECIFICATION FOR APPROVAL

REF : 20080801-A

PAGE: 1

PROD. NAME	SHIELDED SMD POWER INDUCTOR	ABC'S DWG NO. ABC'S ITEM NO.	SH3016□□□□L□-□□□
---------------	--------------------------------	---------------------------------	------------------

## I . CONFIGURATION & DIMENSIONS :

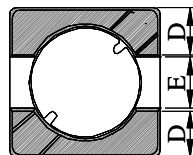
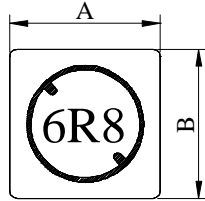

- A : 3.80±0.30 m/m
- B : 3.80±0.30 m/m
- C : 1.55±0.15 m/m
- D : 1.30 typ. m/m
- E : 1.20 typ. m/m
- G : 1.10 ref. m/m
- H : 4.30 ref. m/m
- I : 1.60 ref. m/m
- R : 1.30 ref. m/m

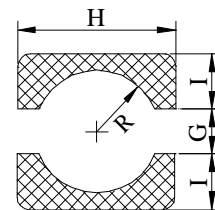

( PCB Pattern suggestion )

## II . SCHEMATIC DIAGRAM :

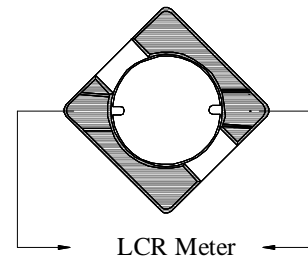
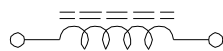

## III . MATERIALS :

- a . Core : Ferrite DR core
- b . Core : Ferrite RI core
- c . Wire : Enamelled copper wire (Class F & H)
- d . Adhesive : Epoxy resin
- e . Terminal : Ag/Ni/Sn
- f . Remark : Products comply with RoHS' requirements

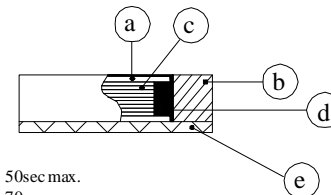

Peak Temp : 260°C max.  
 Max time above 230°C : 50sec max.  
 Max time above 200°C : 70sec max.

## IV . GENERAL SPECIFICATION :

- a . Temp. rise : 30°C max.
- b . Storage temp. : -40°C ----+125°C
- c . Operating temp. : -40°C ----+105°C
- d . Resistance to solder heat : 260°C .10 secs.

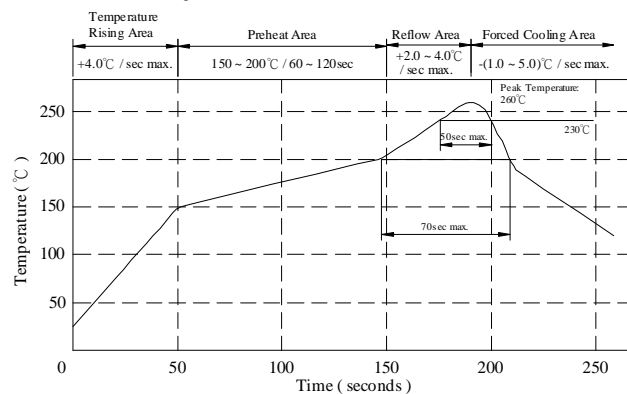

AR-001A

# SPECIFICATION FOR APPROVAL

REF : 20080801-A

PAGE: 2

PROD. NAME	SHIELDED SMD POWER INDUCTOR	ABC'S DWG NO.	SH3016□□□□L□-□□□
		ABC'S ITEM NO.	

**V . ELECTRICAL CHARACTERISTICS :**

DWG No.	Inductance ( $\mu$ H)	RDC (m $\Omega$ ) max.	IDC (mA) typ.
SH30161R5YL□-□□□	1.5 $\pm$ 30%	45.0	1450.0
SH30162R5YL□-□□□	2.5 $\pm$ 30%	65.0	1150.0
SH30163R6YL□-□□□	3.6 $\pm$ 30%	90.0	900.0
SH30164R7YL□-□□□	4.7 $\pm$ 30%	120.0	800.0
SH30166R8YL□-□□□	6.8 $\pm$ 30%	170.0	660.0
SH3016100YL□-□□□	10.0 $\pm$ 30%	240.0	520.0
SH3016150YL□-□□□	15.0 $\pm$ 30%	340.0	430.0
SH3016220YL□-□□□	22.0 $\pm$ 30%	510.0	360.0
SH3016330YL□-□□□	33.0 $\pm$ 30%	780.0	290.0
SH3016470YL□-□□□	47.0 $\pm$ 30%	1200.0	230.0
SH3016680YL□-□□□	68.0 $\pm$ 30%	1800.0	200.0
SH3016101YL□-□□□	100.0 $\pm$ 30%	2400.0	160.0

- 1). □: Packaging information... [A]: Bulk [B]: Taping Reel
- 2). "-□□□": Reference code
- 3). Inductance Test Freq. : 100KHz /0.1V
- 4). IDC Base on Tenp. rese 30°C max. &  $\Delta$ L/L0A=35% typ.

AR-001A



# SPECIFICATION FOR APPROVAL

REF : 20080801-A

PAGE: 3

PROD. NAME	SHIELDED SMD POWER INDUCTOR	ABC'S DWG NO.	SH3016□□□□L□-□□□
		ABC'S ITEM NO.	

## VI . PACKAGING INFORMATION :

### ( 1 ) Configuration

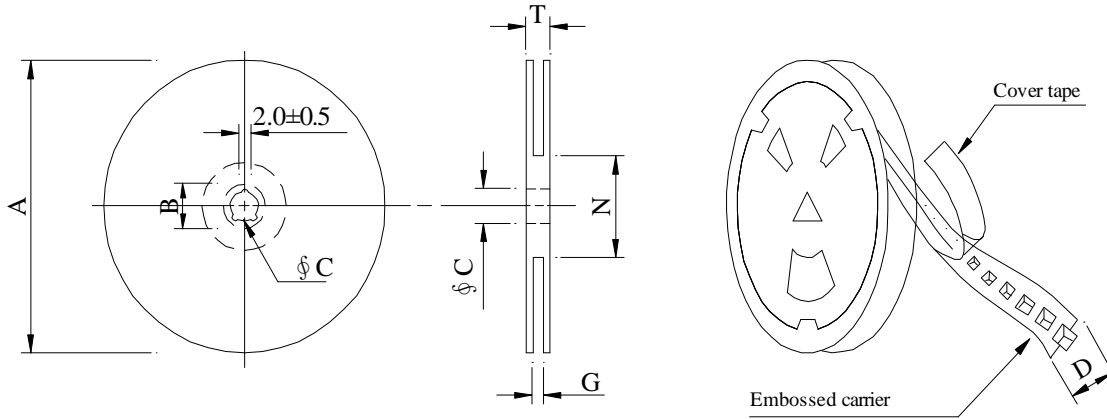

※Carrier tape width : D

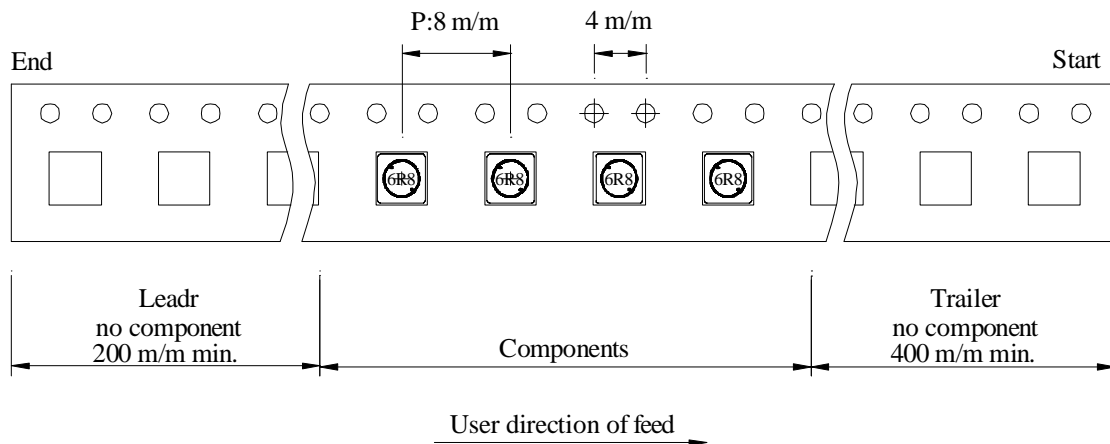

### ( 2 ) Dimensions

Unit:m/m

Style	A	B	C	D	G	N	T
07 - 12	178	21±0.8	13	12	14 <sup>+0</sup>	50 <sup>-0</sup>	16.5

### ( 3 ) Q'TY & G.W. Per package

Series	Inner : Reel			Outer : Carton		
	Q'TY (pcs)	G.W. (gw)	Style	Q'TY (pcs)	G.W. (Kg)	Size (cm)
SH3016	1,000	150	07 - 12	40,000	8.50	42 x 41 x 24

AR-001A

# SPECIFICATION FOR APPROVAL

REF : 20080801-A

PAGE: 4

PROD. NAME	SHIELDED SMD POWER INDUCTOR	ABC'S DWG NO.	SH3016□□□□L□-□□□
		ABC'S ITEM NO.	

**VII . DWGING NUMBER EXPRESSION :**

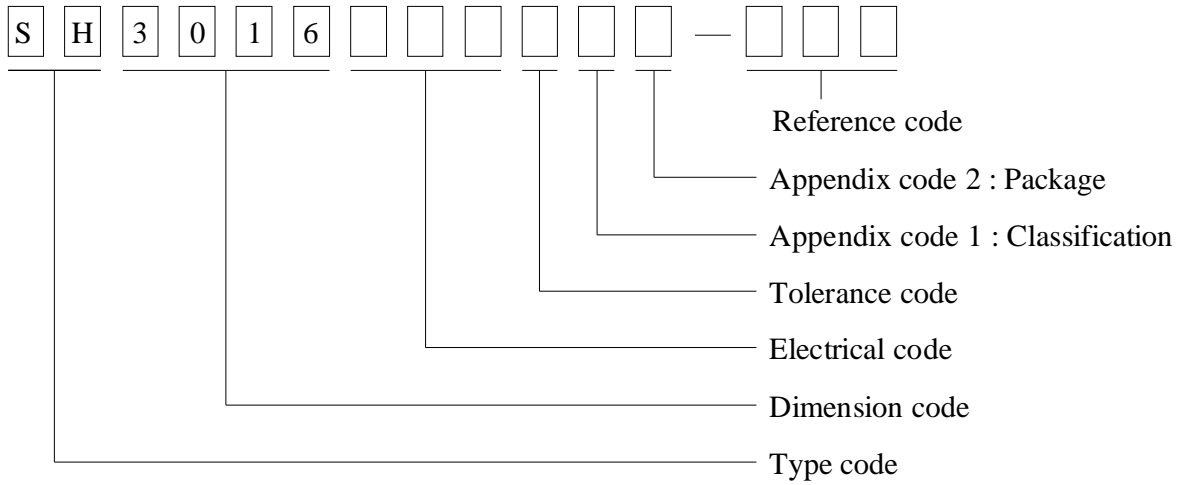

**Appendix code 1 : Product Classification**

- L : Lead Free Standard products comply with RoHS' requirements
- 1 ~ 9 : Lead Free Special products comply with RoHS' requirements

**Appendix code 2 : Package Information**

Code	Inner package	Inner package QTY	Remark
A	T.B.D.	T.B.D.	
B	T / R ( Reel package )	1,000 pcs	

# SPECIFICATION FOR APPROVAL

REF : 20080801-A

PAGE: 5

PROD. NAME	SHIELDED SMD POWER INDUCTOR	ABC'S DWG NO. ABC'S ITEM NO.	SH3016□□□□L□-□□□
---------------	--------------------------------	---------------------------------	------------------

**VIII . RELIABILITY TEST :**

Test item	Specification	Test condition						
Solderability	More than 95% of the terminal electrode shall be covered With fresh solder.	Preheat : 155°C / 4 hours. Solder : Sn96.5 / Ag3 / Cu0.5 or equivalent Solder temp. : 235±5°C Flux : Rosin Dip time : 5±0.5 seconds						
Thermal shock test ( Temp. cycle )	Electrical oharacteristics shall not change more than ±20%	<table style="width: 100%; border: none;"> <tr> <td style="text-align: center;">Room temp. 15 minutes</td> <td style="text-align: center;">→</td> <td style="text-align: center;">-40 °C 30 minutes</td> </tr> <tr> <td style="text-align: center;">Room temp. 15 minutes</td> <td style="text-align: center;">→</td> <td style="text-align: center;">+105 °C 30 minutes</td> </tr> </table> <p>Total : 50 cycles</p>	Room temp. 15 minutes	→	-40 °C 30 minutes	Room temp. 15 minutes	→	+105 °C 30 minutes
Room temp. 15 minutes		→	-40 °C 30 minutes					
Room temp. 15 minutes		→	+105 °C 30 minutes					
Humidity test		Temperature : 40±2°C Humidity : 90±5% Time : 1000 hours						
High temp. Resistance test	Temperature : 105±5°C Applied current : Per spec. Time : 96 hours							

AR-001A



# SPECIFICATION FOR APPROVAL

PROD. NAME	SHIELDED SMD POWER INDUCTOR	ABC'S DWG NO.	SH3016□□□□L□-□□□
		ABC'S ITEM NO.	

**IX . UL CARD :**

**OBMW2**

Magnet Wire-Component

**JUNG SHING WIRE CO LTD**  
231 CHUNG CHENG RD, SEC 3 JEN-TEH HSIANG, TAINAN  
HSIEN TAIWAN

September 8, 2000

E174837

Mtl Dsg	Mark Dsg	BC	Coat Typ	OC	ANSI Type	Temp Class
AIW	—	Polyamideimide	—	—	MW81-C	220
CFUEWB	—	Polyurethane	—	—	MW75C	130
EIAIW	—	Polyesterimide	Polyamideimide	—	MW35C	200
EILOCKY	—	Polyesterimide	Polyamide	—	—	180
EILOCKW	—	Polyesterimide	Modified Epoxy	—	—	200
EIW	—	Polyesterimide	—	—	—	220
EIW-2	—	Polyesterimide	—	—	MW74-C	200
FL.EILOCKY	—	Modified Polyester	Polyamide	—	—	155
LSFFW	—	Polyurethane	—	—	MW79-C	155
LSUEW	—	Polyurethane	—	—	—	130
PEW	—	Polyester	—	—	—	155
PEY	—	Polyester	Nylon	—	MW24-C	155
SF.FLW	—	Modified Polyester	—	—	MW26C	155
SF.EIW	—	Polyesterimide	—	—	MW77C	180
SF.BY@	—	Modified Polyester	Nylon	—	MW27-C	155
SF.FLY@	—	Modified Polyester	Nylon	—	MW27-C	155
SF.BLOCKBS	—	Modified Polyester	Modified Polyamide	—	—	155
SF.EILOCKY#	—	Polyesterimide	Polyamide	—	—	180
SF.EILOCKBS	—	Polyesterimide	Modified Polyamide	—	—	180
SF.BW@	—	Modified Polyester	—	—	MW26C	155
SFFW	—	Polyurethane	—	—	MW79	155

287806002
Page 1 of 2
A not-for-profit organization dedicated to public safety and committed to quality service

Mtl Dsg	Mark Dsg	BC	Coat Typ	OC	ANSI Type	Temp Class
SFFY	—	Polyurethane	Polyamide	—	MW80C	155
UEW-1	—	Polyurethane	—	—	MW2-C	105
UEW-2	—	Polyurethane	—	—	—	130
UEW-4	—	Polyurethane	—	—	MW75C	130
UEY	—	Polyurethane	Nylon	—	MW28-C	130
UEY-2	—	Polyurethane	Polyamide	—	MW28-C	130

@-May be suffixed by LZ; # - May be suffixed by LZ, EL or LZL.  
 LZ - Signifies magened wires twisted together; EL - signifies base coated magnet wire laid parallel with top coat applied overall; LZL - signifies base coated magnet wire twisted together and covered with top coat overall.  
 Marking: Company name or trademarks **JSW** or 榮星電線 , material designation or marked designation on packaed or reel, and Recognized Component Mark.

---

See General Information Preceding These Recognitions  
 For use only in equipment where the acceptability of the combination is determined by Underwriters Laboratories Inc.

287806002
Page 2 of 2
OBMW2/E174837  
September 8, 2000

# SPECIFICATION FOR APPROVAL

REF : 20080801-A

PAGE: 7

PROD. NAME	SHIELDED SMD POWER INDUCTOR	ABC'S DWG NO. ABC'S ITEM NO.	SH3016□□□□L□-□□□
---------------	--------------------------------	---------------------------------	------------------

OBMW2 October 06, 2005

Magnet Wire-Component

ELEKTRISOLA (MALAYSIA) SDN BHD E143312

JALAN DAMAI SATU JANDA BAIK 28750 BENTONG, PAHANG  
DARUL MAKMUR MALAYSIA

Mtl Dsg	Mark Dsg	Coating Type		ANSI Typ	Temp Class
		BC	OC		
Estersol 180	E180	Polyesterimide (solderable)	---	MW-77	180
Amldester 200	A200	Polyesterimide	---	MW-74	200
Polysol-N 155	PN155	Polyurethane	Nylon	MW-80, MW-28	155, 130
Polysol 155	P155, G155	Polyurethane	---	MW-79, MW-75	155, 130
Polysol 155g	Pg155	Polyurethane	---	MW-75	130
Polysol 155p	Pp155, Gp155	Polyurethane	---	MW-79	155
Polysol 160	P160	Polyurethane	---	MW-79	155
Polysol 180	P180, G180	Polyurethane	---	MW-82, MW-79	180, 155
Polysol 170	P170 or G170	Polyurethane	---	MW-79	155
Polysol-N 180	PN180	Polyurethane	Nylon	MW-83	180
Polysol P155p	P155p	Polyurethane	---	MW-79	155

Marking : Company name, material designation or marked designation and factory identification on package ok reel

---

See General Information preceding These Recognitions

For use only in equipment where the acceptability of the combination is determined by Underwriters Laboratories Inc.

AR-001A

