

MBRF2060CT

SWITCHMODE™ Schottky Power Rectifier

The SWITCHMODE Power Rectifier employs the Schottky Barrier principle in a large area metal-to-silicon power diode. State-of-the-art geometry features epitaxial construction with oxide passivation and metal overlay contact. Ideally suited for use as rectifiers in very low-voltage, high-frequency switching power supplies, free wheeling diodes and polarity protection diodes.

Features

- Highly Stable Oxide Passivated Junction
- Very Low Forward Voltage Drop
- Matched Dual Die Construction
- High Junction Temperature Capability
- High dv/dt Capability
- Excellent Ability to Withstand Reverse Avalanche Energy Transients
- Guardring for Stress Protection
- Epoxy Meets UL 94 V-0 @ 0.125 in
- Electrically Isolated. No Isolation Hardware Required.
- Pb-Free Package is Available*

Mechanical Characteristics:

- Case: Epoxy, Molded
- Weight: 1.9 Grams (Approximately)
- Finish: All External Surfaces Corrosion Resistant and Terminal Leads are Readily Solderable
- Lead Temperature for Soldering Purposes:
260°C Max. for 10 Seconds



ON Semiconductor®

<http://onsemi.com>

**SCHOTTKY BARRIER
RECTIFIER
20 AMPERES, 60 VOLTS**

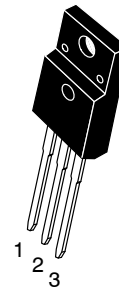
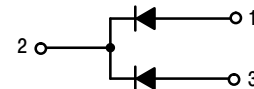

**ISOLATED TO-220
CASE 221D
STYLE 3**

MARKING DIAGRAM

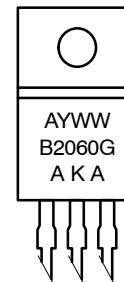

A = Assembly Location
Y = Year
WW = Work Week
B2060 = Device Code
G = Pb-Free Package
AKA = Polarity Designator

ORDERING INFORMATION

| Device | Package | Shipping |
|-------------|-----------------------|---------------|
| MBRF2060CT | TO-220FP | 50 Units/Rail |
| MBRF2060CTG | TO-220FP (Pb-Free) | 50 Units/Rail |

*For additional information on our Pb-Free strategy and soldering details, please download the ON Semiconductor Soldering and Mounting Techniques Reference Manual, SOLDERRM/D.

MBRF2060CT

MAXIMUM RATINGS (Per Leg)

| Rating | Symbol | Value | Unit |
|--|---------------------------------|--------------|------------------|
| Peak Repetitive Reverse Voltage Working Peak Reverse Voltage DC Blocking Voltage | V_{RRM} V_{RWM} V_R | 60 | V |
| Average Rectified Forward Current (Rated V_R), $T_C = 133^\circ\text{C}$ | $I_{F(AV)}$ | 10 20 | A |
| Peak Repetitive Forward Current (Rated V_R , Square Wave, 20 kHz), $T_C = 133^\circ\text{C}$ | I_{FRM} | 20 | A |
| Nonrepetitive Peak Surge Current (Surge applied at rated load conditions halfwave, single phase, 60 Hz) | I_{FSM} | 150 | A |
| Peak Repetitive Reverse Surge Current (2.0 μs , 1.0 kHz) | I_{RRM} | 0.5 | A |
| Operating Junction and Storage Temperature Range (Note 1) | T_J, T_{stg} | - 65 to +175 | $^\circ\text{C}$ |
| Voltage Rate of Change (Rated V_R) | dv/dt | 10000 | V/ μs |
| RMS Isolation Voltage (t = 0.3 second, R.H. \leq 30%, $T_A = 25^\circ\text{C}$) (Note 2) | V_{iso1} | 4500 | V |

Stresses exceeding Maximum Ratings may damage the device. Maximum Ratings are stress ratings only. Functional operation above the Recommended Operating Conditions is not implied. Extended exposure to stresses above the Recommended Operating Conditions may affect device reliability.

THERMAL CHARACTERISTICS (Per Leg)

| Rating | Symbol | Value | Unit |
|---|-----------------|-------|---------------------------|
| Maximum Thermal Resistance, Junction-to-Case | $R_{\theta JC}$ | 4.0 | $^\circ\text{C}/\text{W}$ |
| Lead Temperature for Soldering Purposes: 1/8 in from Case for 5 Seconds | T_L | 260 | $^\circ\text{C}$ |

ELECTRICAL CHARACTERISTICS (Per Leg)

| Characteristic | Symbol | Max | Unit |
|--|--------|------------------------------|------|
| Maximum Instantaneous Forward Voltage (Note 3) ($i_F = 10$ Amp, $T_C = 25^\circ\text{C}$) ($i_F = 10$ Amp, $T_C = 125^\circ\text{C}$) ($i_F = 20$ Amp, $T_C = 25^\circ\text{C}$) ($i_F = 20$ Amp, $T_C = 125^\circ\text{C}$) | V_F | 0.85 0.75 0.95 0.85 | V |
| Maximum Instantaneous Reverse Current (Note 3) (Rated DC Voltage, $T_C = 25^\circ\text{C}$) (Rated DC Voltage, $T_C = 125^\circ\text{C}$) | i_R | 0.15 150 | mA |

- The heat generated must be less than the thermal conductivity from Junction-to-Ambient: $dP_D/dT_J < 1/R_{\theta JA}$.
- Proper strike and creepage distance must be provided.
- Pulse Test: Pulse Width = 300 μs , Duty Cycle \leq 2.0%

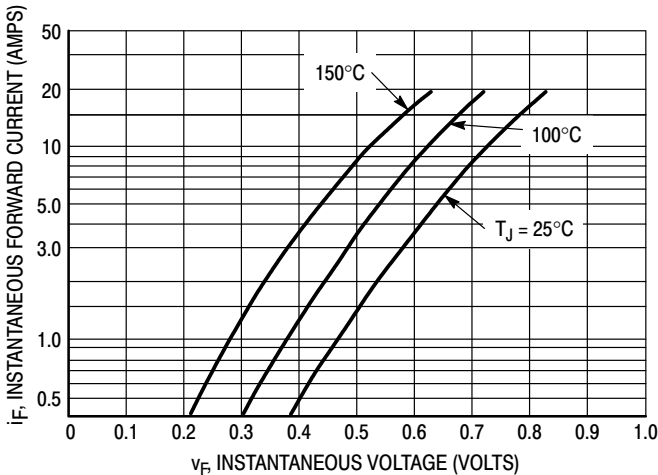

Figure 1. Typical Forward Voltage Per Diode

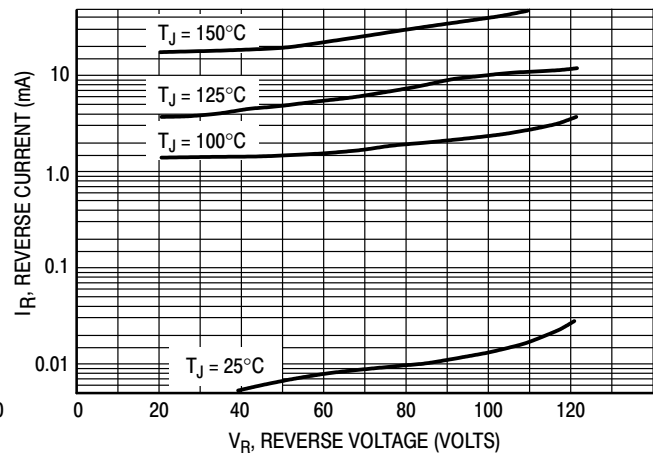

Figure 2. Typical Reverse Current Per Diode

MBRF2060CT

TEST CONDITION FOR ISOLATION TEST*

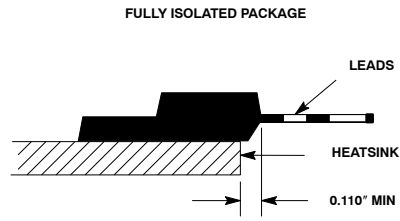
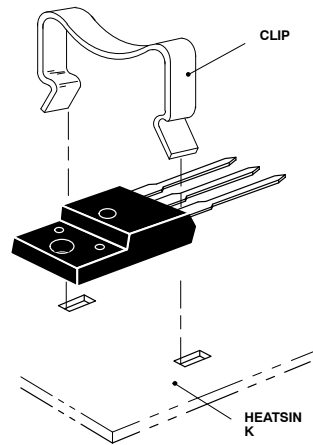

Figure 3. Mounting Position

*Measurement made between leads and heatsink with all leads shorted together.

MOUNTING INFORMATION



Clip-Mounted

Figure 4. Typical Mounting Technique

MBRF2060CT

PACKAGE DIMENSIONS

TO-220 FULLPAK
CASE 221D-03
ISSUE K

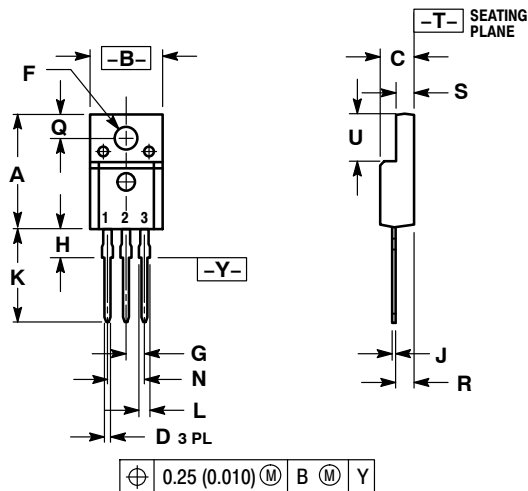

- NOTES:
1. DIMENSIONING AND TOLERANCING PER ANSI Y14.5M, 1982.
 2. CONTROLLING DIMENSION: INCH
 3. 221D-01 THRU 221D-02 OBSOLETE, NEW STANDARD 221D-03.

| DIM | INCHES | | MILLIMETERS | |
|-----|-----------|-------|-------------|-------|
| | MIN | MAX | MIN | MAX |
| A | 0.617 | 0.635 | 15.67 | 16.12 |
| B | 0.392 | 0.419 | 9.96 | 10.63 |
| C | 0.177 | 0.193 | 4.50 | 4.90 |
| D | 0.024 | 0.039 | 0.60 | 1.00 |
| F | 0.116 | 0.129 | 2.95 | 3.28 |
| G | 0.100 BSC | | 2.54 BSC | |
| H | 0.118 | 0.135 | 3.00 | 3.43 |
| J | 0.018 | 0.025 | 0.45 | 0.63 |
| K | 0.503 | 0.541 | 12.78 | 13.73 |
| L | 0.048 | 0.058 | 1.23 | 1.47 |
| N | 0.200 BSC | | 5.08 BSC | |
| Q | 0.122 | 0.138 | 3.10 | 3.50 |
| R | 0.099 | 0.117 | 2.51 | 2.96 |
| S | 0.092 | 0.113 | 2.34 | 2.87 |
| U | 0.239 | 0.271 | 6.06 | 6.88 |

STYLE 3:
PIN 1. ANODE
2. CATHODE
3. ANODE

SWITCHMODE is a trademark of Semiconductor Components Industries, LLC.

ON Semiconductor and  are registered trademarks of Semiconductor Components Industries, LLC (SCILLC). SCILLC reserves the right to make changes without further notice to any products herein. SCILLC makes no warranty, representation or guarantee regarding the suitability of its products for any particular purpose, nor does SCILLC assume any liability arising out of the application or use of any product or circuit, and specifically disclaims any and all liability, including without limitation special, consequential or incidental damages. "Typical" parameters which may be provided in SCILLC data sheets and/or specifications can and do vary in different applications and actual performance may vary over time. All operating parameters, including "Typicals" must be validated for each customer application by customer's technical experts. SCILLC does not convey any license under its patent rights nor the rights of others. SCILLC products are not designed, intended, or authorized for use as components in systems intended for surgical implant into the body, or other applications intended to support or sustain life, or for any other application in which the failure of the SCILLC product could create a situation where personal injury or death may occur. Should Buyer purchase or use SCILLC products for any such unintended or unauthorized application, Buyer shall indemnify and hold SCILLC and its officers, employees, subsidiaries, affiliates, and distributors harmless against all claims, costs, damages, and expenses, and reasonable attorney fees arising out of, directly or indirectly, any claim of personal injury or death associated with such unintended or unauthorized use, even if such claim alleges that SCILLC was negligent regarding the design or manufacture of the part. SCILLC is an Equal Opportunity/Affirmative Action Employer. This literature is subject to all applicable copyright laws and is not for resale in any manner.

PUBLICATION ORDERING INFORMATION

LITERATURE FULFILLMENT:
Literature Distribution Center for ON Semiconductor
P.O. Box 5163, Denver, Colorado 80217 USA
Phone: 303-675-2175 or 800-344-3860 Toll Free USA/Canada
Fax: 303-675-2176 or 800-344-3867 Toll Free USA/Canada
Email: orderlit@onsemi.com

N. American Technical Support: 800-282-9855 Toll Free
USA/Canada
Europe, Middle East and Africa Technical Support:
Phone: 421 33 790 2910
Japan Customer Focus Center
Phone: 81-3-5773-3850

ON Semiconductor Website: www.onsemi.com
Order Literature: <http://www.onsemi.com/orderlit>

For additional information, please contact your local Sales Representative