

TSR-105H

微 調 電 位 器

■ 單圈的/碳膜型/工業用/密封
 ■ (Single Turn/ Phenolic/ Industrial/ Sealed)

■ 6種引線的安裝尺寸
 ■ (6 Terminal Styles)



電氣特性 Electrical Characteristics	
標稱阻值範圍 Standard Resistance Range	10Ω - 2MΩ
阻值允許偏差 Resistance Tolerance	±10%, ±20%, ±30%
殘留阻值 Residual Resistance	不多於 10Ω 10Ω Maximum
綫性 Resistance Taper	對數/ Logarithm (A) 直綫/ Linear (B) 反對數/ Anti Logarithm (C)
功率 Rated Power	直綫型/ Linear (B), 0.15W 非直綫/ Non Linear (A,C), 0.07W
使用電壓 Operating Voltage	直綫型/ Linear (B), 250VDC 非直綫/ Non Linear (A,C), 125VDC
旋轉壽命 Pototional Life	(a) 500 次/ 500 Cycles (b) 長壽命: 10,000 次/ Long Life: 10,000 Cycles

機械性能 Mechanical Characteristics	
旋轉角度 Rotational Angle	235° ± 5°
扭力矩 Rotational Torque	20~200gf.cm
止擋力矩 Stop-end Strength	最小達 400g.cm 以上 400gf.cm minimum

氣候特性 Climatic Characteristics	
使用溫度 Operating Temp	-25°C ~ 40°C
溫度特性 Temp Characteristics	以 70°C 綫 5 小時, 阻值變化為 +5~ -10% +5~ -10% change in NR after 5 hours at 70°C
Humidity Char	在 40°C 溫度及相對濕度 95% 的情況下放置 500 小時, 阻值變化最大為 ±20% Maximum resistance change within ±20% after 500hours unloaded at 40°C and R.H.95%

焊接條件 Soldering Conditions	
焊接溫度 Temperature	260°C
焊接時間 Time	3 秒 3 seconds

TSR-105H

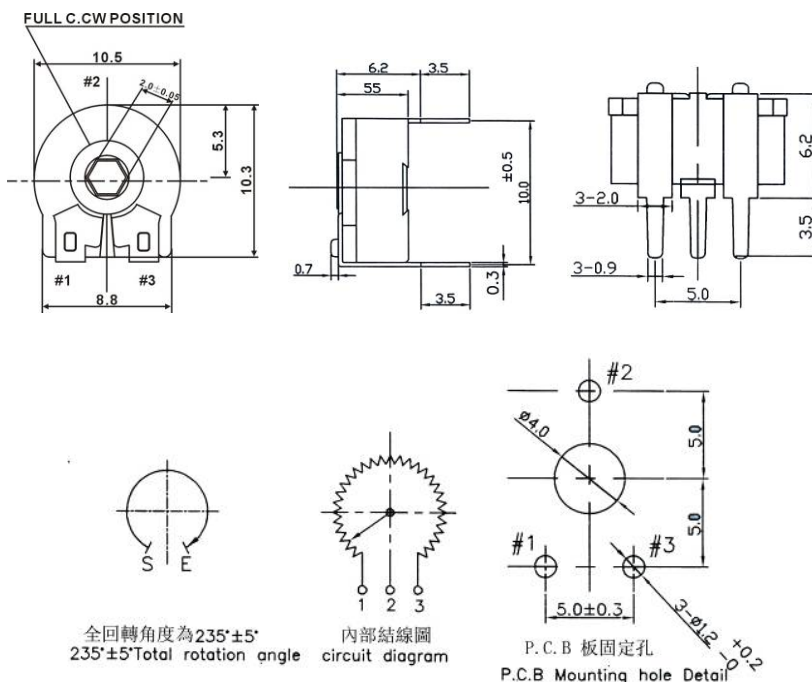

TSR-103H (5×2.5)

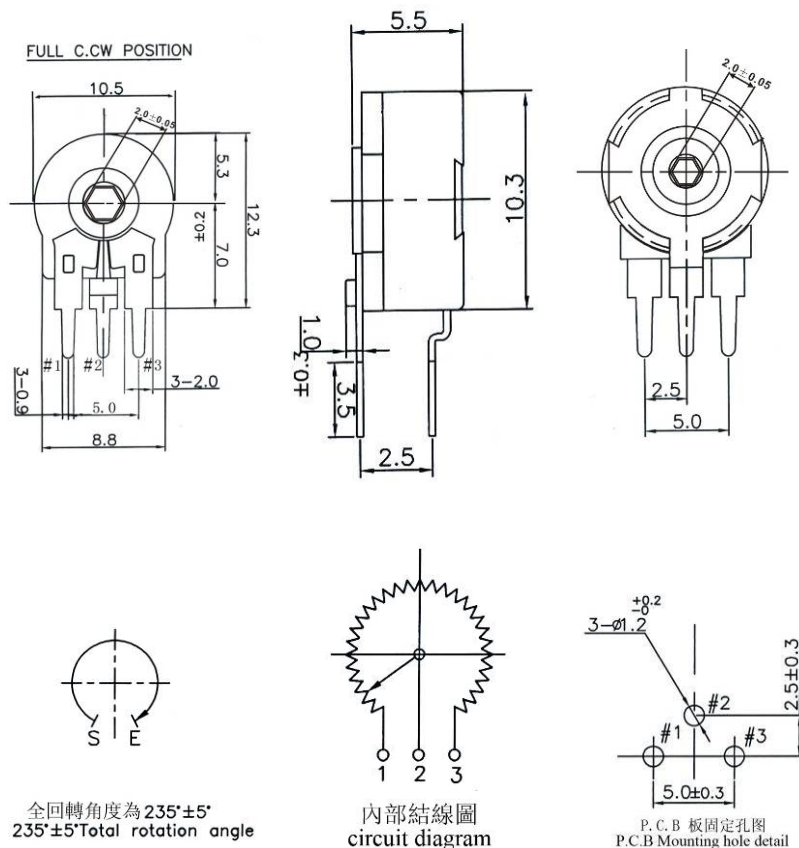

TSR-105H

共有尺寸 Common Dimensions
TSR-103H(5×5)

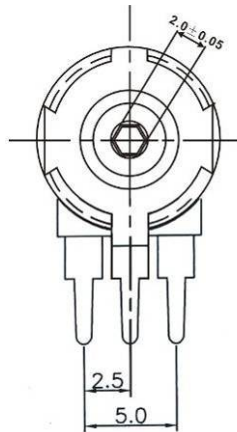
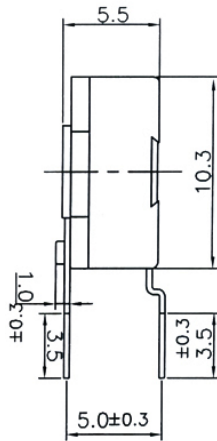
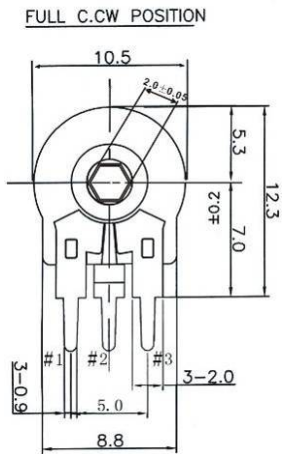

全回轉角度為 235°±5'
235°±5' Total rotation angle

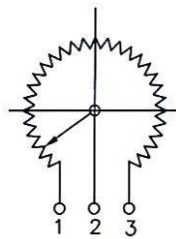

內部結線圖
circuit diagram

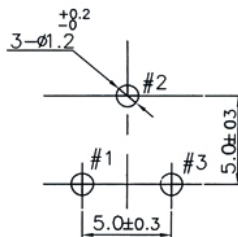

P. C. B 板固定孔圖
P.C.B Mounting hole detail

訂購指南 How to Order

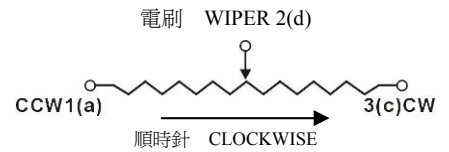
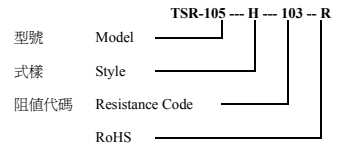

圖中公差：除注明外均為±0.25
Tolerance is ±0.25 if no identification

阻值代碼表

Standard Resistance table

Resistance(Ohms)	Resistance Code
10	100
20	200
50	500
100	101
200	201
500	501
1,000	102
2,000	202
5,000	502
10,000	103
20,000	203
25,000	253
50,000	503
100,000	104
200,000	204
250,000	254
500,000	504
1,000,000	105
2,000,000	205

可按用戶要求提供特殊規格

Special resistances available.

Rotors Type For without shaft

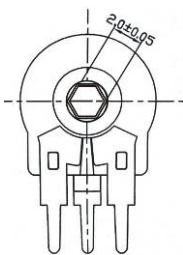

H=HEXAGONAL THRUHOLE
六角A

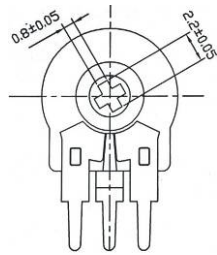

K=CROSS SLOT THRUHOLE
十字

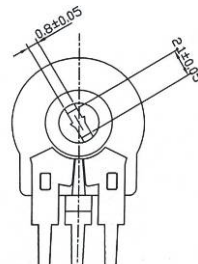

S=SCREW DRIVER THRUHOLE
一字

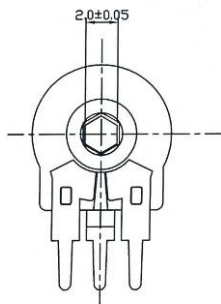

G=HEXAGONAL THRUHOLE
六角B

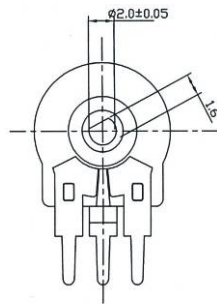

D=SHAPE D1 * D THRUHOLE
D字

Note: Specification are subject to change without notice. For more detail and update, please visit our website.