

## Austin Microlynx™ 12V SMT Non-isolated Power Modules: 10Vdc – 14Vdc input; 0.75Vdc to 5.5Vdc Output; 5A Output Current

### RoHS Compliant

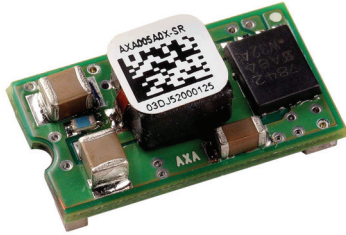

### Applications

- Distributed power architectures
- Intermediate bus voltage applications
- Telecommunications equipment
- Servers and storage applications
- Networking equipment
- Enterprise Networks
- Latest generation IC's (DSP, FPGA, ASIC) and Microprocessor powered applications

### Description

Austin MicroLynx™ 12Vdc SMT (surface mount technology) power modules are non-isolated dc-dc converters that can deliver up to 5A of output current with full load efficiency of 89% at 3.3V output. These modules provide precisely regulated output voltage programmable via external resistor from 0.75Vdc to 5.5Vdc over a wide range of input voltage ( $V_{IN} = 10 - 14V$ ). Their open-frame construction and small footprint enable designers to develop cost- and space-efficient solutions. Standard features include remote On/Off, programmable output voltage and overcurrent protection.

### Features

- Compliant to RoHS EU Directive 2002/95/EC (-Z versions)
- Compliant to ROHS EU Directive 2002/95/EC with lead solder exemption (non-Z versions)
- Delivers up to 5A output current
- High efficiency – 89% at 3.3V full load ( $V_{IN} = 12.0V$ )
- Small size and low profile:  
20.3 mm x 11.4 mm x 7.24 mm  
(0.8 in x 0.45 in x 0.285 in)
- Low output ripple and noise
- High Reliability:  
Calculated MTBF = 5.6M hours at 25°C Full-load
- Output voltage programmable from 0.75 Vdc to 5.5Vdc via external resistor
- Line Regulation: 0.3% (typical)
- Load Regulation: 0.4% (typical)
- Temperature Regulation: 0.4 % (typical)
- Remote On/Off
- Output overcurrent protection (non-latching)
- Wide operating temperature range (-40°C to 85°C)
- *UL*\* 60950-1 Recognized, *CSA*† C22.2 No. 60950-1-03 Certified, and *VDE*‡ 0805:2001-12 (EN60950-1) Licensed
- ISO\*\* 9001 and ISO 14001 certified manufacturing facilities

\* *UL* is a registered trademark of Underwriters Laboratories, Inc.

† *CSA* is a registered trademark of Canadian Standards Association.

‡ *VDE* is a trademark of Verband Deutscher Elektrotechniker e.V.

\*\* *ISO* is a registered trademark of the International Organization of Standards

## Absolute Maximum Ratings

Stresses in excess of the absolute maximum ratings can cause permanent damage to the device. These are absolute stress ratings only, functional operation of the device is not implied at these or any other conditions in excess of those given in the operations sections of the data sheet. Exposure to absolute maximum ratings for extended periods can adversely affect the device reliability.

Parameter	Device	Symbol	Min	Max	Unit
Input Voltage Continuous	All	$V_{IN}$	-0.3	15	Vdc
Operating Ambient Temperature (see Thermal Considerations section)	All	$T_A$	-40	85	°C
Storage Temperature	All	$T_{stg}$	-55	125	°C

## Electrical Specifications

Unless otherwise indicated, specifications apply over all operating input voltage, resistive load, and temperature conditions.

Parameter	Device	Symbol	Min	Typ	Max	Unit
Operating Input Voltage	All	$V_{IN}$	10	12	14	Vdc
Maximum Input Current ( $V_{IN} = V_{IN, min}$ to $V_{IN, max}$ , $I_O = I_{O, max}$ )	All	$I_{IN, max}$			3.5	Adc
Input No Load Current ( $V_{IN} = V_{IN, nom}$ , $I_O = 0$ , module enabled)	$V_{O, set} = 0.75$ Vdc  $V_{O, set} = 5.0$ Vdc	$I_{IN, No load}$		17  100		mA  mA
Input Stand-by Current ( $V_{IN} = V_{IN, nom}$ , module disabled)	All	$I_{IN, stand-by}$		1.2		mA
Inrush Transient	All	$I^2t$			0.4	A <sup>2</sup> s
Input Reflected Ripple Current, peak-to-peak (5Hz to 20MHz, 1μH source impedance; $V_{IN, min}$ to $V_{IN, max}$ , $I_O = I_{O, max}$ ; See Test configuration section)	All			30		mAp-p
Input Ripple Rejection (120Hz)	All			30		dB

### CAUTION: This power module is not internally fused. An input line fuse must always be used.

This power module can be used in a wide variety of applications, ranging from simple standalone operation to being part of a complex power architecture. To preserve maximum flexibility, internal fusing is not included, however, to achieve maximum safety and system protection, always use an input line fuse. The safety agencies require a fast-acting fuse with a maximum rating of 6 A (see Safety Considerations section). Based on the information provided in this data sheet on inrush energy and maximum dc input current, the same type of fuse with a lower rating can be used. Refer to the fuse manufacturer's data sheet for further information.

Electrical Specifications (continued)

Parameter	Device	Symbol	Min	Typ	Max	Unit
Output Voltage Set-point ( $V_{IN}=V_{IN, min}$ , $I_O=I_{O, max}$ , $T_A=25^\circ\text{C}$ )	All	$V_{O, set}$	-2.0	$V_{O, set}$	+2.0	% $V_{O, set}$
Output Voltage (Over all operating input voltage, resistive load, and temperature conditions until end of life)	All	$V_{O, set}$	-2.5%	—	+3.5%	% $V_{O, set}$
Adjustment Range Selected by an external resistor	All	$V_O$	0.7525		5.5	Vdc
Output Regulation Line ( $V_{IN}=V_{IN, min}$ to $V_{IN, max}$ ) Load ( $I_O=I_{O, min}$ to $I_{O, max}$ ) Temperature ( $T_{ref}=T_{A, min}$ to $T_{A, max}$ )	All All All		— — —	0.3 0.4 0.4	— — —	% $V_{O, set}$ % $V_{O, set}$ % $V_{O, set}$
Output Ripple and Noise on nominal output ( $V_{IN}=V_{IN, nom}$ and $I_O=I_{O, min}$ to $I_{O, max}$ Cout = 1 $\mu$ F ceramic//10 $\mu$ Ftantalum capacitors)						
RMS (5Hz to 20MHz bandwidth)	All		—	15	30	mV <sub>rms</sub>
Peak-to-Peak (5Hz to 20MHz bandwidth)	All		—	30	75	mV <sub>pk-pk</sub>
External Capacitance ESR $\geq$ 1 m $\Omega$ ESR $\geq$ 10 m $\Omega$	All All	$C_{O, max}$ $C_{O, max}$	— —	— —	1000 3000	$\mu$ F $\mu$ F
Output Current	All	$I_o$	0		5	Adc
Output Current Limit Inception (Hiccup Mode ) ( $V_O=90\%$ of $V_{O, set}$ )	All	$I_{o, lim}$	—	200	—	% $I_o$
Output Short-Circuit Current ( $V_O \leq 250\text{mV}$ ) ( Hiccup Mode )	All	$I_{o, s/c}$	—	2	—	Adc
Efficiency $V_{IN}=V_{IN, nom}$ , $T_A=25^\circ\text{C}$ $I_O=I_{O, max}$ , $V_O=V_{O, set}$	$V_{O, set} = 1.2\text{Vdc}$ $V_{O, set} = 1.5\text{Vdc}$ $V_{O, set} = 1.8\text{Vdc}$ $V_{O, set} = 2.5\text{Vdc}$ $V_{O, set} = 3.3\text{Vdc}$ $V_{O, set} = 5.0\text{Vdc}$	$\eta$ $\eta$ $\eta$ $\eta$ $\eta$ $\eta$		81.5 84.0 85.0 87.0 89.0 92.0		% % % % % %
Switching Frequency	All	$f_{sw}$	—	300	—	kHz
Dynamic Load Response ( $dI_O/dt=2.5\text{A}/\mu\text{s}$ ; $V_{IN} = V_{IN, nom}$ ; $T_A=25^\circ\text{C}$ ) Load Change from $I_O=50\%$ to $100\%$ of $I_{O, max}$ ; 1 $\mu$ F ceramic// 10 $\mu$ F tantalum Peak Deviation Settling Time ( $V_O < 10\%$ peak deviation)	All All	$V_{pk}$ $t_s$	— —	200 25	— —	mV $\mu$ s
( $dI_O/dt=2.5\text{A}/\mu\text{s}$ ; $V_{IN} = V_{IN, nom}$ ; $T_A=25^\circ\text{C}$ ) Load Change from $I_O=100\%$ to $50\%$ of $I_{O, max}$ : 1 $\mu$ F ceramic// 10 $\mu$ F tantalum Peak Deviation Settling Time ( $V_O < 10\%$ peak deviation)	All All	$V_{pk}$ $t_s$	— —	200 25	— —	mV $\mu$ s

### Electrical Specifications (continued)

Parameter	Device	Symbol	Min	Typ	Max	Unit
Dynamic Load Response (dI <sub>o</sub> /dt=2.5A/μs; V <sub>IN</sub> = V <sub>IN, nom</sub> ; T <sub>A</sub> =25°C) Load Change from I <sub>o</sub> = 50% to 100% of I <sub>o,max</sub> ; C <sub>o</sub> = 2x150 μF polymer capacitors Peak Deviation	All	V <sub>pk</sub>	—	50	—	mV
Settling Time (V <sub>o</sub> <10% peak deviation)	All	t <sub>s</sub>	—	50	—	μs
Dynamic Load Response (dI <sub>o</sub> /dt=2.5A/μs; V <sub>IN</sub> = V <sub>IN, nom</sub> ; T <sub>A</sub> =25°C) Load Change from I <sub>o</sub> = 100% to 50% of I <sub>o,max</sub> ; C <sub>o</sub> = 2x150 μF polymer capacitors Peak Deviation	All	V <sub>pk</sub>	—	50	—	mV
Settling Time (V <sub>o</sub> <10% peak deviation)	All	t <sub>s</sub>	—	50	—	μs

### General Specifications

Parameter	Min	Typ	Max	Unit
Calculated MTBF (I <sub>o</sub> =I <sub>o, max</sub> , T <sub>A</sub> =25°C)		5,677,000		Hours
Weight	—	2.8 (0.1)	—	g (oz.)

## Feature Specifications

Unless otherwise indicated, specifications apply over all operating input voltage, resistive load, and temperature conditions. See Feature Descriptions for additional information.

Parameter	Device	Symbol	Min	Typ	Max	Unit
Remote On/Off Signal interface ( $V_{IN}=V_{IN, min}$ to $V_{IN, max}$ ; Open collector pnp or equivalent Compatible, Von/off signal referenced to GND See feature description section) Logic Low (On/Off Voltage pin open - Module ON)						
Von/Off	All	$V_{IL}$	—	—	0.4	V
Ion/Off	All	$I_{IL}$	—	—	10	$\mu A$
Logic High (Von/Off > 2.5V – Module Off)						
Von/Off	All	$V_{IH}$	—	—	$V_{IN, max}$	V
Ion/off	All	$I_{IH}$	—	—	1	mA
Turn-On Delay and Rise Times ( $I_O=I_{O, max}$ , $V_{IN} = V_{IN, nom}$ , $T_A = 25^\circ C$ , )						
Case 1: On/Off input is set to Logic Low (Module ON) and then input power is applied (delay from instant at which $V_{IN} = V_{IN, min}$ until $V_O=10\%$ of $V_{O, set}$ )	All	Tdelay	—	3	—	msec
Case 2: Input power is applied for at least one second and then the On/Off input is set to logic Low (delay from instant at which Von/Off=0.3V until $V_O=10\%$ of $V_{O, set}$ )	All	Tdelay	—	3	—	msec
Output voltage Rise time (time for $V_O$ to rise from 10% of $V_{O, set}$ to 90% of $V_{O, set}$ )	All	Trise	—	4	6	msec
Output voltage overshoot – Startup $I_O= I_{O, max}$ ; $V_{IN} = 10$ to 14Vdc, $T_A = 25^\circ C$				—	1	% $V_{O, set}$
Overtemperature Protection (See Thermal Consideration section)	All	$T_{ref}$	—	140	—	$^\circ C$
Input Undervoltage Lockout						
Turn-on Threshold	All			8.2		V
Turn-off Threshold	All			8.0		V

### Characteristic Curves

The following figures provide typical characteristics for the Austin MicroLynx™ 12V SMT modules at 25°C.

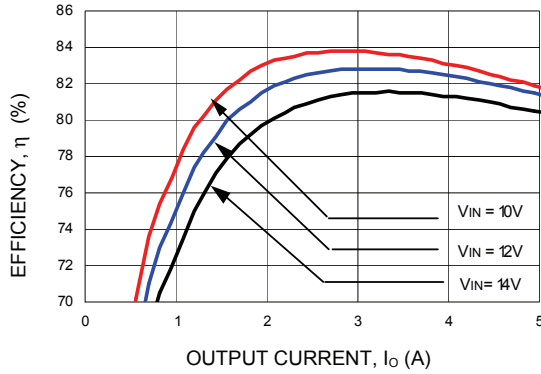

Figure 1. Converter Efficiency versus Output Current ( $V_{out} = 1.2Vdc$ ).

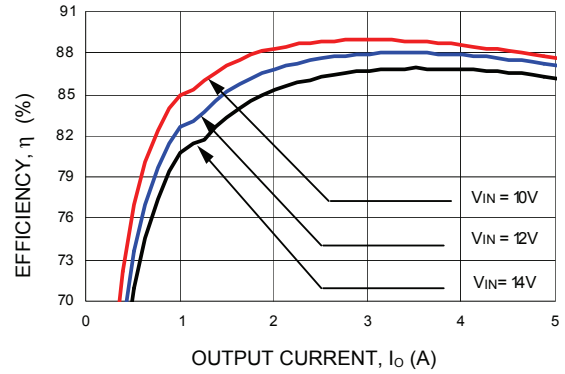

Figure 4. Converter Efficiency versus Output Current ( $V_{out} = 2.5Vdc$ ).

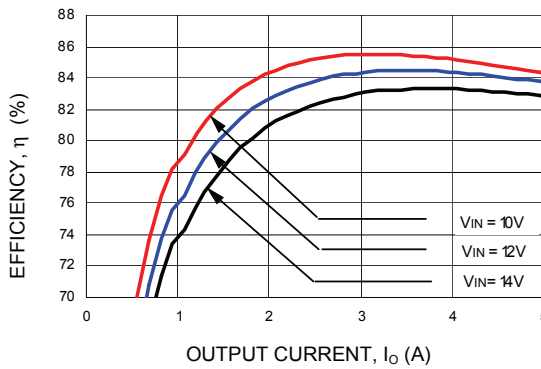

Figure 2. Converter Efficiency versus Output Current ( $V_{out} = 1.5Vdc$ ).

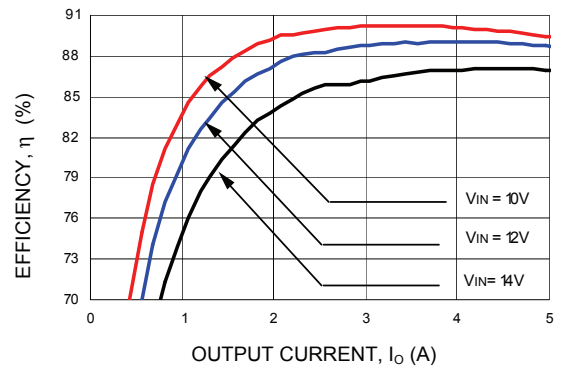

Figure 5. Converter Efficiency versus Output Current ( $V_{out} = 3.3Vdc$ ).

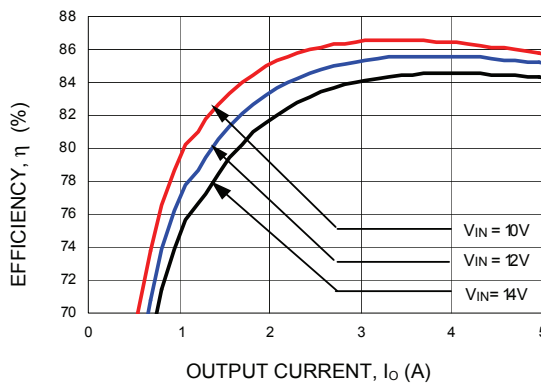

Figure 3. Converter Efficiency versus Output Current ( $V_{out} = 1.8Vdc$ ).

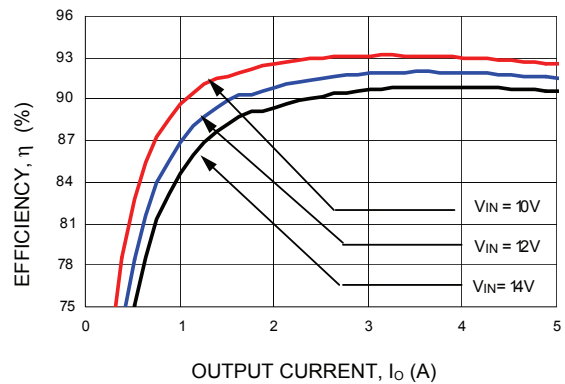

Figure 6. Converter Efficiency versus Output Current ( $V_{out} = 5.0Vdc$ ).

Characteristic Curves (continued)

The following figures provide typical characteristics for the MicroLynx™ 12V SMT modules at 25°C.

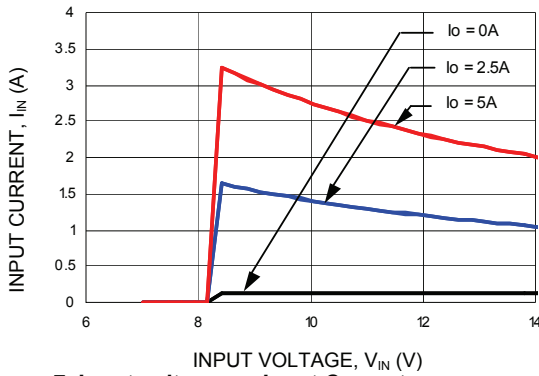

Figure 7. Input voltage vs. Input Current  
 (Vout = 5.0Vdc).

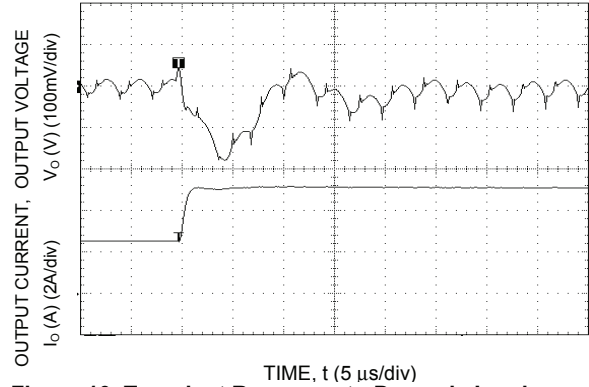

Figure 10. Transient Response to Dynamic Load Change from 50% to 100% of full load (Vo = 3.3Vdc).

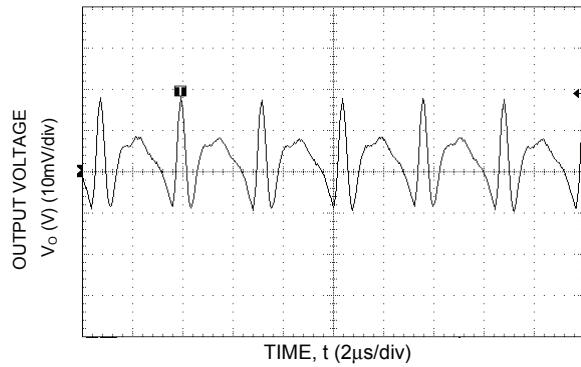

Figure 8. Typical Output Ripple and Noise  
 (Vin = 12V dc, Vo = 0.75 Vdc, I\_o=5A).

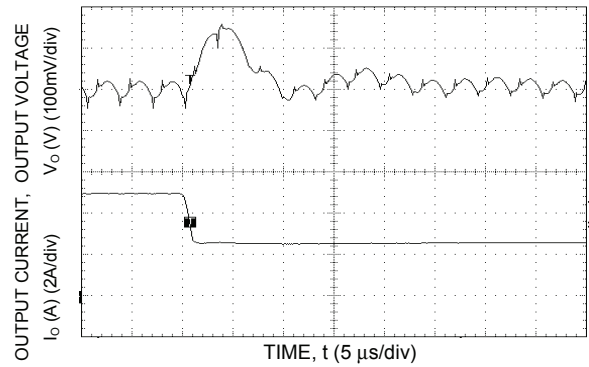

Figure 11. Transient Response to Dynamic Load Change from 100% to 50% of full load (Vo = 3.3 Vdc).

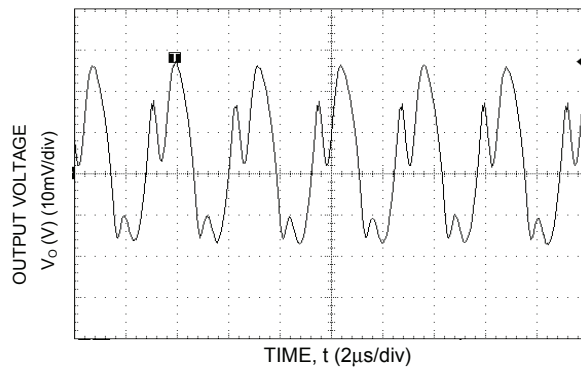

Figure 9. Typical Output Ripple and Noise  
 (Vin = 12.0V dc, Vo = 5.0 Vdc, I\_o=5A).

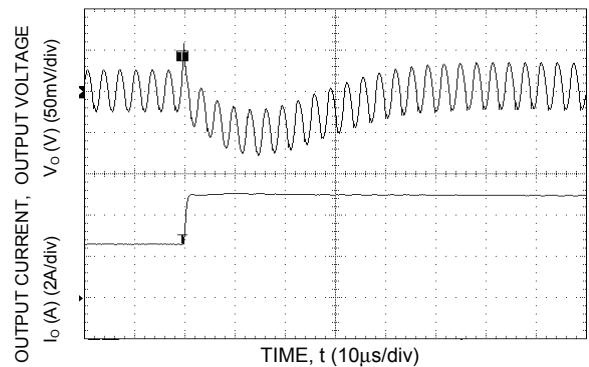

Figure 12. Transient Response to Dynamic Load Change from 50% to 100% of full load (Vo = 5.0 Vdc, Cext = 2x150 μF Polymer Capacitors).

Characteristic Curves (continued)

The following figures provide typical characteristics for the Austin MicroLynx™ 12V SMT modules at 25°C.

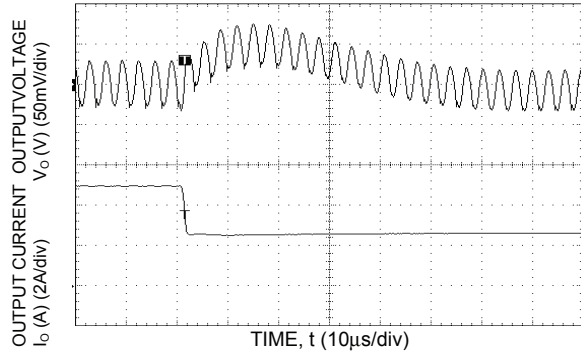

Figure 13. Transient Response to Dynamic Load Change from 100% of 50% full load ( $V_o = 5.0\text{ Vdc}$ ,  $C_{ext} = 2 \times 150\ \mu\text{F}$  Polymer Capacitors).

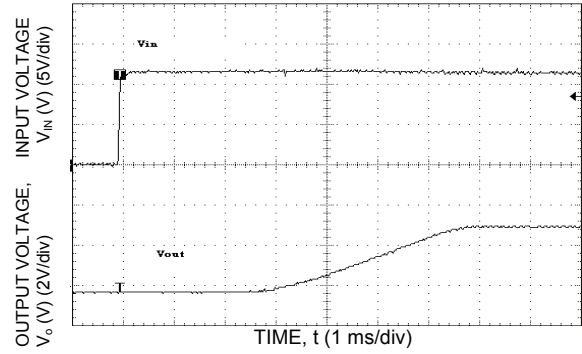

Figure 16. Typical Start-Up with application of  $V_{in}$  with ( $V_{in} = 12\text{ Vdc}$ ,  $V_o = 3.3\text{ Vdc}$ ,  $I_o = 5\text{ A}$ ).

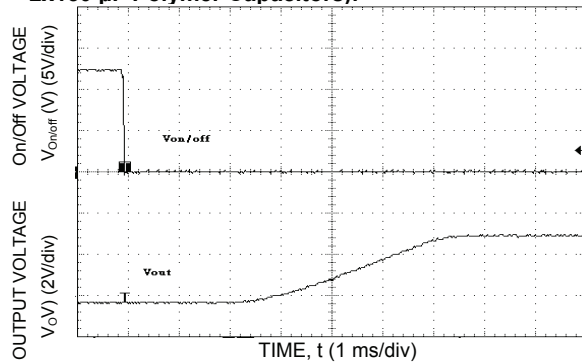

Figure 14. Typical Start-Up Using Remote On/Off ( $V_{in} = 12\text{ Vdc}$ ,  $V_o = 3.3\text{ Vdc}$ ,  $I_o = 5.0\text{ A}$ ).

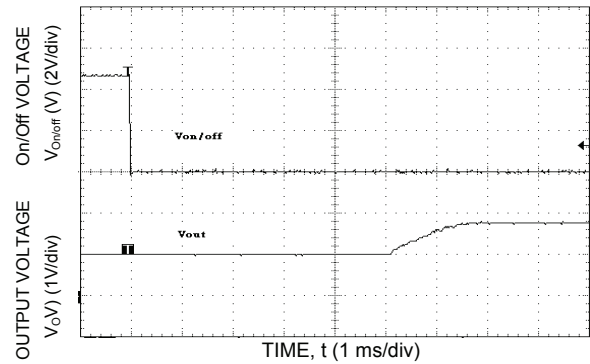

Figure 17 Typical Start-Up using Remote On/off with Prebias ( $V_{in} = 12\text{ Vdc}$ ,  $V_o = 1.8\text{ Vdc}$ ,  $I_o = 1\text{ A}$ ,  $V_{bias} = 1.0\text{ Vdc}$ ).

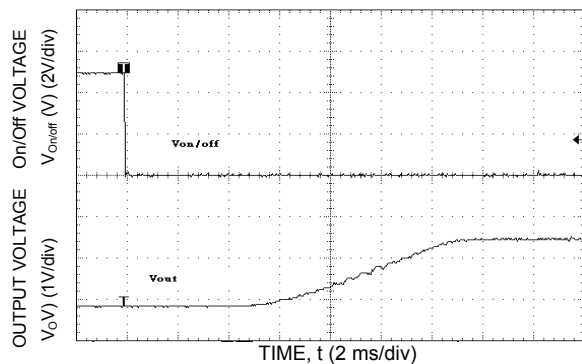

Figure 15. Typical Start-Up Using Remote On/Off with Low-ESR external capacitors ( $7 \times 150\ \mu\text{F}$  Polymer) ( $V_{in} = 12\text{ Vdc}$ ,  $V_o = 3.3\text{ Vdc}$ ,  $I_o = 5.0\text{ A}$ ,  $C_o = 1050\ \mu\text{F}$ ).

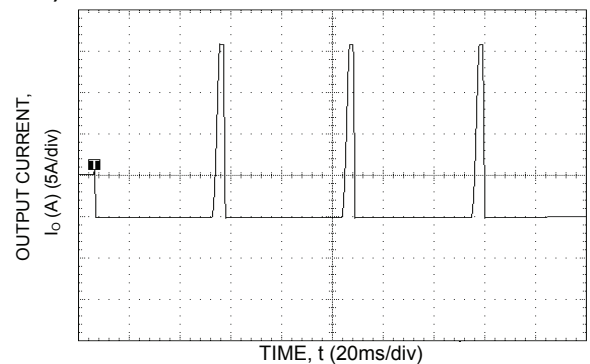

Figure 18. Output short circuit Current ( $V_{in} = 12\text{ Vdc}$ ,  $V_o = 0.75\text{ Vdc}$ ).



Characteristic Curves (continued)

The following figures provide thermal derating curves for the Austin MicroLynx™ 12V SMT modules.

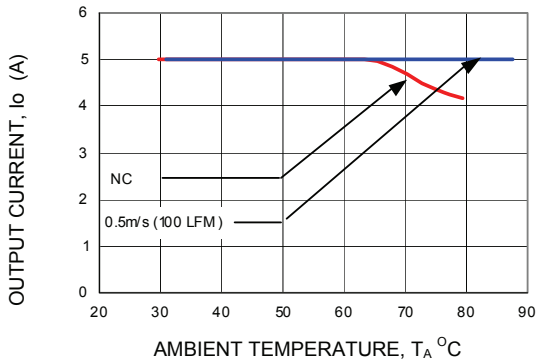

Figure 19. Derating Output Current versus Local Ambient Temperature and Airflow ( $V_{in} = 12Vdc$ ,  $V_o=0.75Vdc$ ).

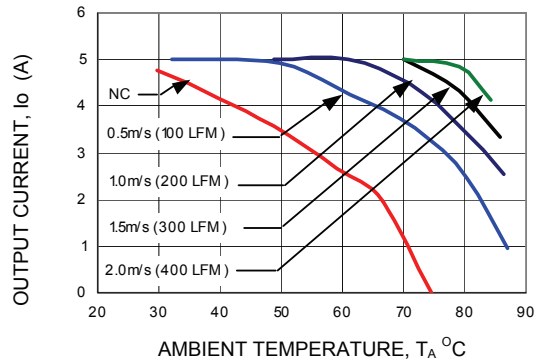

Figure 22. Derating Output Current versus Local Ambient Temperature and Airflow ( $V_{in} = 12Vdc$ ,  $V_o=5.0 Vdc$ ).

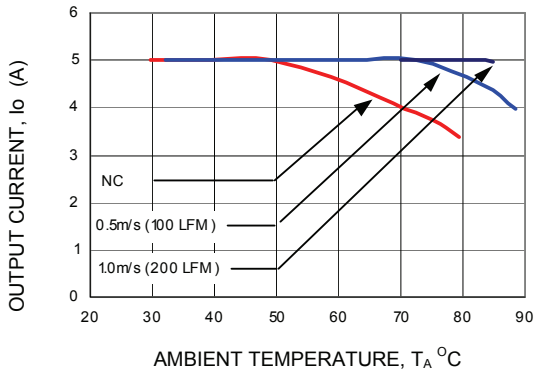

Figure 20. Derating Output Current versus Local Ambient Temperature and Airflow ( $V_{in} = 12Vdc$ ,  $V_o=1.8 Vdc$ ).

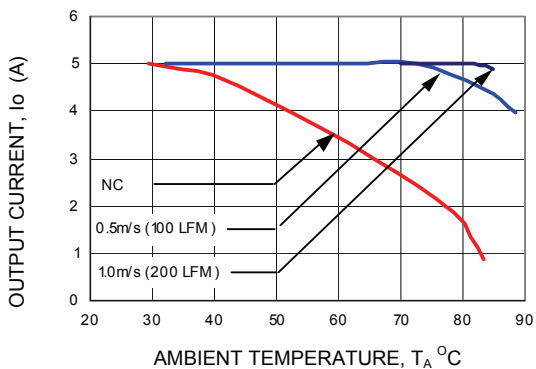
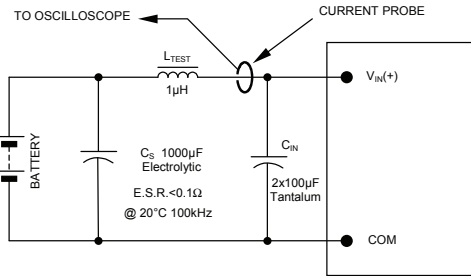

Figure 21. Derating Output Current versus Local Ambient Temperature and Airflow ( $V_{in} = 12Vdc$ ,  $V_o=3.3 Vdc$ ).

### Test Configurations



NOTE: Measure input reflected ripple current with a simulated source inductance ( $L_{TEST}$ ) of 1µH. Capacitor  $C_S$  offsets possible battery impedance. Measure current as shown above.

Figure 23. Input Reflected Ripple Current Test Setup.

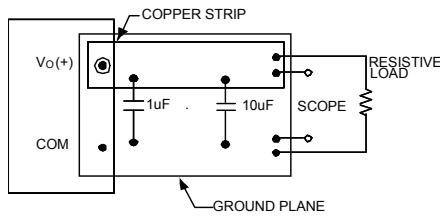

NOTE: All voltage measurements to be taken at the module terminals, as shown above. If sockets are used then Kelvin connections are required at the module terminals to avoid measurement errors due to socket contact resistance.

Figure 24. Output Ripple and Noise Test Setup.

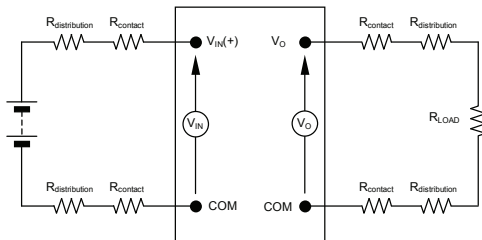

NOTE: All voltage measurements to be taken at the module terminals, as shown above. If sockets are used then Kelvin connections are required at the module terminals to avoid measurement errors due to socket contact resistance.

Figure 25. Output Voltage and Efficiency Test Setup.

$$\text{Efficiency } \eta = \frac{V_O \cdot I_O}{V_{IN} \cdot I_{IN}} \times 100 \%$$

### Design Considerations

#### Input Filtering

The Austin MicroLynx™ 12V SMT module should be connected to a low-impedance source. A highly inductive source can affect the stability of the module. An input capacitance must be placed directly adjacent to the input pin of the module, to minimize input ripple voltage and ensure module stability.

In a typical application, 2x47 µF low-ESR tantalum capacitors (AVX part #: TPSE476M025R0100, 47µF 25V 100 mΩ ESR tantalum capacitor) will be sufficient to provide adequate ripple voltage at the input of the module. To minimize ripple voltage at the input, low ESR ceramic capacitors are recommended at the input of the module. Figure 26 shows input ripple voltage (mVp-p) for various outputs with 2x47 µF tantalum capacitors and with 2x22 µF ceramic capacitor (TDK part #: C4532X5R1C226M) at full load.

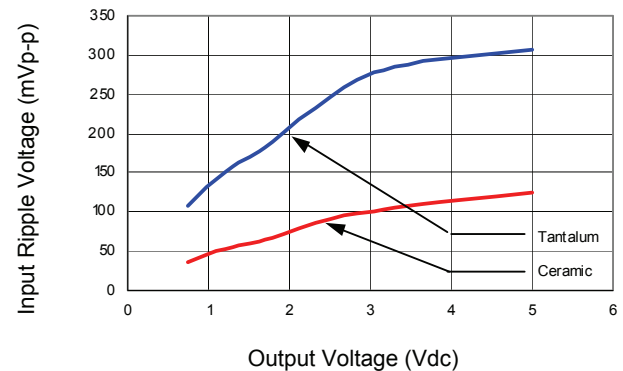

Figure 26. Input ripple voltage for various output with 2x47 µF tantalum capacitors and with 2x22 µF ceramic capacitors at the input (80% of  $I_{o,max}$ ).

## Design Considerations (continued)

### Output Filtering

The Austin MicroLynx™ 12V module is designed for low output ripple voltage and will meet the maximum output ripple specification with 1  $\mu$ F ceramic and 10  $\mu$ F polymer capacitors at the output of the module. However, additional output filtering may be required by the system designer for a number of reasons. First, there may be a need to further reduce the output ripple and noise of the module. Second, the dynamic response characteristics may need to be customized to a particular load step change.

To reduce the output ripple and improve the dynamic response to a step load change, additional capacitance at the output can be used. Low ESR polymer and ceramic capacitors are recommended to improve the dynamic response of the module. For stable operation of the module, limit the capacitance to less than the maximum output capacitance as specified in the electrical specification table.

## Safety Considerations

For safety agency approval the power module must be installed in compliance with the spacing and separation requirements of the end-use safety agency standards, i.e., UL 60950-1, CSA C22.2 No. 60950-1-03, and VDE 0850:2001-12 (EN60950-1) Licensed.

For the converter output to be considered meeting the requirements of safety extra-low voltage (SELV), the input must meet SELV requirements. The power module has extra-low voltage (ELV) outputs when all inputs are ELV.

The input to these units is to be provided with a fast-acting fuse with a maximum rating of 6A in the positive input lead.

## Feature Description

### Remote On/Off

The Austin MicroLynx™ SMT 12V power modules feature an On/Off pin for remote On/Off operation of the module. If not using the remote On/Off pin, leave the pin open (module will be On). The On/Off pin signal ( $V_{On/Off}$ ) is referenced to ground. To switch module on and off using remote On/Off, connect an open collector pnp transistor between the On/Off pin and the  $V_{IN}$  pin (See Figure 27).

When the transistor Q1 is in the OFF state, the power module is ON (Logic Low on the On/Off pin of the module) and the maximum  $V_{On/off}$  of the module is 0.4 V. The maximum allowable leakage current of the transistor when  $V_{On/off} = 0.4V$  and  $V_{IN} = V_{IN,max}$  is  $10\mu A$ . During a logic-high when the transistor is in the active state, the power module is OFF. During this state  $V_{On/Off} = 10 - 14V$  and the maximum  $I_{On/Off} = 1mA$ .

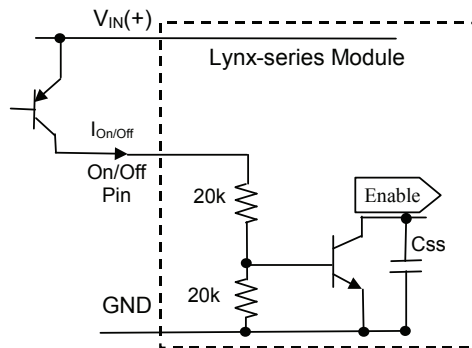

Figure 27. Remote On/Off Implementation

Remote On/Off can also be implemented using open-collector logic devices with an external pull-up resistor. Figure 28a shows the circuit configuration using this approach. Pull-up resistor,  $R_{pull-up}$ , for the configuration should be  $68k (+/-5\%)$  for proper operation of the module over the entire temperature range.

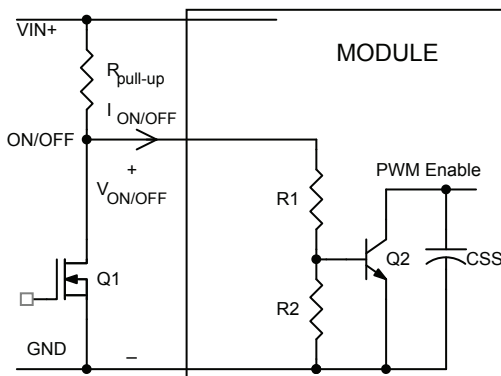

Figure 27a. Remote On/Off Implementation using logic-level devices and an external pull-up resistor

### Overcurrent Protection

To provide protection in a fault (output overload) condition, the unit is equipped with internal current-limiting circuitry and can endure current limiting continuously. At the point of current-limit inception, the unit enters hiccup mode. The unit operates normally once the output current is brought back into its specified range. The typical average output current during hiccup is 2A.

### Input Undervoltage Lockout

At input voltages below the input undervoltage lockout limit, module operation is disabled. The module will begin to operate at an input voltage above the undervoltage lockout turn-on threshold.

### Overtemperature Protection

To provide over temperature protection in a fault condition, the unit relies upon the thermal protection feature of the controller IC. The unit will shutdown if the thermal reference point  $T_{ref2}$ , (see Figure 31) exceeds  $140^{\circ}C$  (typical), but the thermal shutdown is not intended as a guarantee that the unit will survive temperatures beyond its rating. The module will automatically restarts after it cools down.

## Feature Descriptions (continued)

### Output Voltage Programming

The output voltage of the Austin MicroLynx™ 12V can be programmed to any voltage from 0.75Vdc to 5.5Vdc by

connecting a resistor (shown as  $R_{trim}$  in Figure 28) between Trim and GND pins of the module. Without an external resistor between Trim and GND pins, the output of the module will be 0.7525Vdc. To calculate the value of the trim resistor,  $R_{trim}$  for a desired output voltage, use the following equation:

$$R_{trim} = \left[ \frac{10500}{V_o - 0.7525} - 1000 \right] \Omega$$

$R_{trim}$  is the external resistor in  $\Omega$

$V_o$  is the desired output voltage

For example, to program the output voltage of the Austin MicroLynx™ 12V module to 1.8V,  $R_{trim}$  is calculated as follows:

$$R_{trim} = \left[ \frac{10500}{1.8 - 0.7525} - 1000 \right]$$

$$R_{trim} = 9.024k\Omega$$

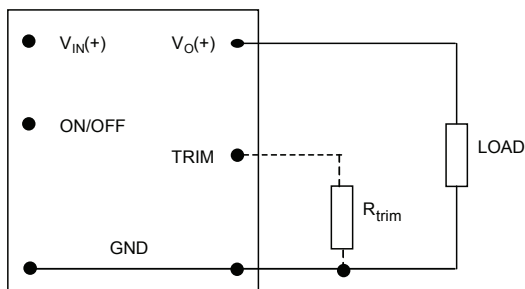

Figure 28. Circuit configuration to program output voltage using an external resistor

Austin MicroLynx™ 12Vdc can also be programmed by applying a voltage between TRIM and GND pins (Figure 29). The following equation can be used to determine the value of  $V_{trim}$  needed to obtain a desired output voltage  $V_o$ :

$$V_{trim} = (0.7 - 0.0667 \times \{V_o - 0.7525\})$$

For example, to program the output voltage of a MicroLynx™ module to 3.3 Vdc,  $V_{trim}$  is calculated as follows:

$$V_{trim} = (0.7 - 0.0667 \times \{3.3 - 0.7525\})$$

$$V_{trim} = 0.530V$$

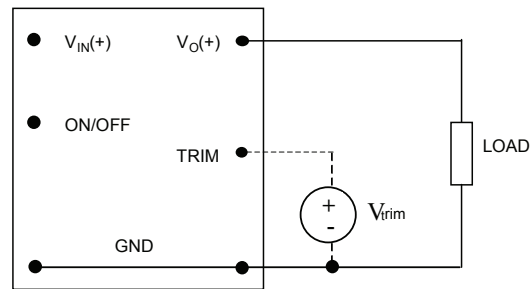

Figure 29. Circuit Configuration for programming Output voltage using external voltage source

Table 1 provides  $R_{trim}$  values for most common output voltages. Table 2 provides values of external voltage source,  $V_{trim}$  for various output voltage.

Table 1

$V_{O, set}$ (V)	$R_{trim}$ (K $\Omega$ )
0.7525	Open
1.2	22.46
1.5	13.05
1.8	9.024
2.5	5.009
3.3	3.122
5.0	1.472

Table 2

$V_{O, set}$ (V)	$V_{trim}$ (V)
0.7525	Open
1.2	0.670
1.5	0.650
1.8	0.630
2.5	0.583
3.3	0.530
5.0	0.4166

Using 1% tolerance trim resistor, set point tolerance of  $\pm 2\%$  is achieved as specified in the electrical specification. The POL Programming Tool, available at [www.lineagepower.com](http://www.lineagepower.com) under the Design Tools section, helps determine the required external trim resistor needed for a specific output voltage.

## Feature Descriptions (continued)

The amount of power delivered by the module is defined as the voltage at the output terminals multiplied by the output current. When using the trim feature, the output voltage of the module can be increased, which at the same output current would increase the power output of the module. Care should be taken to ensure that the maximum output power of the module remains at or below the maximum rated power ( $P_{max} = V_{o,set} \times I_{o,max}$ ).

## Voltage Margining

Output voltage margining can be implemented in the Austin MicroLynx™ modules by connecting a resistor,  $R_{margin-up}$ , from Trim pin to ground pin for margining-up the output voltage and by connecting a resistor,  $R_{margin-down}$ , from Trim pin to Output pin. Figure 30 shows the circuit configuration for output voltage margining. The POL Programming Tool, available at [www.lineagepower.com](http://www.lineagepower.com) under the Design Tools section, also calculates the values of  $R_{margin-up}$  and  $R_{margin-down}$  for a specific output voltage and % margin. Please consult your local Lineage Power technical representative for additional details

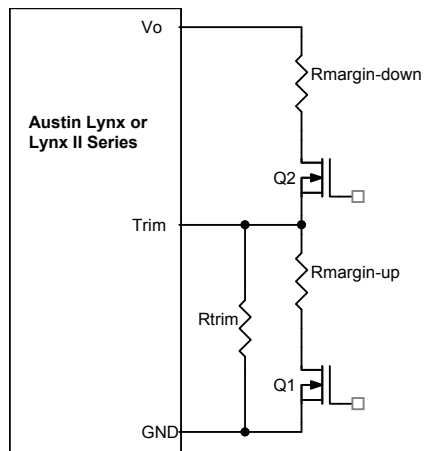

Figure 30. Circuit Configuration for margining Output voltage.

## Thermal Considerations

Power modules operate in a variety of thermal environments; however, sufficient cooling should be provided to help ensure reliable operation.

Considerations include ambient temperature, airflow, module power dissipation, and the need for increased reliability. A reduction in the operating temperature of the module will result in an increase in reliability. The thermal data presented here is based on physical measurements taken in a wind tunnel. The test set-up is shown in Figure 32. Note that the airflow is parallel to the long axis of the module as shown in figure 31. The derating data applies to airflow in either direction of the module's long axis.

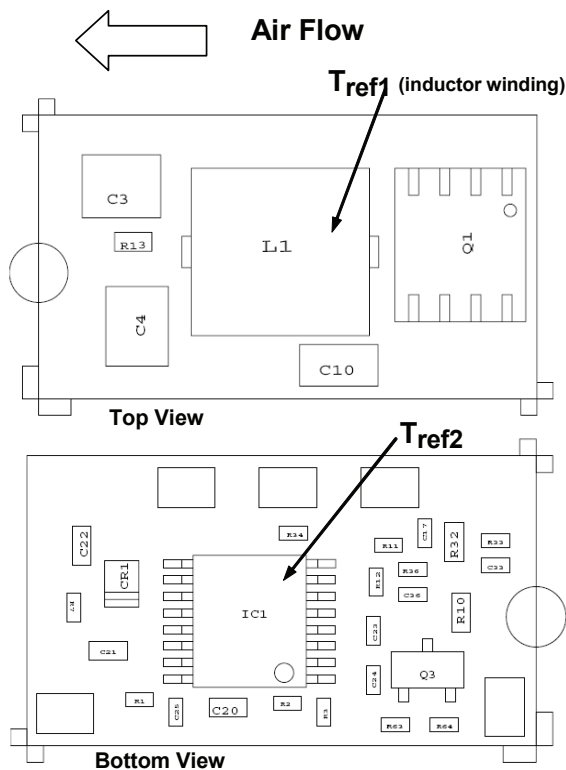

Figure 31.  $T_{ref}$  Temperature measurement location.

The thermal reference points,  $T_{ref1}$  and  $T_{ref2}$  used in the specifications of thermal derating curves are shown in Figure 31. For reliable operation these temperatures should not exceed 125°C.

The output power of the module should not exceed the rated power of the module ( $V_{o,set} \times I_{o,max}$ ).

Please refer to the Application Note “Thermal Characterization Process For Open-Frame Board-Mounted Power Modules” for a detailed discussion of thermal aspects including maximum device temperatures.

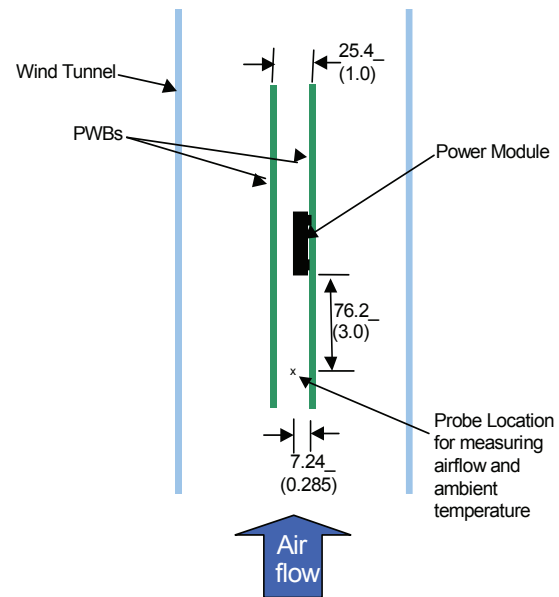

Figure 32. Thermal Test Set-up.

### Heat Transfer via Convection

Increased airflow over the module enhances the heat transfer via convection. Thermal derating curves showing the maximum output current that can be delivered by various module versus local ambient temperature ( $T_A$ ) for natural convection and up to 1m/s (200 ft./min) are shown in the Characteristics Curves section.

### Layout Considerations

Copper paths must not be routed beneath the power module. For additional layout guide-lines, refer to FLTR100V10 application note.

### Mechanical Outline

Dimensions are in millimeters and (inches).

Tolerances: x.x mm ± 0.5 mm (x.xx in. ± 0.02 in.) [unless otherwise indicated]

x.xx mm ± 0.25 mm (x.xxx in ± 0.010 in.)

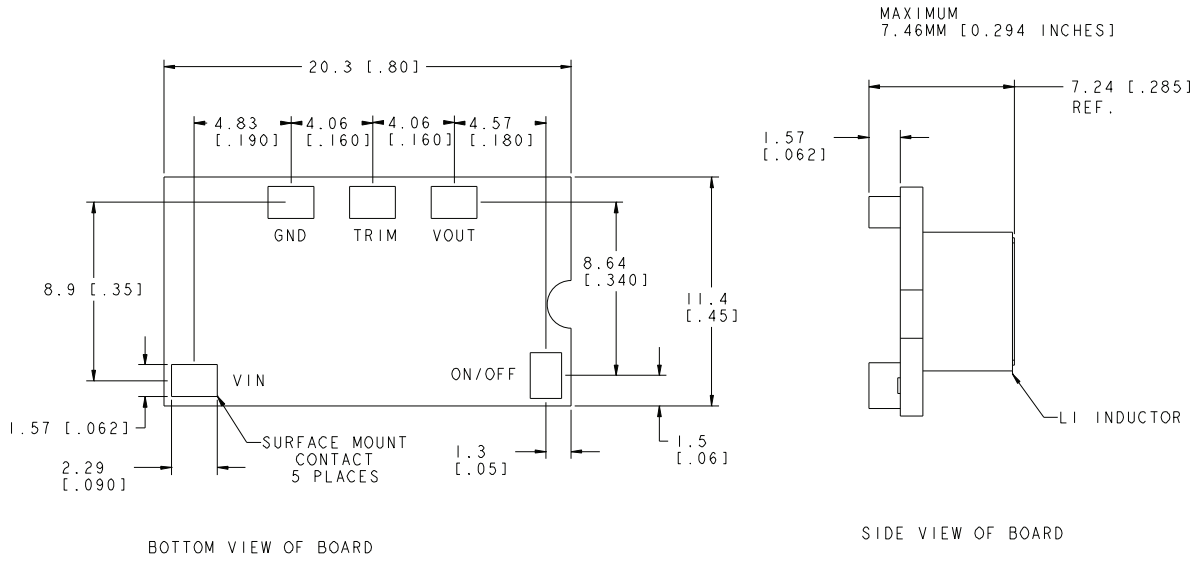

**Co-planarity (max): 0.102 [0.004]**

PIN	FUNCTION
1	On/Off
2	V <sub>IN</sub>
3	GND
4	Trim
5	V <sub>OUT</sub>



### Recommended Pad Layout

Dimensions are in millimeters and (inches).

Tolerances: x.x mm ± 0.5 mm (x.xx in. ± 0.02 in.) [unless otherwise indicated]

x.xx mm ± 0.25 mm (x.xxx in ± 0.010 in.)

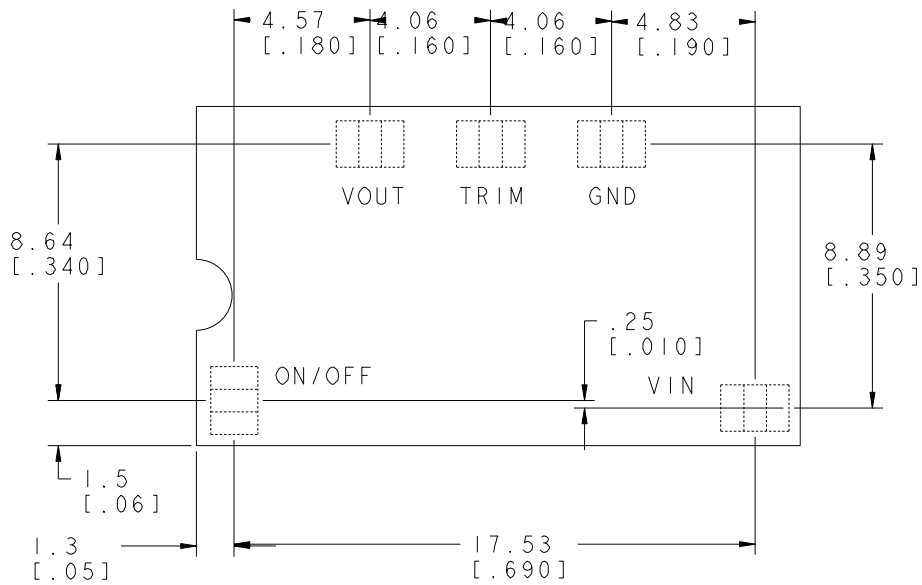

RECOMMENDED PAD LAYOUT  
 PAD SIZE:  
 MIN: 0.120" X 0.095"  
 MAX: 0.135" X 0.110"

PIN	FUNCTION
1	On/Off
2	V <sub>IN</sub>
3	GND
4	Trim
5	V <sub>OUT</sub>

### Packaging Details

The Austin MicroLynx™ 12V SMT versions are supplied in tape & reel as standard. Modules are shipped in quantities of 400 modules per reel.

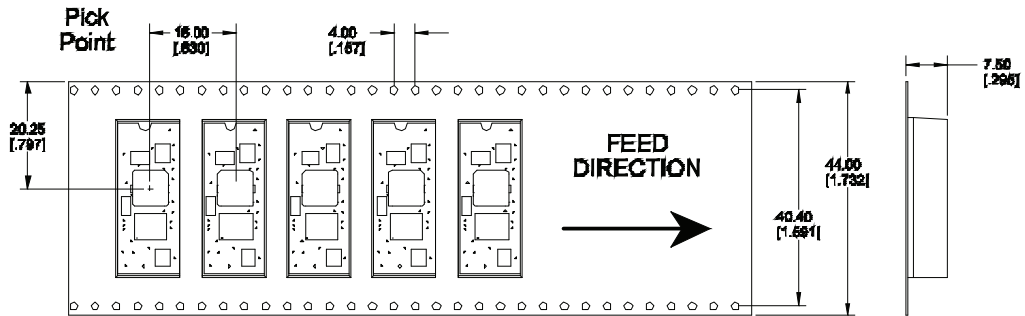

### Surface Mount Tape & Reel

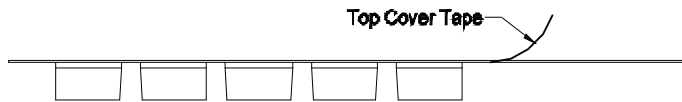

All Dimensions are in millimeters and (in inches).

#### Reel Dimensions

Outside Dimensions:	330.2 mm (13.00)
Inside Dimensions:	177.8 mm (7.00")
Width	44.0 mm (1.73")

## Surface Mount Information

### Pick and Place

The Austin MicroLynx™ 12V SMT modules use an open frame construction and are designed for a fully automated assembly process. The modules are fitted with a label designed to provide a large surface area for pick and placing. The label meets all the requirements for surface mount processing, as well as safety standards and is able to withstand maximum reflow temperature. The label also carries product information such as product code, serial number and location of manufacture.

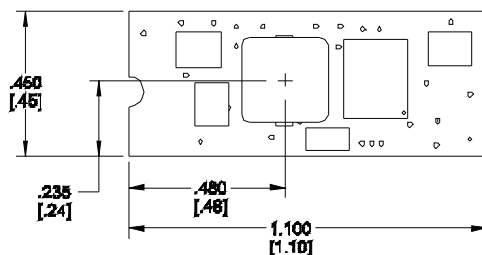

Figure 33. Pick and Place Location.

### Nozzle Recommendations

The module weight has been kept to a minimum by using open frame construction. Even so, these modules have a relatively large mass when compared to conventional SMT components. Variables such as nozzle size, tip style, vacuum pressure and pick & placement speed should be considered to optimize this process. The minimum recommended nozzle diameter for reliable operation is 3mm. The maximum nozzle outer diameter, which will safely fit within the allowable component spacing, is 8 mm max.

### Tin Lead Soldering

The Austin MicroLynx™ 12V SMT power modules are lead free modules and can be soldered either in a lead-free solder process or in a conventional Tin/Lead (Sn/Pb) process. It is recommended that the customer review data sheets in order to customize the solder reflow profile for each application board assembly. The following instructions must be observed when soldering these units. Failure to observe these instructions may result in the failure of or cause damage to the modules, and can adversely affect long-term reliability.

In a conventional Tin/Lead (Sn/Pb) solder process peak reflow temperatures are limited to less than 235°C. Typically, the eutectic solder melts at 183°C,

wets the land, and subsequently wicks the device connection. Sufficient time must be allowed to fuse the plating on the connection to ensure a reliable solder joint. There are several types of SMT reflow technologies currently used in the industry. These surface mount power modules can be reliably soldered using natural forced convection, IR (radiant infrared), or a combination of convection/IR. For reliable soldering the solder reflow profile should be established by accurately measuring the modules CP connector temperatures.

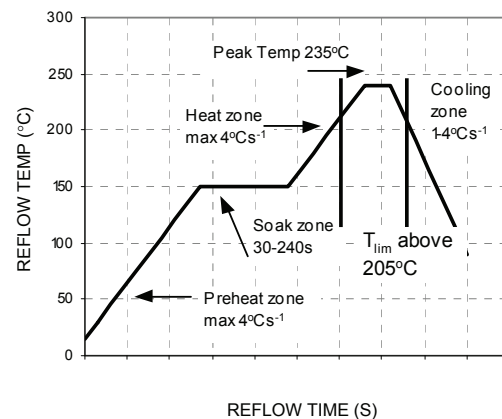

Figure 34. Reflow Profile for Tin/Lead (Sn/Pb) process.

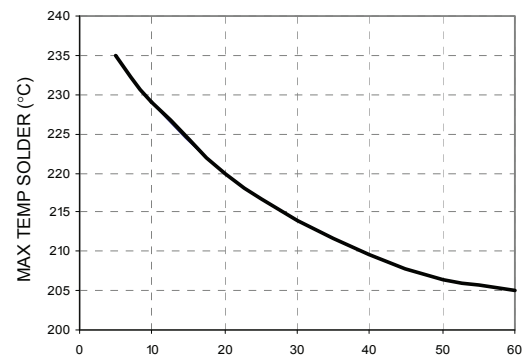

Figure 35. Time Limit Curve Above 205°C for Tin/Lead (Sn/Pb) process.

## Surface Mount Information (continued)

### Lead Free Soldering

The –Z version Austin MicroLynx 12V SMT modules are lead-free (Pb-free) and RoHS compliant and are both forward and backward compatible in a Pb-free and a SnPb soldering process. Failure to observe the instructions below may result in the failure of or cause damage to the modules and can adversely affect long-term reliability.

### Pb-free Reflow Profile

Power Systems will comply with J-STD-020 Rev. C (Moisture/Reflow Sensitivity Classification for Nonhermetic Solid State Surface Mount Devices) for both Pb-free solder profiles and MSL classification procedures. This standard provides a recommended forced-air-convection reflow profile based on the volume and thickness of the package (table 4-2). The suggested Pb-free solder paste is Sn/Ag/Cu (SAC). The recommended linear reflow profile using Sn/Ag/Cu solder is shown in Fig. 36.

### MSL Rating

The Austin MicroLynx 12V SMT modules have a MSL rating of 2..

### Storage and Handling

The recommended storage environment and handling procedures for moisture-sensitive surface mount packages is detailed in J-STD-033 Rev. A (Handling, Packing, Shipping and Use of Moisture/Reflow Sensitive Surface Mount Devices). Moisture barrier bags (MBB) with desiccant are required for MSL ratings of 2 or greater. These sealed packages should not be broken until time of use. Once the original package is broken, the floor life of the product at conditions of  $\leq 30^{\circ}\text{C}$  and 60% relative humidity varies according to the MSL rating (see J-STD-033A). The shelf life for dry packed SMT packages will be a minimum of 12 months from the bag seal date, when stored at the following conditions:  $< 40^{\circ}\text{C}$ ,  $< 90\%$  relative humidity.

### Post Solder Cleaning and Drying Considerations

Post solder cleaning is usually the final circuit-board assembly process prior to electrical board testing. The result of inadequate cleaning and drying can affect both the reliability of a power module and the testability of the finished circuit-board assembly. For guidance on appropriate soldering, cleaning and drying procedures, refer to *Board Mounted Power*

Modules: Soldering and Cleaning Application Note (AN04-001).

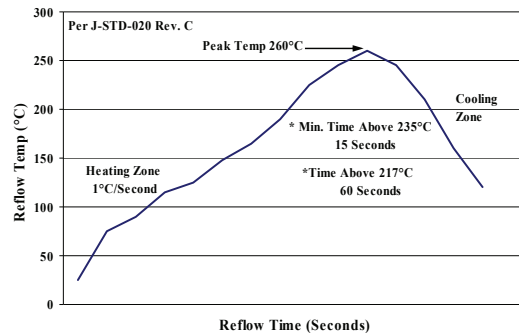

Figure 36. Recommended linear reflow profile using Sn/Ag/Cu solder.

## Ordering Information

Please contact your Lineage Power representative for pricing, availability and optional features.

**Table 3. Device Codes**

Device Code	Input Voltage Range	Output Voltage	Output Current	Efficiency 3.3V@ 6A	On/Off Logic	Connector Type	Comcodes
AXA005A0X-SR	10 – 14Vdc	0.75 – 5.5Vdc	5 A	89.0%	Negative	SMT	108981622
AXA005A0X-SRZ	10 – 14Vdc	0.75 – 5.5Vdc	5 A	89.0%	Negative	SMT	108995172

-Z refers to RoHS compliant versions



**LINEAGE POWER**

**World Wide Headquarters**  
**Lineage Power Corporation**  
3000 Skyline Drive, Mesquite, TX 75149, USA  
**+1-800-526-7819**  
(Outside U.S.A.: **+1-972-284-2626**)  
**www.lineagepower.com**  
**e-mail: techsupport1@lineagepower.com**

**Asia-Pacific Headquarters**  
Tel: +65 6416 4283

**Europe, Middle-East and Africa Headquarters**  
Tel: +49 89 6089 286

**India Headquarters**  
Tel: +91 80 28411633

Lineage Power reserves the right to make changes to the product(s) or information contained herein without notice. No liability is assumed as a result of their use or application. No rights under any patent accompany the sale of any such product(s) or information.

© 2008 Lineage Power Corporation, (Mesquite, Texas) All International Rights Reserved.