

## Hermetic, 50 Mil Pitch, Leadless Chip Resistor Networks

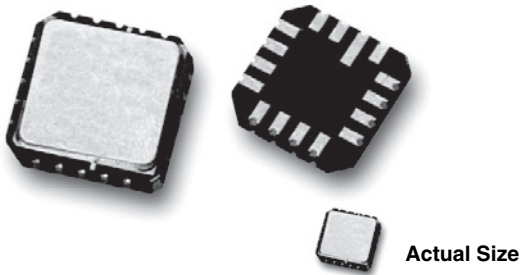

Capable of meeting the characteristics of MIL-PRF-83401 these networks are available in a wide range of resistance values: several standard configurations are presented with the SLCC series.

**FEATURES**

- High stability Ultrafilm (0.05 % at 1000 h at 70 °C under Pn)
- Low noise < 35 dB
- Hermetic package



**RoHS**  
COMPLIANT

**TYPICAL PERFORMANCE**

	ABS	TRACKING
TCR	25 ppm/°C	2 ppm/°C
	ABS	RATIO
TOL	0.1 %	0.1 %

Resistance Range: Noted on schematics

**SCHEMATIC**

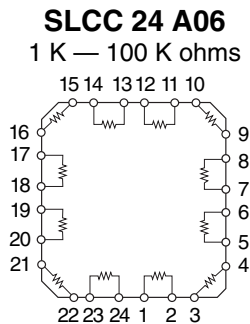
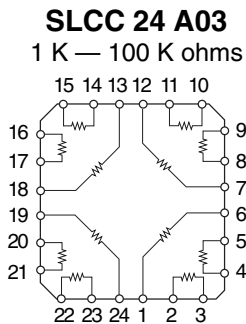
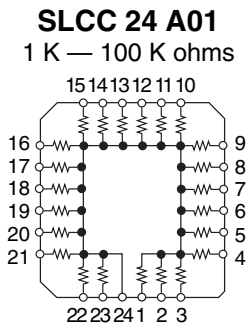
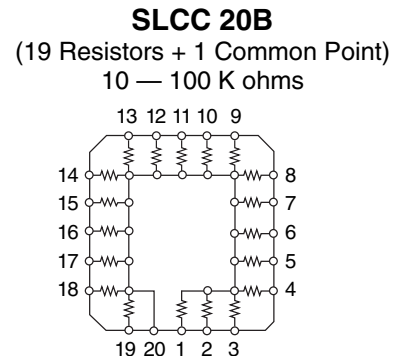
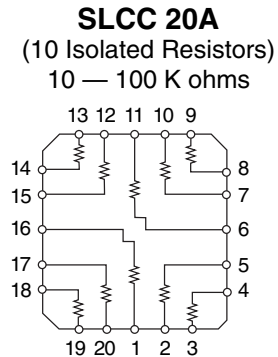
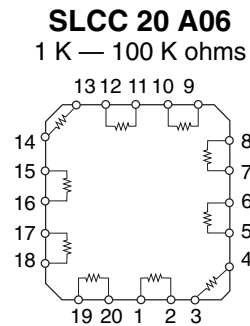
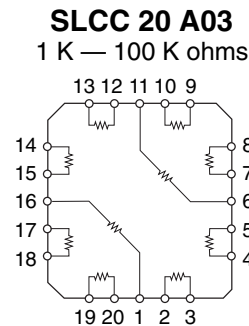
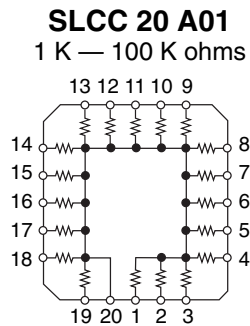
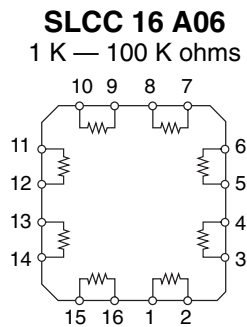
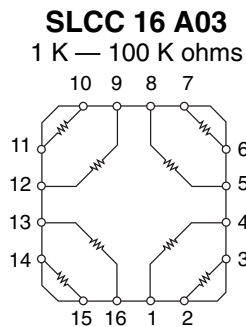
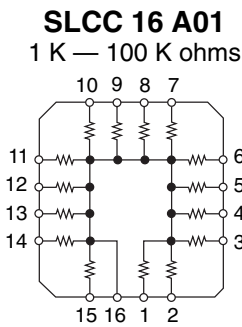

STANDARD ELECTRICAL SPECIFICATIONS			
TEST		SPECIFICATIONS	CONDITIONS
PIN NUMBER		16, 20, 24	
TCR:	Tracking	$\pm 2$ ppm/ $^{\circ}\text{C}$ (typical)/5 ppm/ $^{\circ}\text{C}$ Max.	- 55 $^{\circ}\text{C}$ to + 125 $^{\circ}\text{C}$
	Absolute	$\pm 25$ ppm/ $^{\circ}\text{C}$ Max.	- 55 $^{\circ}\text{C}$ to + 125 $^{\circ}\text{C}$
Tolerance:	Ratio	$\pm 0.1\%$ to 1.0 % tighter specs on request	
	Absolute	$\pm 0.1\%$ to 5.0 % tighter specs on request	
Power Rating:	Resistor	50 mW	at + 70 $^{\circ}\text{C}$
	Package	250 mW 500 mW 1 W	at + 70 $^{\circ}\text{C}$
Stability ( $\Delta R$ Ratio)		0.05 %	1000 hrs at + 70 $^{\circ}\text{C}$ under Pn
Voltage Coefficient		< 0.1 ppm/V	
Working Voltage		100 V <sub>DC</sub> on R	
Operating Temperature Range		- 55 $^{\circ}\text{C}$ to + 125 $^{\circ}\text{C}$	
Storage Temperature Range		- 55 $^{\circ}\text{C}$ to + 150 $^{\circ}\text{C}$	
Noise		- 35 dB typical	
Thermal EMF		0.1 $\mu\text{V}/^{\circ}\text{C}$	
Shelf Life Stability		< 50 ppm	1 year at + 25 $^{\circ}\text{C}$

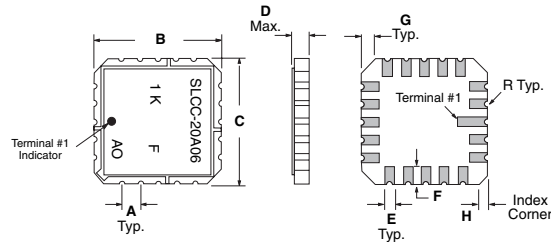
**DIMENSIONS** in inches and millimeters

	A	B	C	D	E	F	G	H
16 Pin	0.050"	0.300"	0.300"	0.077"	0.025"	0.050"	0.040"	0.020"
mm	1.27	7.62	7.62	1.96	0.635	1.27	1.02	0.508
20 Pin	0.050"	0.350"	0.350"	0.077"	0.025"	0.050"	0.040"	0.020"
mm	1.27	8.89	8.89	1.96	0.635	1.27	1.02	0.508
24 Pin	0.050"	0.400"	0.400"	0.077"	0.025"	0.050"	0.040"	0.020"
mm	1.27	10.16	10.16	1.96	0.635	1.27	1.02	0.508

**GLOBAL PART NUMBER INFORMATION**

New Global Part Numbering: SLCC24A01-10KF0005

S	L	C	C	2	4	A	0	1	-	1	0	K	F	0	0	0	5
---	---	---	---	---	---	---	---	---	---	---	---	---	---	---	---	---	---

GLOBAL MODEL SLCC16 SLCC20 SLCC24	SCHEMATIC A B A01 A03 A06	VALUE Decimal R, K or M	TOL. B (0.1 % 0.1 %) D (0.5 % 0.25 %) F (1.0 % 0.5 %) G (2.0 % 1.0 %) J (5.0 % 1.0 %)	SPECIAL
--	--	-------------------------------	--	---------

Historical Part Number example: SLCC 24 A01 10K F R0005 e4



## Notice

Specifications of the products displayed herein are subject to change without notice. Vishay Intertechnology, Inc., or anyone on its behalf, assumes no responsibility or liability for any errors or inaccuracies.

Information contained herein is intended to provide a product description only. No license, express or implied, by estoppel or otherwise, to any intellectual property rights is granted by this document. Except as provided in Vishay's terms and conditions of sale for such products, Vishay assumes no liability whatsoever, and disclaims any express or implied warranty, relating to sale and/or use of Vishay products including liability or warranties relating to fitness for a particular purpose, merchantability, or infringement of any patent, copyright, or other intellectual property right.

The products shown herein are not designed for use in medical, life-saving, or life-sustaining applications. Customers using or selling these products for use in such applications do so at their own risk and agree to fully indemnify Vishay for any damages resulting from such improper use or sale.