

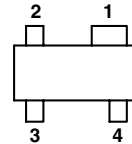

N-Channel Dual Gate MOS-Fieldeffect Tetrode, Depletion Mode

Features

- Integrated gate protection diodes
- Low noise figure
- Low feedback capacitance
- High cross modulation performance
- Low input capacitance
- High AGC-range
- High gain
- Lead (Pb)-free component
- Component in accordance to RoHS 2002/95/EC and WEEE 2002/96/EC



SOT143

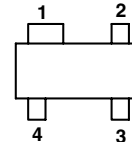
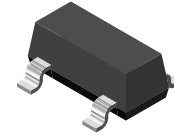

SOT143R

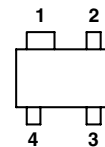
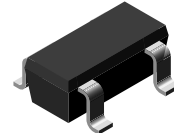

SOT343R

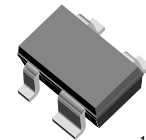

19216



Electrostatic sensitive device.
Observe precautions for handling.

Applications

- Input and mixer stages in UHF tuners

Mechanical Data

Typ: BF998

Case: SOT143 Plastic case

Weight: approx. 8.0 mg

Marking: MO

Pinning:

1 = Source, 2 = Drain,

3 = Gate 2, 4 = Gate 1

Typ: BF998R

Case: SOT143R Plastic case

Weight: approx. 8.0 mg

Marking: MOR

Pinning:

1 = Source, 2 = Drain,

3 = Gate 2, 4 = Gate 1

Typ: BF998RW

Case: SOT343R Plastic case

Weight: approx. 6.0 mg

Marking: WMO

Pinning:

1 = Source, 2 = Drain,

3 = Gate 2, 4 = Gate 1

Parts Table

Part	Ordering code	Type Marking	Remarks
BF998	BF998A-GS08	MO	SOT143
BF998A	BF998A-GS08	MO	SOT143
BF998R	BF998RA-GS08	MOR	SOT143R
BF998RA	BF998RA-GS08	MOR	SOT143R
BF998RW	BF998RAW-GS08 or BF998RBW-GS08	WMO	SOT343R
BF998RAW	BF998RAW-GS08	WMO	SOT343R
BF998RBW	BF998RBW-GS08	WMO	SOT343R

Absolute Maximum Ratings

$T_{amb} = 25\text{ }^{\circ}\text{C}$, unless otherwise specified

Parameter	Test condition	Symbol	Value	Unit
Drain - source voltage		V_{DS}	12	V
Drain current		I_D	30	mA
Gate 1/Gate 2 - source peak current		$\pm I_{G1/G2SM}$	10	mA
Gate 1/Gate 2 - source voltage		$\pm V_{G1S/G2S}$	7	V
Total power dissipation	$T_{amb} \leq 60\text{ }^{\circ}\text{C}$	P_{tot}	200	mW
Channel temperature		T_{Ch}	150	$^{\circ}\text{C}$
Storage temperature range		T_{stg}	- 65 to + 150	$^{\circ}\text{C}$

Thermal Characteristics

Parameter	Test condition	Symbol	Value	Unit
Channel ambient	1)	R_{thChA}	450	K/W

1) on glass fibre printed board (25 x 20 x 1.5) mm³ plated with 35 μm Cu

Electrical DC Characteristics

$T_{amb} = 25\text{ }^{\circ}\text{C}$, unless otherwise specified

Parameter	Test condition	Part	Symbol	Min.	Typ.	Max.	Unit
Drain - source breakdown voltage	$I_D = 10\text{ }\mu\text{A}$, $-V_{G1S} = -V_{G2S} = 4\text{ V}$		$V_{(BR)DS}$	12			V
Gate 1 - source breakdown voltage	$\pm I_{G1S} = 10\text{ mA}$, $V_{G2S} = V_{DS} = 0$		$\pm V_{(BR)G1SS}$	7		14	V
Gate 2 - source breakdown voltage	$\pm I_{G2S} = 10\text{ mA}$, $V_{G1S} = V_{DS} = 0$		$\pm V_{(BR)G2SS}$	7		14	V
Gate 1 - source leakage current	$\pm V_{G1S} = 5\text{ V}$, $V_{G2S} = V_{DS} = 0$		$\pm I_{G1SS}$			50	nA
Gate 2 - source leakage current	$\pm V_{G2S} = 5\text{ V}$, $V_{G1S} = V_{DS} = 0$		$\pm I_{G2SS}$			50	nA
Drain current	$V_{DS} = 8\text{ V}$, $V_{G1S} = 0$, $V_{G2S} = 4\text{ V}$	BF998/ BF998R/ BF998RW	I_{DSS}	4		18	mA
		BF998A/ BF998RA/ BF998RAW	I_{DSS}	4		10.5	mA
		BF998RBW	I_{DSS}	9.5		18	mA
Gate 1 - source cut-off voltage	$V_{DS} = 8\text{ V}$, $V_{G2S} = 4\text{ V}$, $I_D = 20\text{ }\mu\text{A}$		$-V_{G1S(OFF)}$		1.0	2.0	V
Gate 2 - source cut-off voltage	$V_{DS} = 8\text{ V}$, $V_{G1S} = 0$, $I_D = 20\text{ }\mu\text{A}$		$-V_{G2S(OFF)}$		0.6	1.0	V

Electrical AC Characteristics

$T_{amb} = 25\text{ }^{\circ}\text{C}$, unless otherwise specified

$V_{DS} = 8\text{ V}$, $I_D = 10\text{ mA}$, $V_{G2S} = 4\text{ V}$, $f = 1\text{ MHz}$

Parameter	Test condition	Symbol	Min.	Typ.	Max.	Unit
Forward transadmittance		$ y_{21s} $	21	24		mS
Gate 1 input capacitance		C_{issg1}		2.1	2.5	pF
Gate 2 input capacitance	$V_{G1S} = 0$, $V_{G2S} = 4\text{ V}$	C_{issg2}		1.1		pF
Feedback capacitance		C_{rss}		25		fF
Output capacitance		C_{oss}		1.05		pF



Parameter	Test condition	Symbol	Min.	Typ.	Max.	Unit
Power gain	$G_S = 2 \text{ mS}, G_L = 0.5 \text{ mS}, f = 200 \text{ MHz}$	G_{ps}		28		dB
	$G_S = 3,3 \text{ mS}, G_L = 1 \text{ mS}, f = 800 \text{ MHz}$	G_{ps}	16.5	20		dB
AGC range	$V_{G2S} = 4 \text{ to } -2 \text{ V}, f = 800 \text{ MHz}$	ΔG_{ps}	40			dB
Noise figure	$G_S = 2 \text{ mS}, G_L = 0.5 \text{ mS}, f = 200 \text{ MHz}$	F		1.0		dB
	$G_S = 3,3 \text{ mS}, G_L = 1 \text{ mS}, f = 800 \text{ MHz}$	F		1.5		dB

Common Source S-Parameters

$T_{amb} = 25 \text{ }^\circ\text{C}$, unless otherwise specified

$V_{DS} = 8 \text{ V}, V_{G2S} = 4 \text{ V}, Z_0 = 50 \text{ } \Omega$

ID/mA	f/MHz	S11		S21		S12		S22	
		LOG MAG	ANG	LOG MAG	ANG	LOG MAG	ANG	LOG MAG	ANG
			deg		deg		deg		deg
5	100	-0.03	-7.2	5.71	168.8	-55.94	83.6	-0.08	-3.6
	200	-0.15	-14.1	5.51	157.3	-50.26	76.8	-0.13	-7.0
	300	-0.34	-20.9	5.20	134.7	-48.51	67.7	-0.29	-9.7
	400	-0.70	-32.1	2.01	121.3	-46.98	62.8	-0.44	-12.3
	500	-1.03	-39.2	1.45	108.4	-46.40	57.8	-0.59	-15.1
	600	-1.33	-45.8	0.94	96.5	-46.40	57.3	-0.76	-17.4
	700	-1.62	-52.3	0.43	85.0	-47.02	58.9	-0.91	-19.7
	800	-1.92	-58.7	-0.10	74.1	-47.53	63.3	-1.08	-22.0
	900	-2.21	-64.7	-0.59	63.6	-47.81	73.1	-1.26	-24.3
	1000	-2.49	-70.7	-1.12	53.1	-48.52	83.5	-1.45	-26.2
	1100	-2.80	-76.6	-1.52	43.7	-48.53	102.1	-1.57	-28.4
1200	-3.07	-82.5	-1.93	33.6	-46.95	120.4	-1.75	-30.5	
1300	-3.31	-88.6	-2.35	24.1	-44.44	131.7	-1.92	-32.7	
10	100	-0.05	-9.0	5.19	165.3	-56.24	81.9	-0.11	-3.5
	200	-0.16	-18.7	5.58	151.8	-49.97	75.0	-0.21	-7.2
	300	-0.48	-26.0	4.45	136.3	-47.91	67.2	-0.33	-9.8
	400	-0.76	-33.7	3.95	123.3	-46.48	61.8	-0.47	-12.6
	500	-1.11	-41.2	3.40	110.9	-45.91	56.3	-0.65	-15.3
	600	-1.43	-48.3	2.88	99.5	-45.91	55.8	-0.81	-17.8
	700	-1.75	-55.1	2.39	88.7	-46.53	56.7	-0.96	-20.0
	800	-2.07	-61.6	1.88	78.1	-47.13	60.7	-1.12	-22.4
	900	-2.40	-67.9	1.39	67.9	-47.41	69.9	-1.32	-24.6
	1000	-2.70	-74.2	0.90	57.9	-48.21	80.0	-1.49	-26.6
	1100	-3.03	-80.2	0.50	48.7	-48.43	98.9	-1.61	-28.8
	1200	-3.32	-86.4	0.13	38.9	-47.04	118.2	-1.79	-31.0
	1300	-3.59	-92.3	-0.28	29.6	-44.54	130.5	-1.96	-33.3
15	100	-0.05	-9.4	6.07	165.4	-55.74	81.4	-0.15	-3.6
	200	-0.17	-19.4	6.44	152.0	-49.47	74.6	-0.24	-7.3
	300	-0.50	-27.1	5.31	136.7	-47.41	66.4	-0.36	-10.0
	400	-0.81	-35.0	4.80	123.8	-45.98	60.8	-0.52	-12.9
	500	-1.18	-42.9	4.23	111.5	-45.41	55.1	-0.68	-15.7
	600	-1.52	-50.3	3.72	100.3	-45.41	54.4	-0.84	-18.0
	700	-1.86	-57.2	3.22	89.6	-46.13	54.9	-1.02	-20.4
	800	-2.20	-63.9	2.72	79.4	-46.63	58.5	-1.16	-22.7
	900	-2.53	-70.4	2.24	69.2	-47.00	67.3	-1.35	-25.0
	1000	-2.86	-76.8	1.74	59.4	-47.91	76.7	-1.53	-27.1
	1100	-3.21	-82.9	1.34	50.2	-48.33	95.2	-1.66	-29.4
	1200	-3.50	-89.0	0.95	40.8	-47.04	115.3	-1.84	-31.6
	1300	-3.80	-95.1	0.56	31.5	-44.53	128.7	-2.00	-33.9

Typical Characteristics

$T_{amb} = 25\text{ }^{\circ}\text{C}$, unless otherwise specified

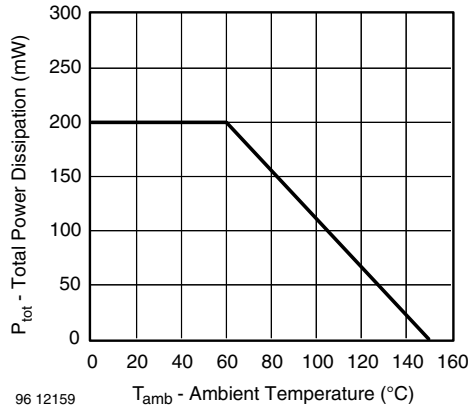

Figure 1. Total Power Dissipation vs. Ambient Temperature

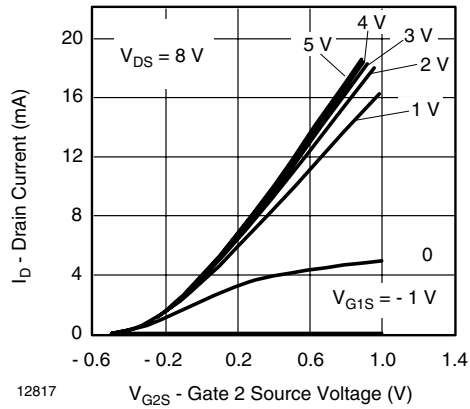

Figure 4. Drain Current vs. Gate 2 Source Voltage

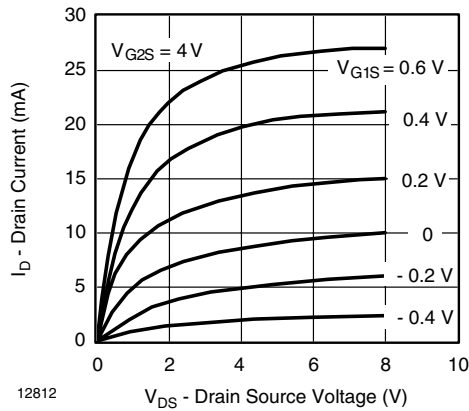

Figure 2. Drain Current vs. Drain Source Voltage

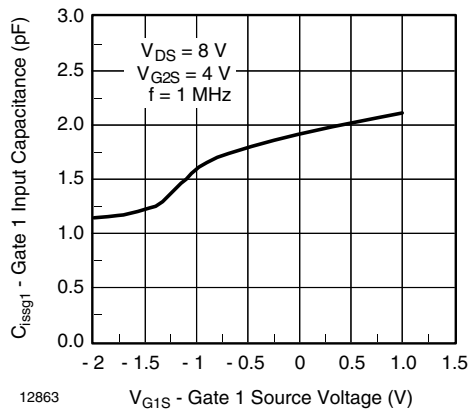

Figure 5. Gate 1 Input Capacitance vs. Gate 1 Source Voltage

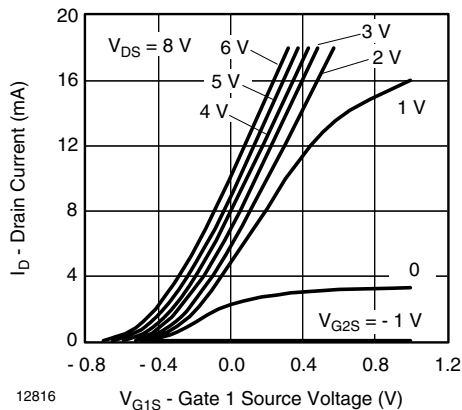

Figure 3. Drain Current vs. Gate 1 Source Voltage

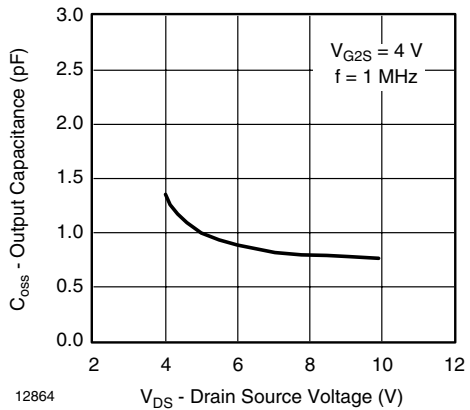

Figure 6. Output Capacitance vs. Drain Source Voltage

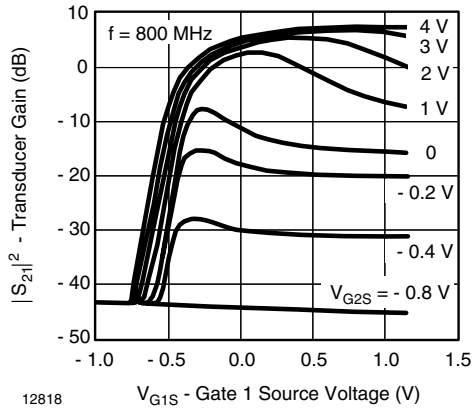

Figure 7. Transducer Gain vs. Gate 1 Source Voltage

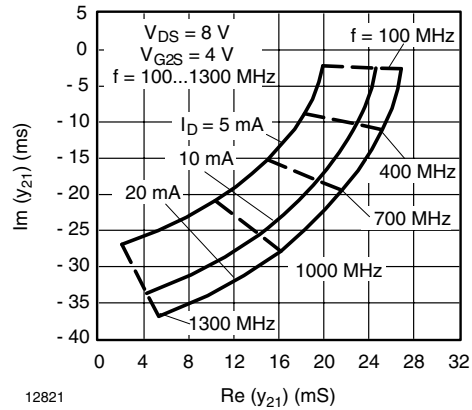

Figure 10. Short Circuit Forward Transfer Admittance

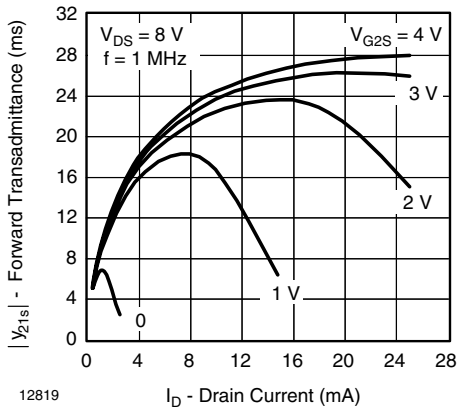

Figure 8. Forward Transadmittance vs. Drain Current

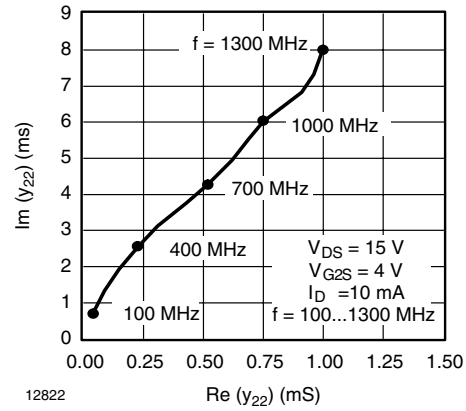

Figure 11. Short Circuit Output Admittance

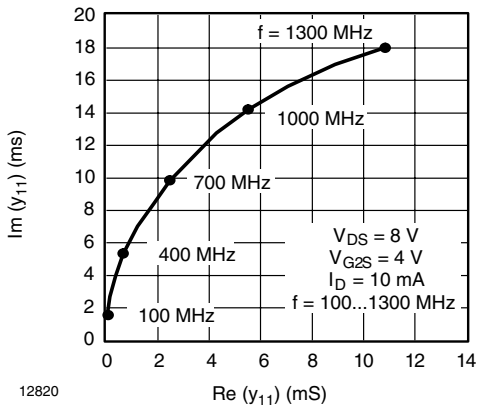

Figure 9. Short Circuit Input Admittance

Vishay Semiconductors

$V_{DS} = 8\text{ V}$, $I_D = 10\text{ mA}$, $V_{G2S} = 4\text{ V}$, $Z_0 = 50\ \Omega$

S_{11}

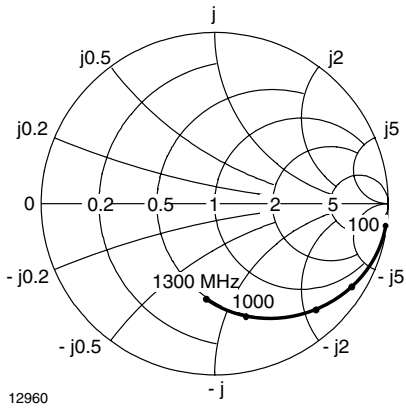

Figure 12. Input Reflection Coefficient

S_{21}

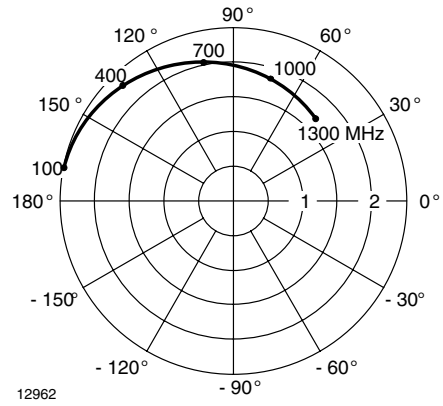

Figure 14. Forward Transmission Coefficient

S_{12}

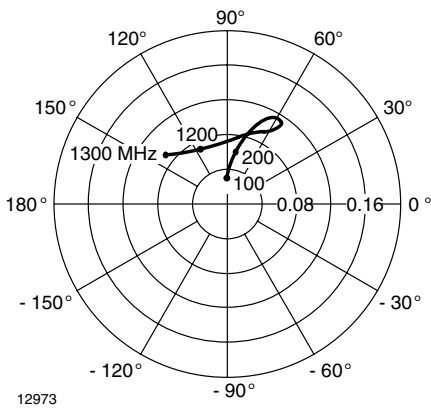

Figure 13. Reverse Transmission Coefficient

S_{22}

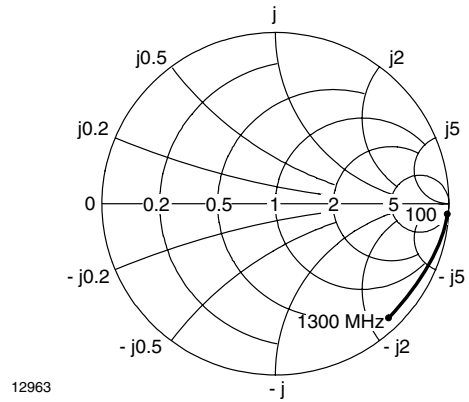
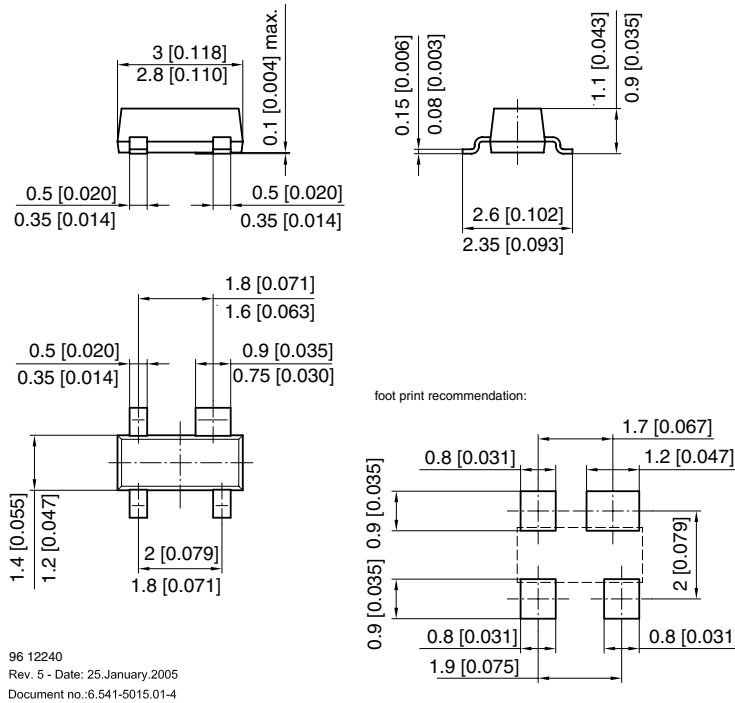

Figure 15. Output Reflection Coefficient



Package Dimensions in millimeters (inches): SOT143



Package Dimensions in millimeters (inches): SOT143R

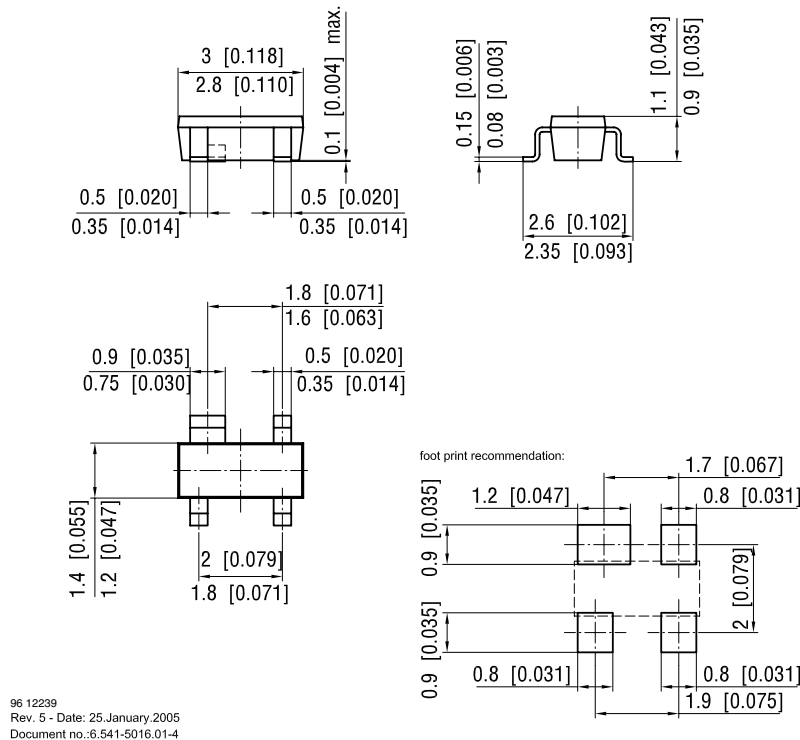

BF998/BF998R/BF998RW



Vishay Semiconductors

Package Dimensions in millimeters (inches): SOT343R

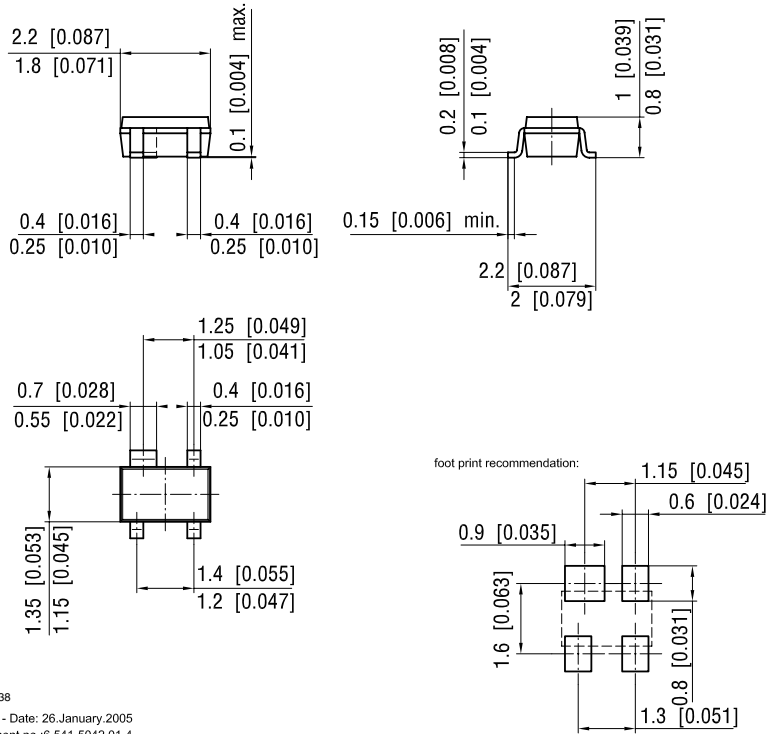

96 12238
Rev. 4 - Date: 26 January 2005
Document no.: 6.541-5042.01-4



Ozone Depleting Substances Policy Statement

It is the policy of Vishay Semiconductor GmbH to

1. Meet all present and future national and international statutory requirements.
2. Regularly and continuously improve the performance of our products, processes, distribution and operating systems with respect to their impact on the health and safety of our employees and the public, as well as their impact on the environment.

It is particular concern to control or eliminate releases of those substances into the atmosphere which are known as ozone depleting substances (ODSs).

The Montreal Protocol (1987) and its London Amendments (1990) intend to severely restrict the use of ODSs and forbid their use within the next ten years. Various national and international initiatives are pressing for an earlier ban on these substances.

Vishay Semiconductor GmbH has been able to use its policy of continuous improvements to eliminate the use of ODSs listed in the following documents.

1. Annex A, B and list of transitional substances of the Montreal Protocol and the London Amendments respectively
2. Class I and II ozone depleting substances in the Clean Air Act Amendments of 1990 by the Environmental Protection Agency (EPA) in the USA
3. Council Decision 88/540/EEC and 91/690/EEC Annex A, B and C (transitional substances) respectively.

Vishay Semiconductor GmbH can certify that our semiconductors are not manufactured with ozone depleting substances and do not contain such substances.

We reserve the right to make changes to improve technical design
and may do so without further notice.

Parameters can vary in different applications. All operating parameters must be validated for each customer application by the customer. Should the buyer use Vishay Semiconductors products for any unintended or unauthorized application, the buyer shall indemnify Vishay Semiconductors against all claims, costs, damages, and expenses, arising out of, directly or indirectly, any claim of personal damage, injury or death associated with such unintended or unauthorized use.

Vishay Semiconductor GmbH, P.O.B. 3535, D-74025 Heilbronn, Germany



Disclaimer

All product specifications and data are subject to change without notice.

Vishay Intertechnology, Inc., its affiliates, agents, and employees, and all persons acting on its or their behalf (collectively, "Vishay"), disclaim any and all liability for any errors, inaccuracies or incompleteness contained herein or in any other disclosure relating to any product.

Vishay disclaims any and all liability arising out of the use or application of any product described herein or of any information provided herein to the maximum extent permitted by law. The product specifications do not expand or otherwise modify Vishay's terms and conditions of purchase, including but not limited to the warranty expressed therein, which apply to these products.

No license, express or implied, by estoppel or otherwise, to any intellectual property rights is granted by this document or by any conduct of Vishay.

The products shown herein are not designed for use in medical, life-saving, or life-sustaining applications unless otherwise expressly indicated. Customers using or selling Vishay products not expressly indicated for use in such applications do so entirely at their own risk and agree to fully indemnify Vishay for any damages arising or resulting from such use or sale. Please contact authorized Vishay personnel to obtain written terms and conditions regarding products designed for such applications.

Product names and markings noted herein may be trademarks of their respective owners.