

Optocoupler, Phototriac Output, Zero Crossing, High dV/dt, Very Low Input Current

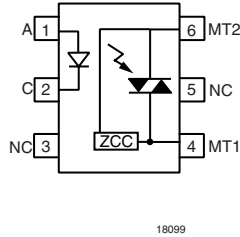
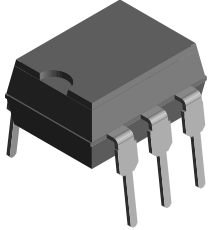

18099

DESCRIPTION

The IL4116/IL4117/IL4118 consists of an AlGaAs IRLED optically coupled to a photosensitive zero crossing TRIAC network. The TRIAC consists of two inverse parallel connected monolithic SCRs. These three semiconductor devices are assembled in a six pin 300 mil dual in-line package.

High input sensitivity is achieved by using an emitter follower phototransistor and a cascaded SCR predriver resulting in an LED trigger current of less than 1.3 mA (DC).

The IL4116/IL4117/IL4118 uses zero cross line voltage detection circuit which consists of two enhancement MOSFETs and a photodiode. The inhibit voltage of the network is determined by the enhancement voltage of the N-channel FET. The P-channel FET is enabled by a photocurrent source that permits the FET to conduct the main voltage to gate on the N-channel FET. Once the main voltage can enable the N-channel, it clamps the base of the phototransistor, disabling the first stage SCR predriver.

The blocking voltage of up to 800 V permits control of off-line voltages up to 240 VAC, with a safety factor of more than two, and is sufficient for as much as 380 VAC. Current handling capability is up to 300 mA RMS continuous at 25 °C.

The IL4116/IL4117/IL4118 isolates low-voltage logic from 120, 240, and 380 VAC lines to control resistive, inductive, or capacitive loads including motors, solenoids, high current thyristors or TRIAC and relays.

Applications include solid-state relays, industrial controls, office equipment, and consumer appliances.

FEATURES

- High input sensitivity: $I_{FT} = 1.3 \text{ mA}$, $PF = 1.0$; $I_{FT} = 3.5 \text{ mA}$, typical $PF < 1.0$
- Zero voltage crossing
- 600/700/800 V blocking voltage
- 300 mA on-state current
- High dV/dt 10000 V/μs
- Inverse parallel SCRs provide commutating dV/dt > 10 kV/μs
- Isolation test voltage 5300 V_{RMS}
- Very low leakage < 10 μA
- Lead (Pb)-free component
- Component in accordance to RoHS 2002/95/EC and WEEE 2002/96/EC

RoHS
COMPLIANT

APPLICATIONS

- Solid state relay
- Lighting controls
- Temperature controls
- Solenoid/valve controls
- AC motor drives/starters

AGENCY APPROVALS

- UL1577, file no. E52744 system code H or J, double protection
- CSA 93751
- BSI IEC 60950 IEC 60065
- DIN EN 60747-5-2 (VDE 0884)/DIN EN 60747-5-5 pending available with option 1
- FIMKO

ORDER INFORMATION

PART	REMARKS
IL4116	600 V V _{DRM} , DIP-6
IL4117	700 V V _{DRM} , DIP-6
IL4118	800 V V _{DRM} , DIP-6
IL4116-X006	600 V V _{DRM} , DIP-6 400 mil (option 6)
IL4116-X007	600 V V _{DRM} , SMD-6 (option 7)
IL4116-X009	600 V V _{DRM} , SMD-6(option 9)
IL4117-X007	700 V V _{DRM} , SMD-6 (option 7)
IL4118-X006	800 V V _{DRM} , DIP-6 400 mil (option 6)

ORDER INFORMATION	
PART	REMARKS
IL4118-X007	800 V V_{DRM} , SMD-6 (option 7)
IL4118-X009	800 V V_{DRM} , SMD-6 (option 9)

Note

For additional information on the available options refer to option information.

ABSOLUTE MAXIMUM RATINGS ⁽¹⁾					
PARAMETER	TEST CONDITION	PART	SYMBOL	VALUE	UNIT
INPUT					
Reverse voltage			V_R	6.0	V
Forward current			I_F	60	mA
Surge current			I_{FSM}	2.5	A
Power dissipation			P_{diss}	100	mW
Derate linearly from 25 °C				1.33	mW/°C
Thermal resistance			R_{th}	750	°C/W
OUTPUT					
Peak off-state voltage		IL4116	V_{DRM}	600	V
		IL4117	V_{DRM}	700	V
		IL4118	V_{DRM}	800	V
RMS on-state current			I_{DRM}	300	mA
Single cycle surge				3.0	A
Power dissipation			P_{diss}	500	mW
Derate linearly from 25 °C				6.6	mW/°C
Thermal resistance			R_{th}	150	°C/W
COUPLER					
Creepage distance				≥ 7.0	mm
Clearance distance				≥ 7.0	mm
Storage temperature			T_{stg}	- 55 to + 150	°C
Operating temperature			T_{amb}	- 55 to + 100	°C
Isolation test voltage			V_{IO}	5300	V_{RMS}
Isolation resistance	$V_{IO} = 500\text{ V}, T_{amb} = 25\text{ °C}$		R_{IO}	≥ 10^{12}	Ω
	$V_{IO} = 500\text{ V}, T_{amb} = 100\text{ °C}$		R_{IO}	≥ 10^{11}	Ω
Lead soldering temperature ⁽²⁾	5 s		T_{sld}	260	°C

Notes

⁽¹⁾ $T_{amb} = 25\text{ °C}$, unless otherwise specified

Stresses in excess of the absolute maximum ratings can cause permanent damage to the device. Functional operation of the device is not implied at these or any other conditions in excess of those given in the operational sections of this document. Exposure to absolute maximum ratings for extended periods of the time can adversely affect reliability.

⁽²⁾ Refer to reflow profile for soldering conditions for surface mounted devices (SMD). Refer to wave profile for soldering conditions for through hole devices (DIP).



Optocoupler, Phototriac Output, Vishay Semiconductors
Zero Crossing, High dV/dt, Very Low
Input Current

ELECTRICAL CHARACTERISTICS							
PARAMETER	TEST CONDITION	PART	SYMBOL	MIN.	TYP.	MAX.	UNIT
INPUT							
Forward voltage	$I_F = 20 \text{ mA}$		V_F		1.3	1.5	V
Breakdown voltage	$I_R = 10 \text{ }\mu\text{A}$		V_{BR}	6.0	30		V
Reverse current	$V_R = 6.0 \text{ V}$		I_R		0.1	10	μA
Capacitance	$V_F = 0 \text{ V}, f = 1.0 \text{ MHz}$		C_O		40		pF
Thermal resistance, junction to lead			R_{thjl}		750		$^\circ\text{C/W}$
OUTPUT							
Repetitive peak off-state voltage	$I_{DRM} = 100 \text{ }\mu\text{A}$	IL4116	V_{DRM}	600	650		V
		IL4117	V_{DRM}	700	750		V
		IL4118	V_{DRM}	800	850		V
Off-state voltage	$I_{D(RMS)} = 70 \text{ }\mu\text{A}$	IL4116	$V_{D(RMS)}$	424	460		V
		IL4117	$V_{D(RMS)}$	494	536		V
		IL4118	$V_{D(RMS)}$	565	613		V
Off-state current	$V_D = 600, T_{amb} = 100 \text{ }^\circ\text{C}$		$I_{D(RMS)}$		10	100	μA
On-state voltage	$I_T = 300 \text{ mA}$		V_{TM}		1.7	3.0	V
On-state current	$PF = 1.0, V_{T(RMS)} = 1.7 \text{ V}$		I_{TM}			300	mA
Surge (non-repetitive, on-state current)	$f = 50 \text{ Hz}$		I_{TSM}			3.0	A
Holding current	$V_T = 3.0 \text{ V}$		I_H		65	200	μA
Latching current	$V_T = 2.2 \text{ V}$		I_L		5.0		mA
LED trigger current	$V_{AK} = 5.0 \text{ V}$		I_{FT}		0.7	1.3	mA
Zero cross inhibit voltage	$I_F = \text{rated } I_{FT}$		V_{IH}		15	25	V
Critical rate of rise off-state voltage	$V_{RM}, V_{DM} = 400 \text{ VAC}$		$dV_{(MT)}/dt$	10000			V/ μs
	$V_{RM}, V_{DM} = 400 \text{ VAC}, T_{amb} = 80 \text{ }^\circ\text{C}$		$dV_{(MT)}/dt$		2000		V/ μs
Commutating voltage	$V_{RM}, V_{DM} = 400 \text{ VAC}$		$dV_{(COM)}/dt$	10000			V/ μs
	$V_{RM}, V_{DM} = 400 \text{ VAC}, T_{amb} = 80 \text{ }^\circ\text{C}$		$dV_{(COM)}/dt$		2000		V/ μs
Commutating current	$I_T = 300 \text{ mA}$		dI/dt		100		A/ms
Thermal resistance, junction to lead			R_{thjl}		150		$^\circ\text{C/W}$
COUPLER							
Critical state of rise of coupler input-output voltage	$I_T = 0 \text{ A}, V_{RM} = V_{DM} = 424 \text{ VAC}$		$dV_{(IO)}/dt$	10000			V/ μs
Capacitance (input to output)	$f = 1.0 \text{ MHz}, V_{IO} = 0 \text{ V}$		C_{IO}		0.8		pF
Common mode coupling capacitance			C_{CM}		0.01		pF

Note

$T_{amb} = 25 \text{ }^\circ\text{C}$, unless otherwise specified

Minimum and maximum values are testing requirements. Typical values are characteristics of the device and are the result of engineering evaluation. Typical values are for information only and are not part of the testing requirements.

SWITCHING CHARACTERISTICS							
PARAMETER	TEST CONDITION	PART	SYMBOL	MIN.	TYP.	MAX.	UNIT
Turn-on time	$V_{RM} = V_{DM} = 424 \text{ VAC}$		t_{on}		35		μs
Turn-off time	$PF = 1.0, I_T = 300 \text{ mA}$		t_{off}		50		μs

TYPICAL CHARACTERISTICS

T_{amb} = 25 °C, unless otherwise specified

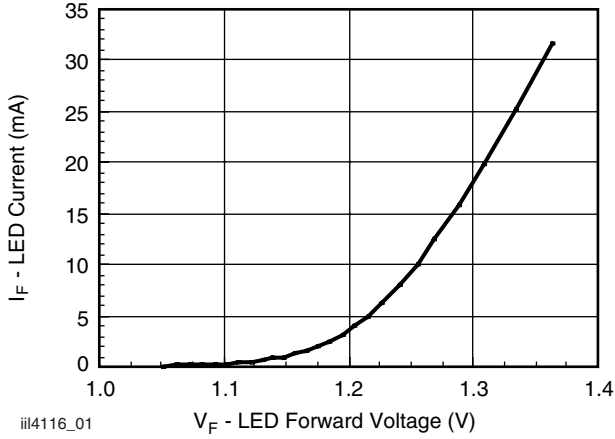

Fig. 1 - LED Forward Current vs. Forward Voltage

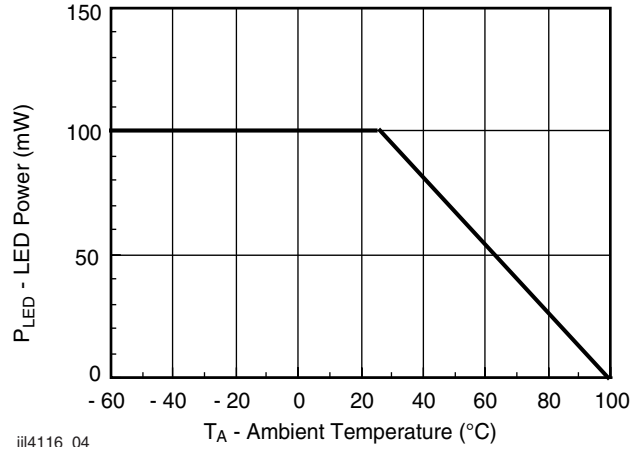

Fig. 4 - Maximum LED Power Dissipation

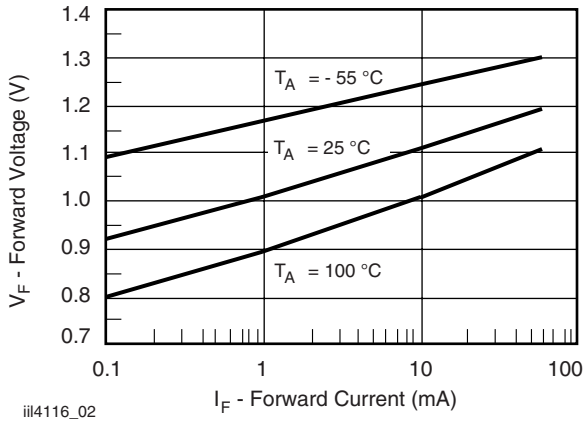

Fig. 2 - Forward Voltage vs. Forward Current

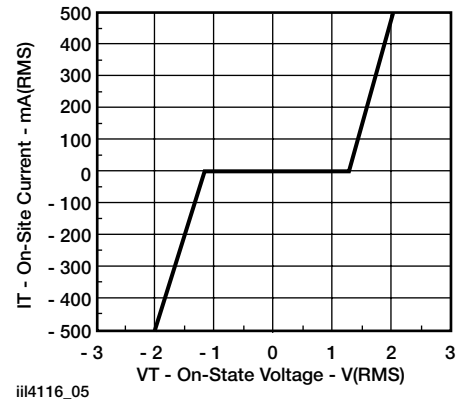

Fig. 5 - On-State Terminal Voltage vs. Terminal Current

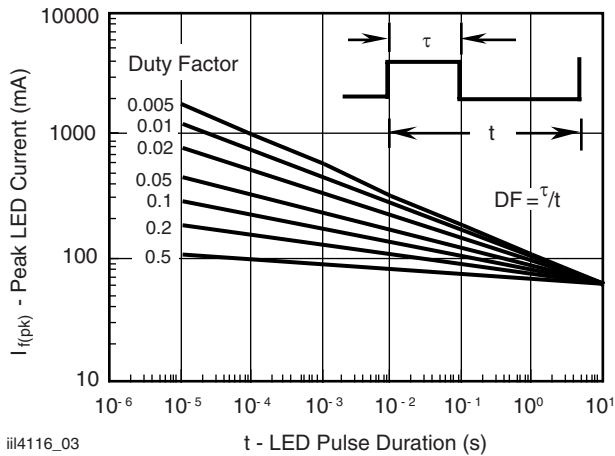

Fig. 3 - Peak LED Current vs. Duty Factor, τ

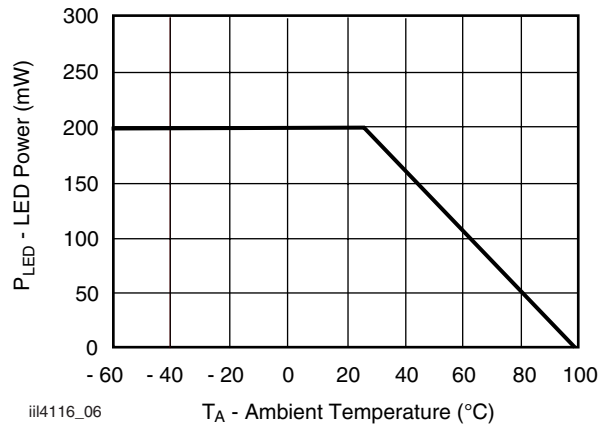

Fig. 6 - Maximum Output Power Dissipation



Power Factor Considerations

A snubber isn't needed to eliminate false operation of the TRIAC driver because of the IL4116/IL4117/IL4118 high static and commutating dV/dt with loads between 1 and 0.8 power factors. When inductive loads with power factors less than 0.8 are being driven, include an RC snubber or a single capacitor directly across the device to damp the peak commutating dV/dt spike. Normally a commutating dV/dt causes a turning-off device to stay on due to the stored energy remaining in the turn-off device.

But in the case of a zero voltage crossing optotriac, the commutating dV/dt spikes can inhibit one half of the TRIAC from turning on. If the spike potential exceeds the inhibit voltage of the zero cross detection circuit, half of the TRIAC will be held-off and not turn-on. This hold-off condition can be eliminated by using a snubber or capacitor placed directly across the optotriac as shown in Figure 7. Note that the value of the capacitor increases as a function of the load current.

The hold-off condition also can be eliminated by providing a higher level of LED drive current. The higher LED drive provides a larger photocurrent which causes the phototransistor to turn-on before the commutating spike has activated the zero cross network. Figure 8 shows the relationship of the LED drive for power factors of less than 1.0. The curve shows that if a device requires 1.5 mA for a resistive load, then 1.8 times (2.7 mA) that amount would be required to control an inductive load whose power factor is less than 0.3.

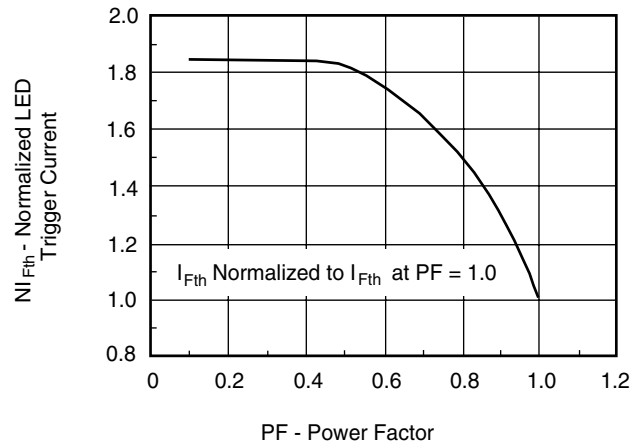

iii4116_08

Fig. 8 - Normalized LED Trigger Current

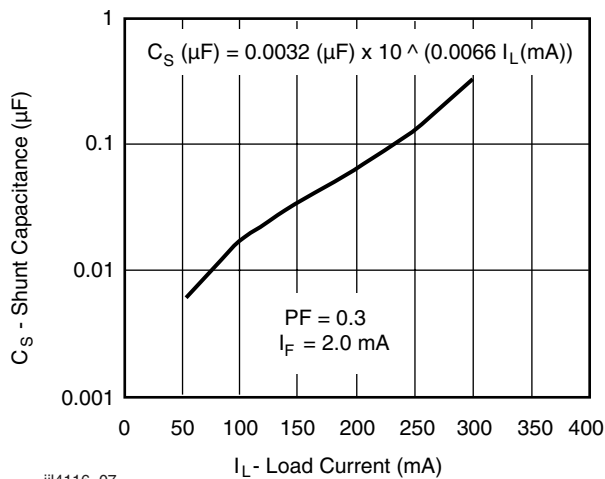

iii4116_07

Fig. 7 - Shunt Capacitance vs. Load Current vs. Power Factor

IL4116/IL4117/IL4118



Vishay Semiconductors Optocoupler, Phototriac Output,
Zero Crossing, High dV/dt, Very Low
Input Current

PACKAGE DIMENSIONS in inches (millimeters)

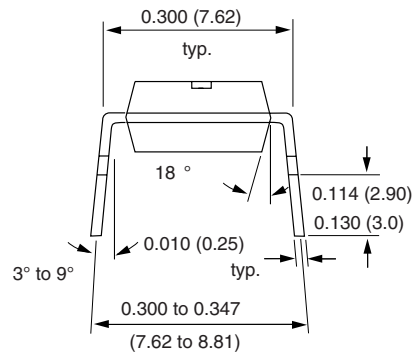
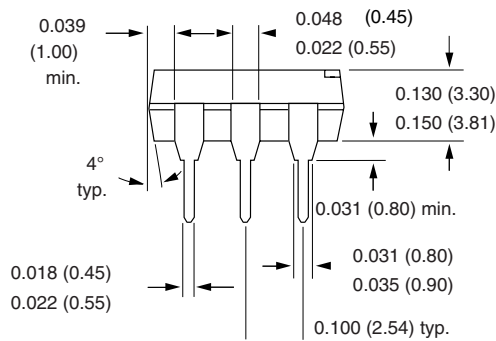
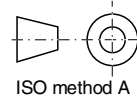
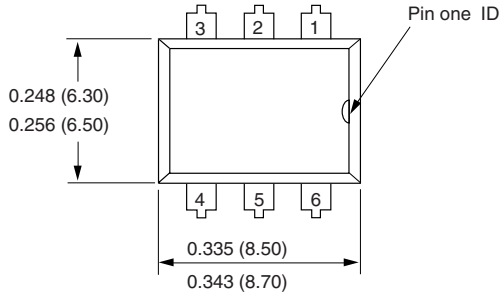

i178004

Option 6

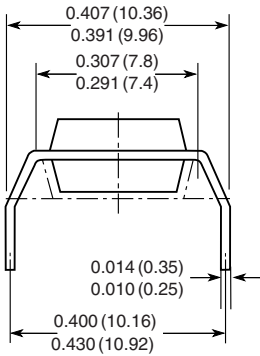

Option 7

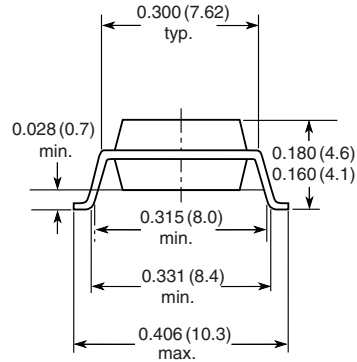

Option 9

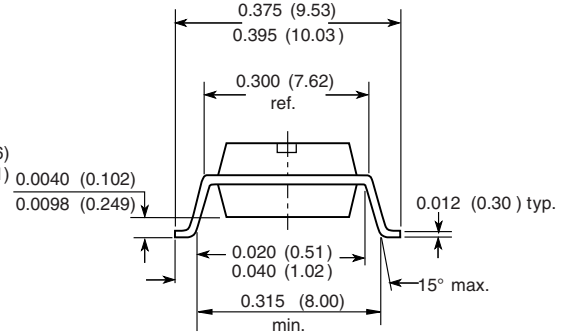

18450



Optocoupler, Phototriac Output,
Zero Crossing, High dV/dt, Very Low
Input Current

Vishay Semiconductors

OZONE DEPLETING SUBSTANCES POLICY STATEMENT

It is the policy of Vishay Semiconductor GmbH to

1. Meet all present and future national and international statutory requirements.
2. Regularly and continuously improve the performance of our products, processes, distribution and operating systems with respect to their impact on the health and safety of our employees and the public, as well as their impact on the environment.

It is particular concern to control or eliminate releases of those substances into the atmosphere which are known as ozone depleting substances (ODSs).

The Montreal Protocol (1987) and its London Amendments (1990) intend to severely restrict the use of ODSs and forbid their use within the next ten years. Various national and international initiatives are pressing for an earlier ban on these substances.

Vishay Semiconductor GmbH has been able to use its policy of continuous improvements to eliminate the use of ODSs listed in the following documents.

1. Annex A, B and list of transitional substances of the Montreal Protocol and the London Amendments respectively.
2. Class I and II ozone depleting substances in the Clean Air Act Amendments of 1990 by the Environmental Protection Agency (EPA) in the USA.
3. Council Decision 88/540/EEC and 91/690/EEC Annex A, B and C (transitional substances) respectively.

Vishay Semiconductor GmbH can certify that our semiconductors are not manufactured with ozone depleting substances and do not contain such substances.

We reserve the right to make changes to improve technical design
and may do so without further notice.

Parameters can vary in different applications. All operating parameters must be validated for each customer application by the customer. Should the buyer use Vishay Semiconductors products for any unintended or unauthorized application, the buyer shall indemnify Vishay Semiconductors against all claims, costs, damages, and expenses, arising out of, directly or indirectly, any claim of personal damage, injury or death associated with such unintended or unauthorized use.

Vishay Semiconductor GmbH, P.O.B. 3535, D-74025 Heilbronn, Germany



Disclaimer

All product specifications and data are subject to change without notice.

Vishay Intertechnology, Inc., its affiliates, agents, and employees, and all persons acting on its or their behalf (collectively, "Vishay"), disclaim any and all liability for any errors, inaccuracies or incompleteness contained herein or in any other disclosure relating to any product.

Vishay disclaims any and all liability arising out of the use or application of any product described herein or of any information provided herein to the maximum extent permitted by law. The product specifications do not expand or otherwise modify Vishay's terms and conditions of purchase, including but not limited to the warranty expressed therein, which apply to these products.

No license, express or implied, by estoppel or otherwise, to any intellectual property rights is granted by this document or by any conduct of Vishay.

The products shown herein are not designed for use in medical, life-saving, or life-sustaining applications unless otherwise expressly indicated. Customers using or selling Vishay products not expressly indicated for use in such applications do so entirely at their own risk and agree to fully indemnify Vishay for any damages arising or resulting from such use or sale. Please contact authorized Vishay personnel to obtain written terms and conditions regarding products designed for such applications.

Product names and markings noted herein may be trademarks of their respective owners.