

Z-Based Bulk Metal® Foil Technology Rapid ΔR Stabilization - Low WCR - Low TCR

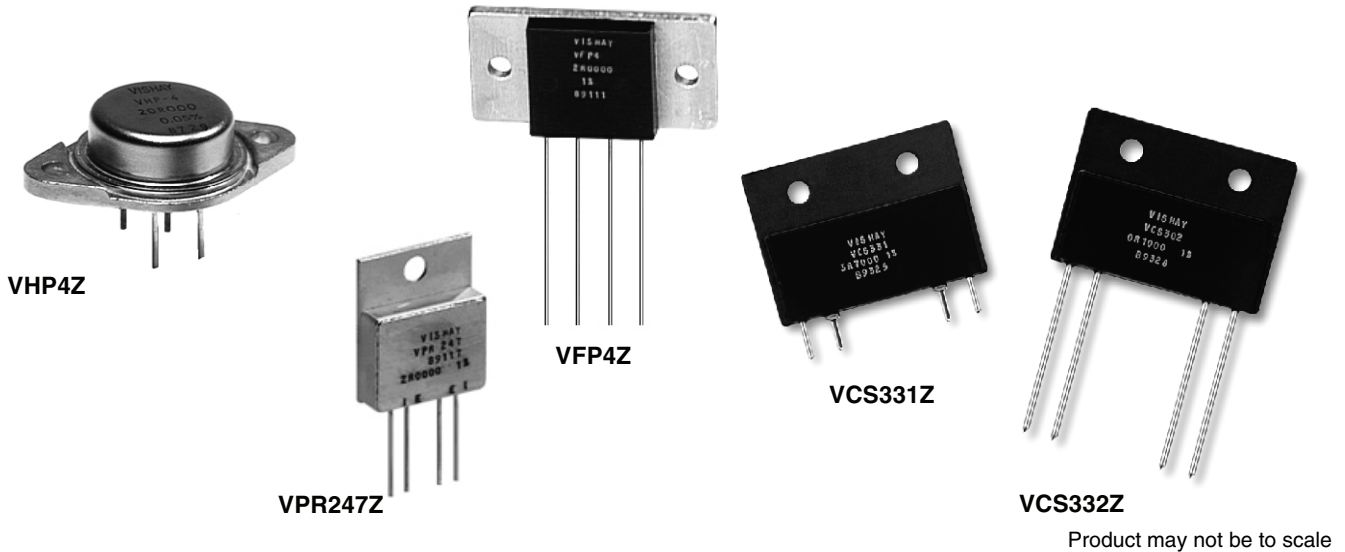

Rapid ΔR stabilization under transient loads, low wattage coefficient (WCR), and low temperature coefficient (TCR) are features of this new Z Based Bulk Metal® Foil series of Current Sense Resistors.

The series should be selected where rapid ΔR stabilization and resistance stability under transient power conditions is required. These products achieve optimum performance when mounted on a chassis or cooled heat sink. The Z Based Technology provides extremely low WCR under defined conditions (see Figure 1 and Figure 2). The low absolute TCR provided by the Z Based Technology is measured over the temperature range of - 55 °C to + 125 °C, + 25 °C reference (see Figure 3).

All of these devices utilizing the Z Based Technology are provided with a true 4 terminal Kelvin connection. This is a must for current sensing when the R-value is less than 100 Ω . The VHP4Z and VPR247Z types add the additional benefit of hermeticity. The welded construction and nitrogen backfill provide maximum protection against environmental stresses and insures long term stability. Typical applications for this new series includes electron beam circuitry, electron microscopes, fire control radar display systems, high speed video display, deflection amplifier circuits, constant current power supplies and forced balance electronic scales.

Custom high power designs can be developed for your specific applications.

SALES

• AMERICAS: foilsales.usa@vishay.com • ASIA/JAPAN: foilsales.asia@vishay.com • UK/HOLLAND/SCANDINAVIA: foilsales.eunorth@vishay.com
• GERMANY/CZECH REPUBLIC/AUSTRIA: foilsales.eucentral@vishay.com • FRANCE/SWITZERLAND/SOUTHERN EUROPE: foilsales.eusouth@vishay.com • ISRAEL: foilsales.israel@vishay.com

FEATURES

- Rapid ΔR Stabilization under transient loads (see Figure 1)
- Tenfold improvement of Wattage Coefficient of Resistance (WCR): 4 ppm/W (see Figure 2)
- Low Temperature Coefficient of Resistance: (see Figure 3 and Table 2)
- Thermal Resistance: 6 °C/W
- Power Rating: 10 watts on heat sink¹⁾ at + 25 °C (see Table 2)
3 watts in free air at + 25 °C (see Table 2)
- Load Life Stability:
 ± 0.05 % Max ΔR , 10 W on heat sink at + 25 °C, 2000 hours
 ± 0.01 % Max ΔR , 3 W on heat sink at + 25 °C, 2000 hours
 ± 0.05 % Max ΔR , 3 W in free air at + 25 °C, 2000 hours
- Current Noise: < 0.01 μV (RMS)/volt of applied voltage
- Thermal EMF: 0.1 $\mu V/^\circ C$ maximum, 0.05 $\mu V/^\circ C$ typical
- Non-Inductive design

NOTE:

- 1.Heatsink - Aluminum (6" L x 4" W x 2" H x 0.04" THK)



Power Current Sense Resistors

Z-Based Bulk Metal® Foil Technology Vishay Foil Resistors
 Rapid ΔR Stabilization - Low WCR - Low TCR

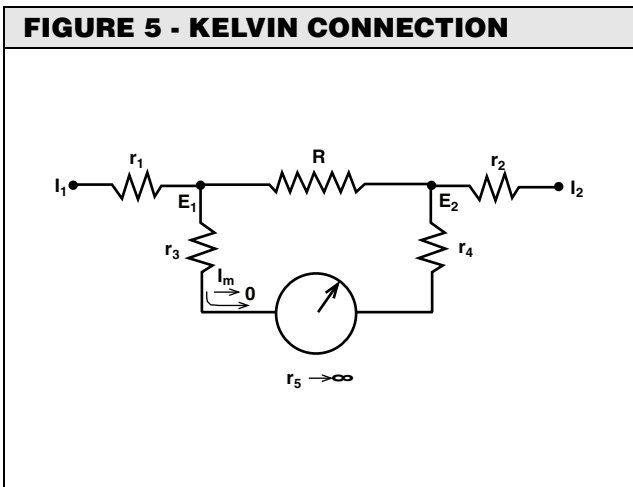
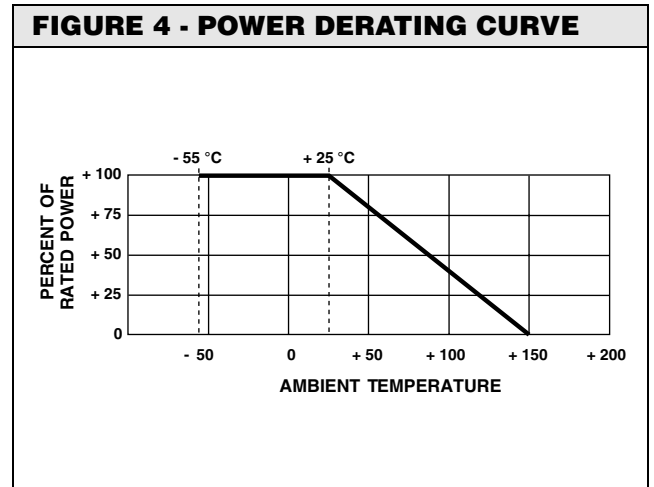
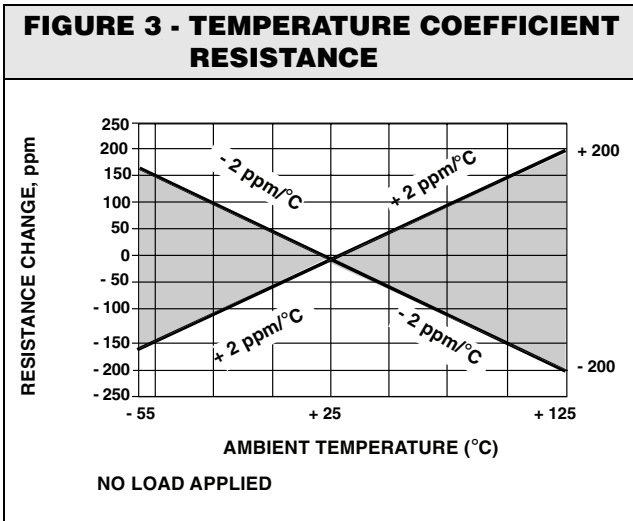
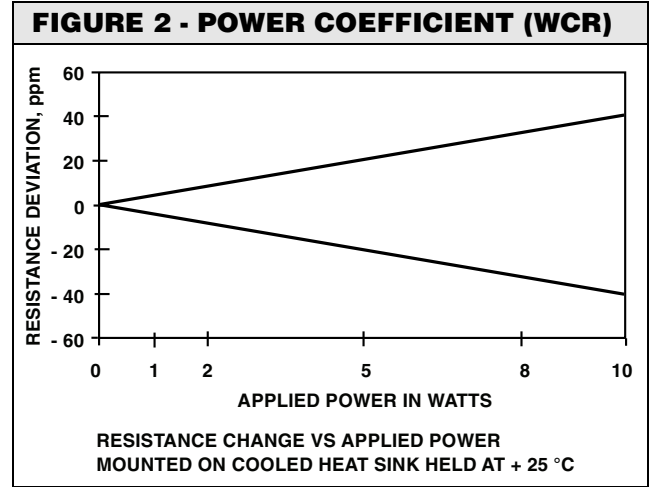
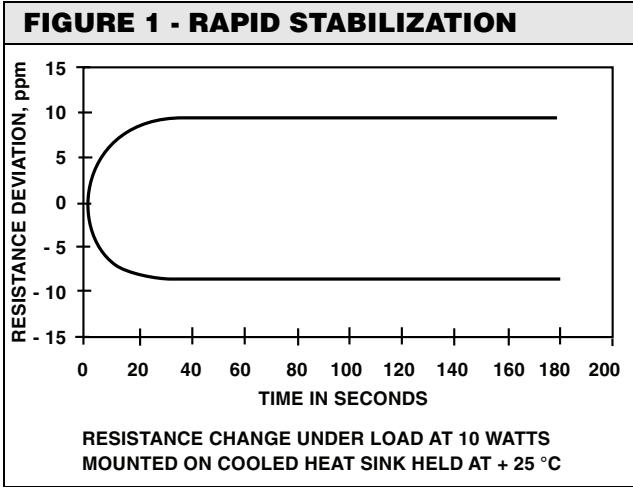

Kelvin, 4-terminal, connections are utilized for these low ohmic value products to measure a precise voltage drop across the resistive element. In these applications the contact resistance, lead resistance, and their TCR effect may be greater than that of the element itself and could cause significant errors if the standard 2-terminal connection is used. Figure 5 shows a high impedance measurement system where r_5 approaches infinity and I_m approaches zero resulting in negligible IR drop through r_3 and r_4 which negates their lead resistance and TCR effect. With the voltage sense leads E_1 and E_2 inside of r_1 and r_2 the resistance and TCR effect of the current leads, I_1 and I_2 are negated and only the resistance and TCR of the element R are sensed. This method of measurement is essential for precise current sensing.

SALES

- AMERICAS: foilsales.usa@vishay.com
- ASIA/JAPAN: foilsales.asia@vishay.com
- UK/HOLLAND/SCANDINAVIA: foilsales.eunorth@vishay.com
- GERMANY/CZECH REPUBLIC/AUSTRIA: foilsales.eucentral@vishay.com
- FRANCE/SWITZERLAND/SOUTHERN EUROPE: foilsales.eusouth@vishay.com
- ISRAEL: foilsales.israel@vishay.com

Power Current Sense Resistors



Vishay Foil Resistors

Z-Based Bulk Metal® Foil Technology
Rapid ΔR Stabilization - Low WCR - Low TCR

FIGURE 6 - STANDARD IMPRINTING AND DIMENSIONS

VHP4Z

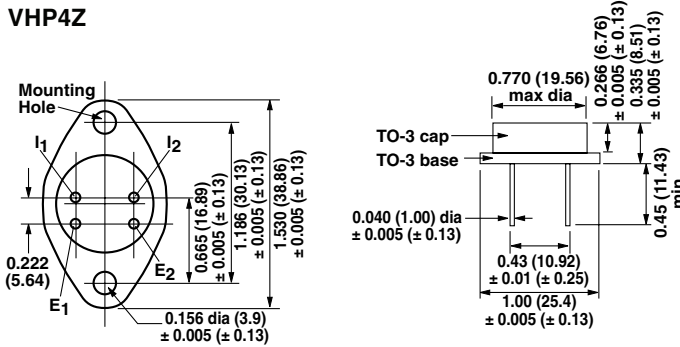

Standard Marking Arrangement

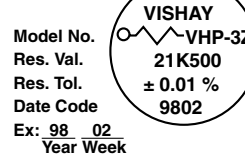

VPR247Z

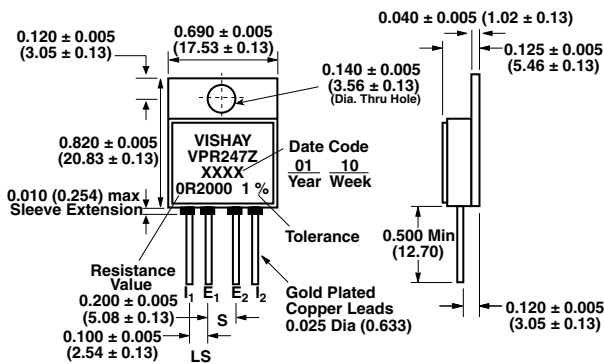

VFP4Z

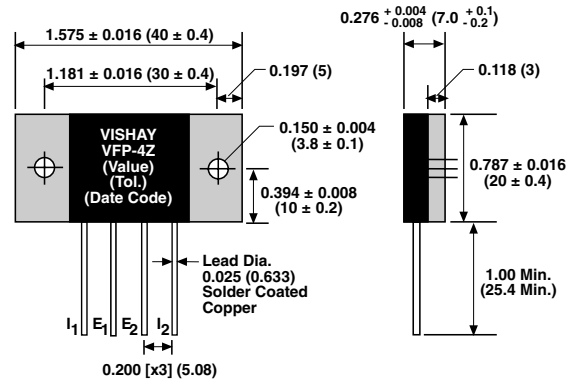

VCS331Z

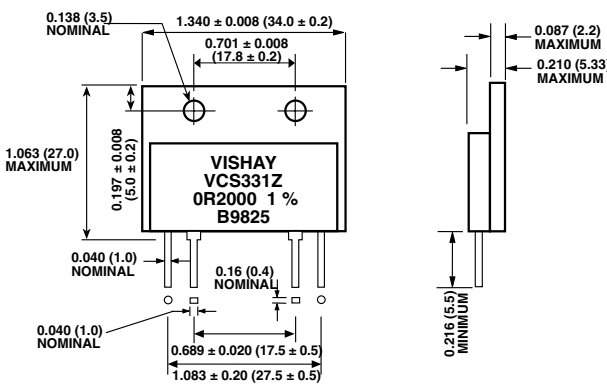

VCS332Z

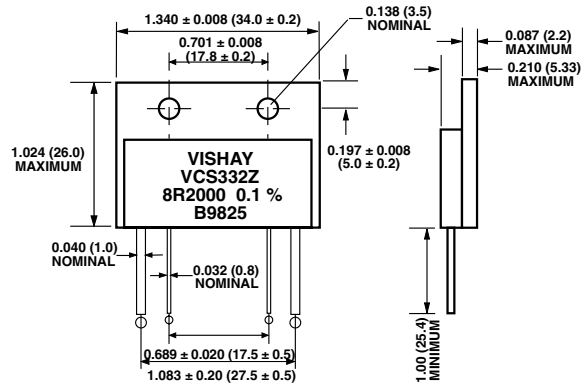

SALES

- AMERICAS: foilsales.usa@vishay.com
- ASIA/JAPAN: foilsales.asia@vishay.com
- UK/HOLLAND/SCANDINAVIA: foilsales.eunorth@vishay.com
- GERMANY/CZECH REPUBLIC/AUSTRIA: foilsales.eucentral@vishay.com
- FRANCE/SWITZERLAND/SOUTHERN EUROPE: foilsales.eusouth@vishay.com
- ISRAEL: foilsales.israel@vishay.com



Power Current Sense Resistors

Z-Based Bulk Metal® Foil Technology Vishay Foil Resistors
 Rapid ΔR Stabilization - Low WCR - Low TCR

TABLE 1 - RESISTANCE VALUE VS TOLERANCE	
RESISTANCE RANGE (Ω)	STANDARD TOLERANCE (%)
10 to 500	± 0.01 %
5 to < 10	± 0.02 %
2 to < 5	± 0.05 %
1 to < 2	± 0.10 %
0.5 to < 1	± 0.25 %
0.25 to < 0.5	± 0.50 %

TABLE 2 - SPECIFICATIONS	
TEST OR CONDITION	PERFORMANCE
Wattage Coefficient of Resistance (WCR)	4 ppm/Watt Maximum ¹⁾
Temperature Coefficient of Resistance (TCR) (- 55 °C to + 125 °C, + 25 °C Reference)	≥ 1.0 Ω to 500 Ω, ± 2 ppm/°C Maximum 0R25 to < 1.0 Ω, ± 3 ppm/°C Maximum
Thermal Resistance	6 °C/Watt ¹⁾
Maximum Ambient Temperature	
Rated Power	+ 25 °C
Zero Power	+ 150 °C
Power Rating at + 25 °C	
VHP4Z	10 Watts or 3 Amps Maximum (Heat Sink) ^{2), 3)}
VPR247Z	3 Watts or 3 Amps Maximum (Free Air) ³⁾
VFP4Z	
VCS331Z	10 Watts or 5 Amps Maximum (Heat Sink) ^{2), 3)}
VCS332Z	3 Watts or 5 Amps Maximum (Free Air) ³⁾
Load Life Stability	± 0.05 % Max ΔR, 10 W on heat sink at + 25 °C, 2000 hours ± 0.01 % Max ΔR, 3 W on heat sink at + 25 °C, 2000 hours ± 0.05 % Max ΔR, 3 W in free air at + 25 °C, 2000 hours
Inductance	0.1 μH Maximum; 0.08 μH Typical
Voltage Coefficient	< 0.1 ppm/V
Current Noise	< 0.010 μV(RMS)/Volt of applied voltage (- 40 dB)

NOTES:

1. Mounted on a cooled heat sink held at + 25°C
2. Heatsink - Aluminum (6" L x 4" W x 2" H x 0.04" THK)
3. Whichever is lower

TABLE 3 - ORDERING INFORMATION				
Please specify Vishay VHP4Z, VPR247Z, VFP4Z, VCS331Z, VCS332Z series resistors as follows:				
MODEL NO.	RESISTANCE VALUE			TOLERANCE
VHP4Z	RESISTANCE RANGE	LETTER DESIGNATOR	MULTIPLIER FACTOR	0.01 %
	0.25 to < 500 Ω	R	x 1	
Example: 100R01 = 100.01 Ω				
Resistance Value, in Ω, is expressed by a series of 6 characters, 5 of which represent significant digits while the 6th is a dual purpose letter that designates both the multiplier and the location of the comma or decimal.				

SALES

- AMERICAS: foilsales.usa@vishay.com
- ASIA/JAPAN: foilsales.asia@vishay.com
- UK/HOLLAND/SCANDINAVIA: foilsales.eunorth@vishay.com
- GERMANY/CZECH REPUBLIC/AUSTRIA: foilsales.eucentral@vishay.com
- FRANCE/SWITZERLAND/SOUTHERN EUROPE: foilsales.eusouth@vishay.com
- ISRAEL: foilsales.israel@vishay.com



Disclaimer

All product specifications and data are subject to change without notice.

Vishay Intertechnology, Inc., its affiliates, agents, and employees, and all persons acting on its or their behalf (collectively, "Vishay"), disclaim any and all liability for any errors, inaccuracies or incompleteness contained herein or in any other disclosure relating to any product.

Vishay disclaims any and all liability arising out of the use or application of any product described herein or of any information provided herein to the maximum extent permitted by law. The product specifications do not expand or otherwise modify Vishay's terms and conditions of purchase, including but not limited to the warranty expressed therein, which apply to these products.

No license, express or implied, by estoppel or otherwise, to any intellectual property rights is granted by this document or by any conduct of Vishay.

The products shown herein are not designed for use in medical, life-saving, or life-sustaining applications unless otherwise expressly indicated. Customers using or selling Vishay products not expressly indicated for use in such applications do so entirely at their own risk and agree to fully indemnify Vishay for any damages arising or resulting from such use or sale. Please contact authorized Vishay personnel to obtain written terms and conditions regarding products designed for such applications.

Product names and markings noted herein may be trademarks of their respective owners.