

# M63836FP/KP

8-UNIT 500mA DARLINGTON TRANSISTOR-ARRAY WITH CLAMP DIODE

**PRELIMINARY**  
 Notice: This is not a final specification.  
 Some parametric limits are subject to change.

**DESCRIPTION**

The M63836FP/KP 8-channel sinkdriver, consists of 8 PNP and 16 NPN transistors connected to from eight high current gain driver pairs.

**FEATURES**

- High breakdown voltage ( $BV_{CEO} \geq 50V$ )
- High-current driving ( $I_{C(max)} = 500mA$ )
- 3V micro computer compatible input
- "L" active level input
- With input diode
- With clamping diodes
- Wide operating temperature range ( $T_a = -40$  to  $+85^\circ C$ )

**APPLICATION**

Output for 3 voltage microcomputer series and interface with high voltage system. Relay and small printer driver, LED, or incandescent display digit driver.

**FUNCTION**

The M63836FP/KP is transistor-array of high active level eight units type which can do direct drive of 3 voltage micro-computer series. A resistor of  $3.5k\Omega$  is connected between the input and the base of PNP transistors. A clamp diode for inductive load transient suppression is connected for the output pin (collector) and COM pin. The input diode is intended to prevent the flow of current from the input to the Vcc. without this diode, the current flows from "H" input to the Vcc and the "L" input circuit is activated, in such a case where one of the inputs of the 8 circuit is "H" and the other are "L" to save power consumption. The diode is inserted to prevent such mis-operation. The outputs are capable of driving 500mA and are rated for operation with output voltage up to 50V.

**PIN CONFIGURATION**

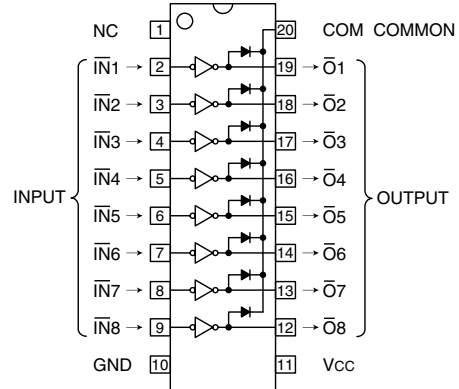

20P2N-A(FP) NC : No connection  
 Package type 20P2E-A(KP)

**CIRCUIT DIAGRAM**

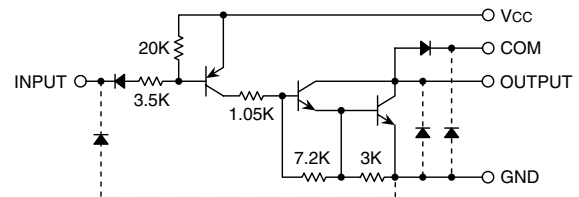

The eight circuits share the Vcc, COM and GND  
 The diode, indicated with the dotted line, is parasitic, and cannot be used.

Unit :  $\Omega$

**ABSOLUTE MAXIMUM RATINGS** (Unless otherwise noted,  $T_a = -40 \sim +85^\circ C$ )

Symbol	Parameter	Conditions	Ratings	Unit
Vcc	Supply voltage		7	V
VCEO	Collector-emitter voltage	Output, H	-0.5 ~ +50	V
IC	Collector current	Current per circuit output, L	500	mA
VI	Input voltage		-0.5 ~ Vcc	V
IF	Clamping diode forward current		500	mA
VR	Clamping diode reverse voltage		50	V
Pd	Power dissipation	$T_a = 25^\circ C$ , when mounted on board	1.10(FP)/0.68(KP)	W
Topr	Operating temperature		-40 ~ +85	$^\circ C$
Tstg	Storage temperature		-55 ~ +125	$^\circ C$

**PRELIMINARY**  
 Notice: This is not a final specification.  
 Some parametric limits are subject to change.

**M63836FP/KP**

8-UNIT 500mA DARLINGTON TRANSISTOR-ARRAY WITH CLAMP DIODE

**RECOMMENDED OPERATING CONDITIONS** (Unless otherwise noted, Ta = -40 ~ +85°C)

Symbol	Parameter	Limits			Unit	
		min	typ	max		
Vcc	Supply voltage	2.7	3.0	3.6	V	
Ic	Collector current (Current per 1 circuit when 8 circuits are coming on simultaneously)	Duty Cycle FP : no more than 4% KP : no more than 2%	0	—	400	mA
		Duty Cycle FP : no more than 15% KP : no more than 6%	0	—	200	
VIH	"H" input voltage	Vcc-0.5	—	Vcc	V	
VIL	"L" input voltage	0	—	Vcc-2.2	V	

**ELECTRICAL CHARACTERISTICS** (Unless otherwise noted, Ta = -40 ~ +85°C)

Symbol	Parameter	Test conditions	Limits			Unit
			min	typ*	max	
V (BR) CEO	Collector-emitter breakdown voltage	ICEO = 100µA	50	—	—	V
VCE(sat)	Collector-emitter saturation voltage	VCC = 2.7V, VI = 0.5V, IC = 400mA	—	1.15	2.4	V
		VCC = 2.7V, VI = 0.5V, IC = 200mA	—	0.93	1.6	
Ii	Input current	VI = Vcc-2.2V	—	-220	-600	µA
VF	Clamping diode forward voltage	IF = 400mA	—	1.4	2.4	V
IR	Clamping diode reverse current	VR = 50V	—	0.1	100	µA
ICC	Supply current (AN only Input)	VCC = 3.6V, VI = 0.5V	—	2.6	4.0	mA
hFE	DC amplification factor	VCC = 2.7V, VCE = 2V, IC = 0.35A, Ta = 25°C	2000	10000	—	—

\* : Typical values are at Ta = 25°C

**SWITCHING CHARACTERISTICS** (Unless otherwise noted, Ta = 25°C)

Symbol	Parameter	Test conditions	Limits			Unit
			min	typ	max	
ton	Turn-on time	CL = 15pF (note 1)	—	120	—	ns
toff	Turn-off time		—	4500	—	ns

**NOTE 1 TEST CIRCUIT**

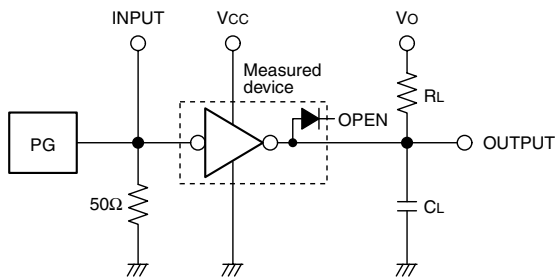

- (1) Pulse generator (PG) characteristics : PRR=1kHz, tw = 10µs, tr = 6ns, tf = 6ns, Zo = 50Ω, VI = 0.5 ~ 2.7V
- (2) Input-output conditions : RL = 30Ω, Vo = 10V, Vcc = 2.7V
- (3) Electrostatic capacity CL includes floating capacitance at connections and input capacitance at probes

**TIMING DIAGRAM**

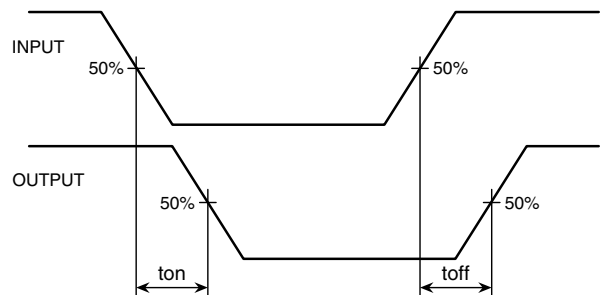

**PRELIMINARY**  
 Notice: This is not a final specification.  
 Some parametric limits are subject to change.

8-UNIT 500mA DARLINGTON TRANSISTOR-ARRAY WITH CLAMP DIODE

TYPICAL CHARACTERISTICS

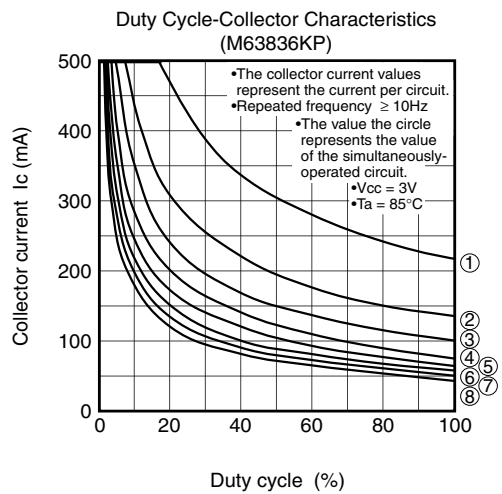
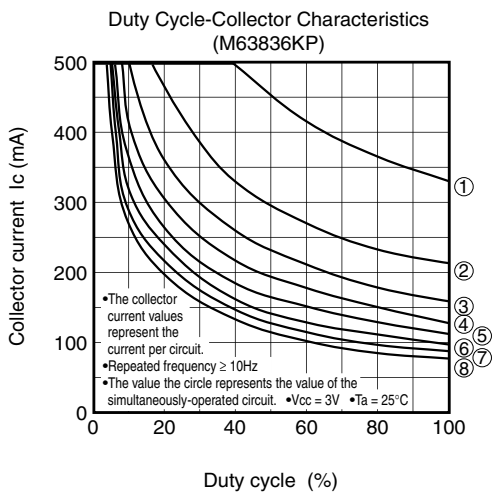
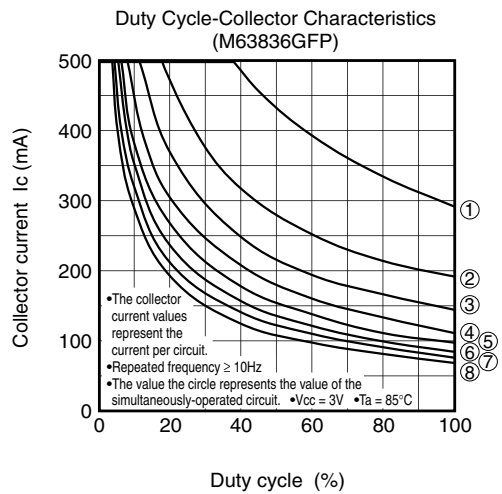
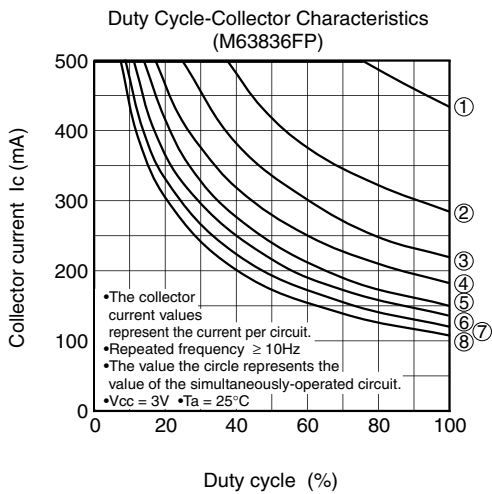
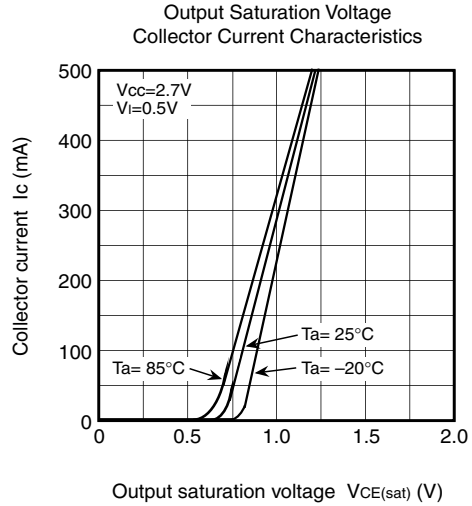
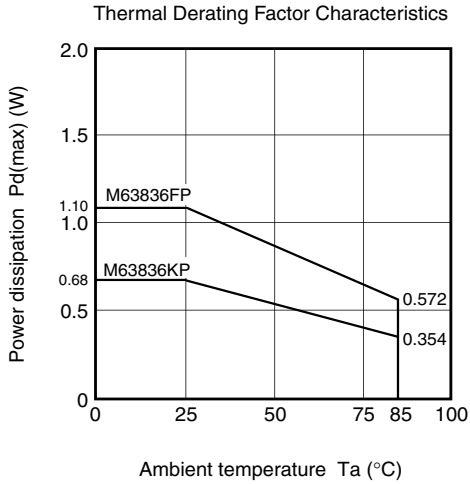

**PRELIMINARY**  
 Notice: This is not a final specification.  
 Some parametric limits are subject to change.

8-UNIT 500mA DARLINGTON TRANSISTOR-ARRAY WITH CLAMP DIODE

DC Amplification Factor  
 Collector Current Characteristics

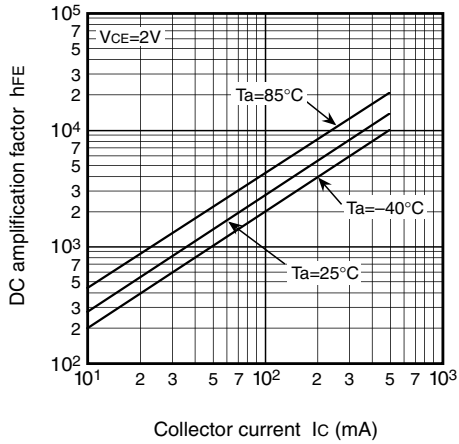

Output Current Characteristics

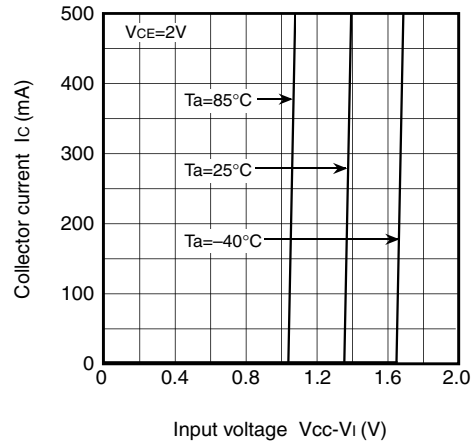

Input Characteristics

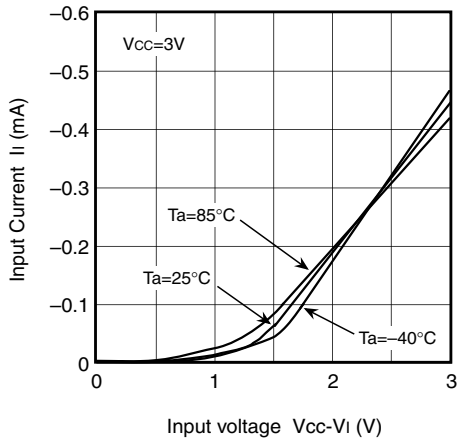

Driver Supply Characteristics

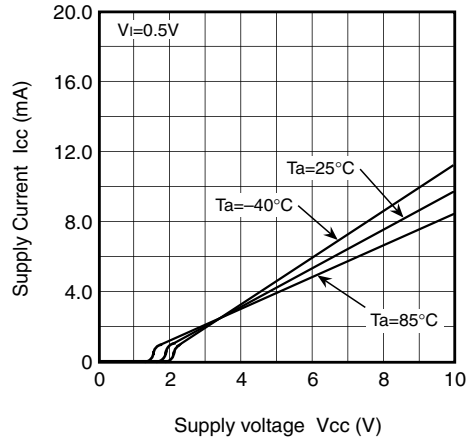

Clamping Diode Characteristics

