

W-band Low Noise Amplifier

Preliminary

GaAs Monolithic Microwave IC

Description

The CHA1077a is a W-band monolithic 3-stages low noise amplifier. All the active devices are internally self-biased. This chip is compatible with automatic equipment for assembly.

The circuit is manufactured on P-HEMT process: 0.15µm gate length, via holes through the substrate, air bridges and electron beam gate lithography.

It is available in chip form.

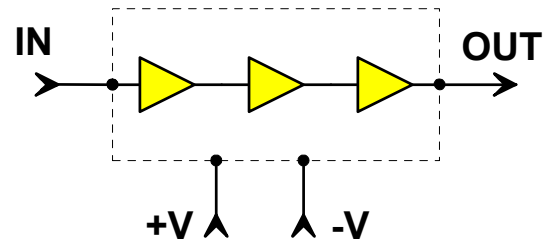

W-band amplifier block-diagram

Main Features

- W-band low noise amplifier
- High gain
- Wide operating frequency range
- High temperature range
- On-chip self biasing
- Additional external resistor allows to choose getting more gain instead of a minimum noise factor
- Automatic assembly oriented
- Low DC power consumption
- BCB layer protection
- Chip size: 2.6 x 1.32 x 0.1mm

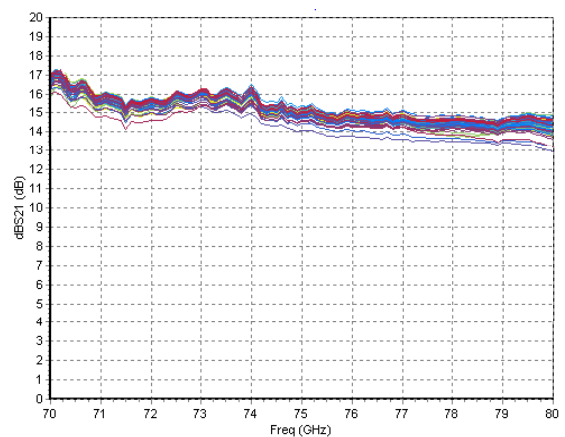

Small signal gain

Main Characteristics

Tamb = +25°C

Symbol	Parameter	Min	Typ	Max	Unit
F_op	Operating frequency	76		77	GHz
G_lin	Small signal gain		15		dB
NF	Noise figure		4.5		dB
P_1dB	Output power at 1dB gain compression		9		dBm

ESD Protections : Electrostatic discharge sensitive device observe handling precautions !

Electrical Characteristics

Full operating temperature range, used according to section "Typical assembly and bias configuration".

Symbol	Parameter	Min	Typ	Max	Unit
F_op	Operating frequency	76		77	GHz
G_lin	Small signal gain	11	15	19	dB
G_fl	Small signal gain flatness		0.5	1	dB
NF	Noise figure		4.5	6.5	dB
P_out_1dB	Output power at 1dB gain compression	6	9		dBm
Is	Reverse isolation	20	30		dB
VSWR_in	VSWR at input port (50Ω)		2:1	2.5:1	
VSWR_out	VSWR at output port (50Ω)		2:1	2.5:1	
+V	Positive supply voltage (1)	4.4	4.5	4.6	V
+I	Positive supply current		40	70	mA
-V	Negative supply voltage (1)	-4.6	-4.5	-4.4	V
-I	Negative supply current	-10	-6	0	mA
Top	Operating temperature range	-40		100	°C

(1) Negative supply voltage must be applied at least 1us before positive supply voltage.

Absolute Maximum Ratings (1)

Symbol	Parameter	Values	Unit
P_in	Maximum input power (2)	3	dBm
+V	Positive supply voltage	5	V
-V	Negative supply voltage	-5	V
+I	Positive supply current	80	mA
-I	Negative supply current	-13	mA
Tstg	Storage temperature range	-55 to +155	°C

- (1) Operation of this device above any one of these parameters may cause permanent damage.
 (2) CW mode

Chip Mechanical Data and Pin References

Preliminary

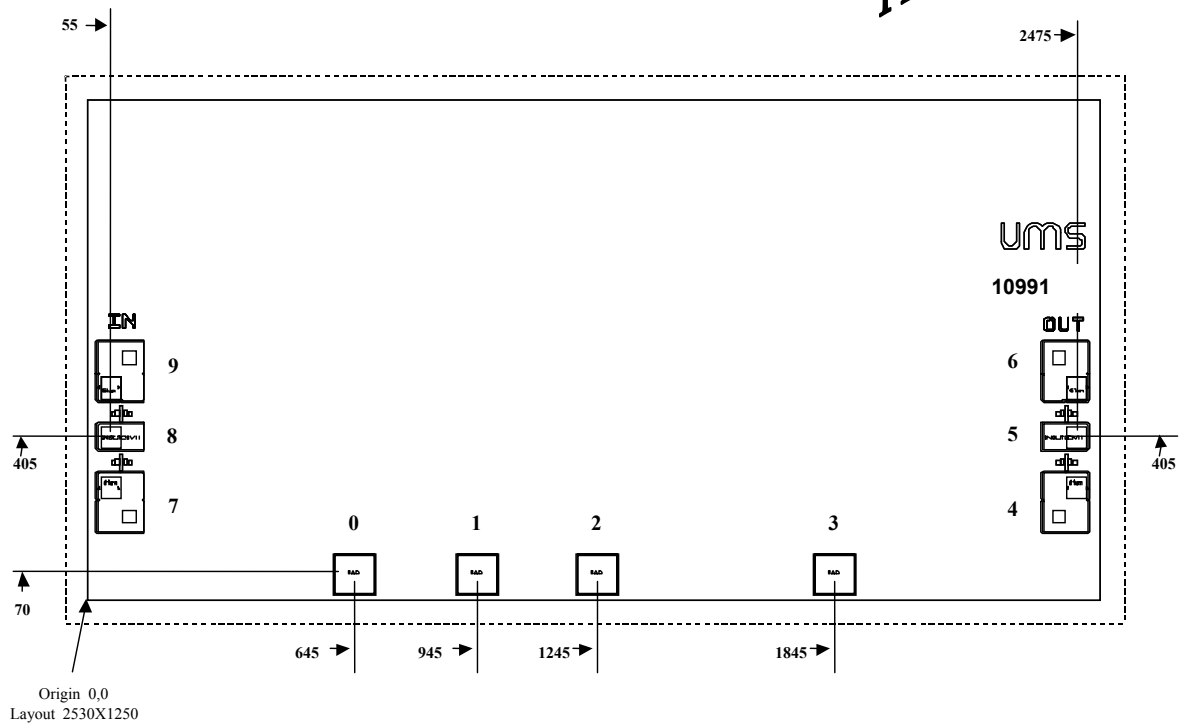

Unit = μm

External chip size (layout size + dicing streets) = 2600X1320 +/- 35

Chip thickness = 100 +/- 10

HF Pads (5,8) = 105 X 86 (BCB opening)

DC/IF Pads = 86 x 83 (BCB opening)

Pin number	Pin name	Description
4, 6, 7, 9		Ground: should not be bonded. If required, please ask for more information.
3		Ground (optional)
5	OUT	RF output port
8	IN	RF input port
0	+V	Positive supply voltage
1	-V1	Negative supply voltage for the first stage
2	-V23	Negative supply voltage for the second and third stage

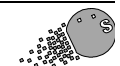

Typical Assembly and Bias Configuration to get minimum noise figure :

Preliminary

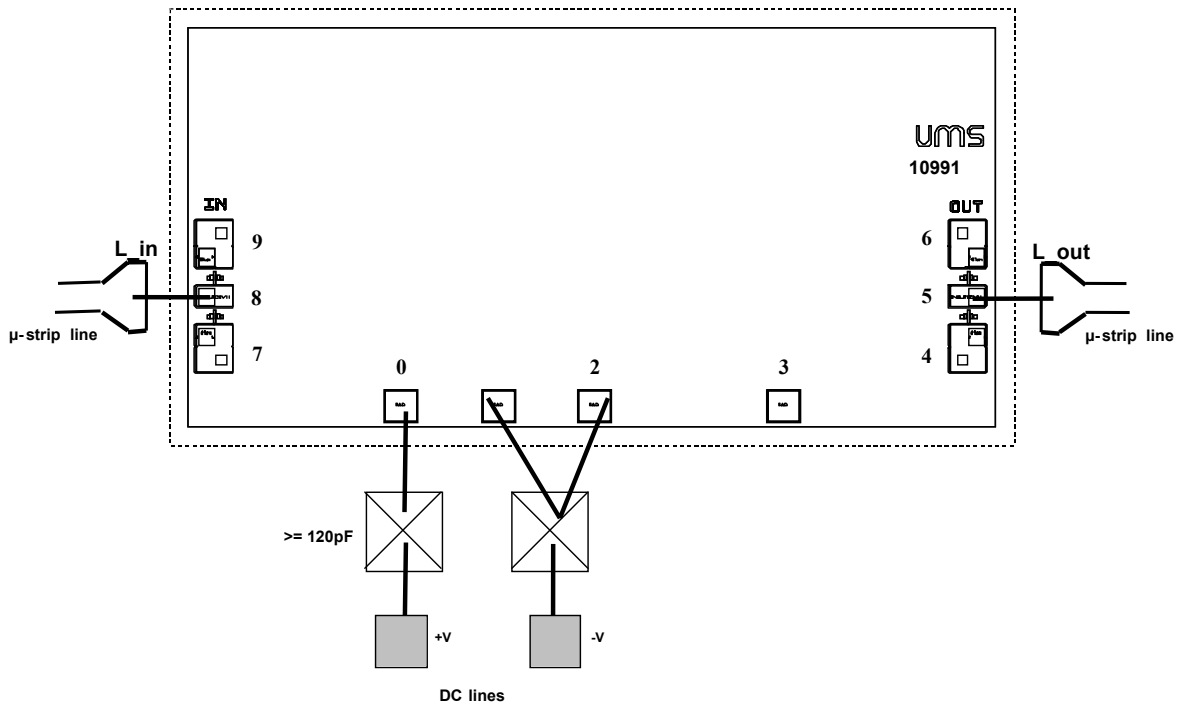

This drawing shows an example of assembly and bias configuration. All the transistors are internally self-biased. An external capacitor is recommended for the positive and negative supply voltages. For the RF pads the equivalent wire bonding inductance (diameter=25μm) have to be according to the following recommendation.

Port	Equivalent inductance (nH)	Wire length (mm) (1)
IN	L_in = 0.25	0.34
OUT	L_out = 0.25	0.34

(1) This value is the total length including the necessary loop from pad to pad.

For a micro-strip configuration a hole in the substrate is necessary for chip assembly.

Typical Assembly and Bias Configuration to increase the gain :

Preliminary

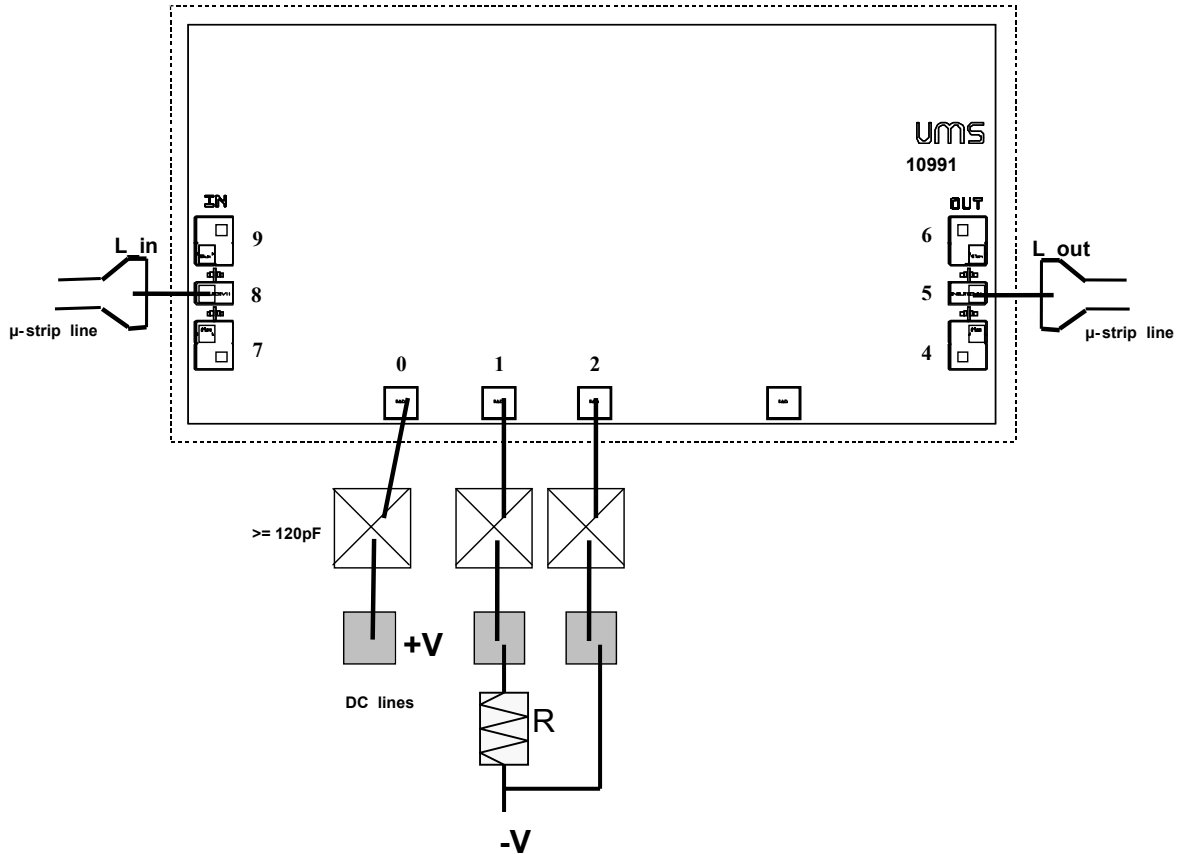

Let's tune the value of the external resistor R to control the biasing point of the first stage and then getting a higher gain for the LNA (trade-off ability between the gain and the noise factor).

Typical value of the external resistor R :

R (kΩ)	Description
0	Low-noise configuration
2	Maximum gain configuration

Preliminary

As the connections at 77GHz (between MMIC and MMIC or between MMIC and external substrate) are critical, the transition matching network is split into two parts: one on MMIC and one on the external substrate. This choice allows doing also a direct connection between MMICs. For a connection to an external substrate a network is proposed on soft substrate for IN and OUT ports. The following drawings give the dimensions for a RO3003 substrate (thickness=0.127mm, $\epsilon_r=3$).

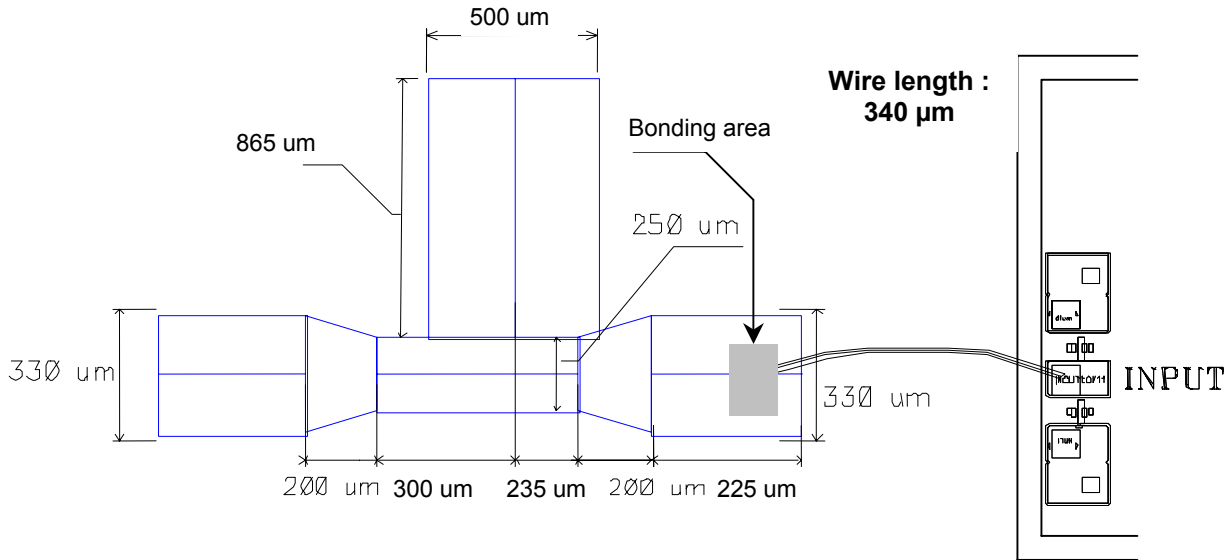

Proposed matching network for a 50Ω transition between IN port and a μ-strip line on RO3003 substrate

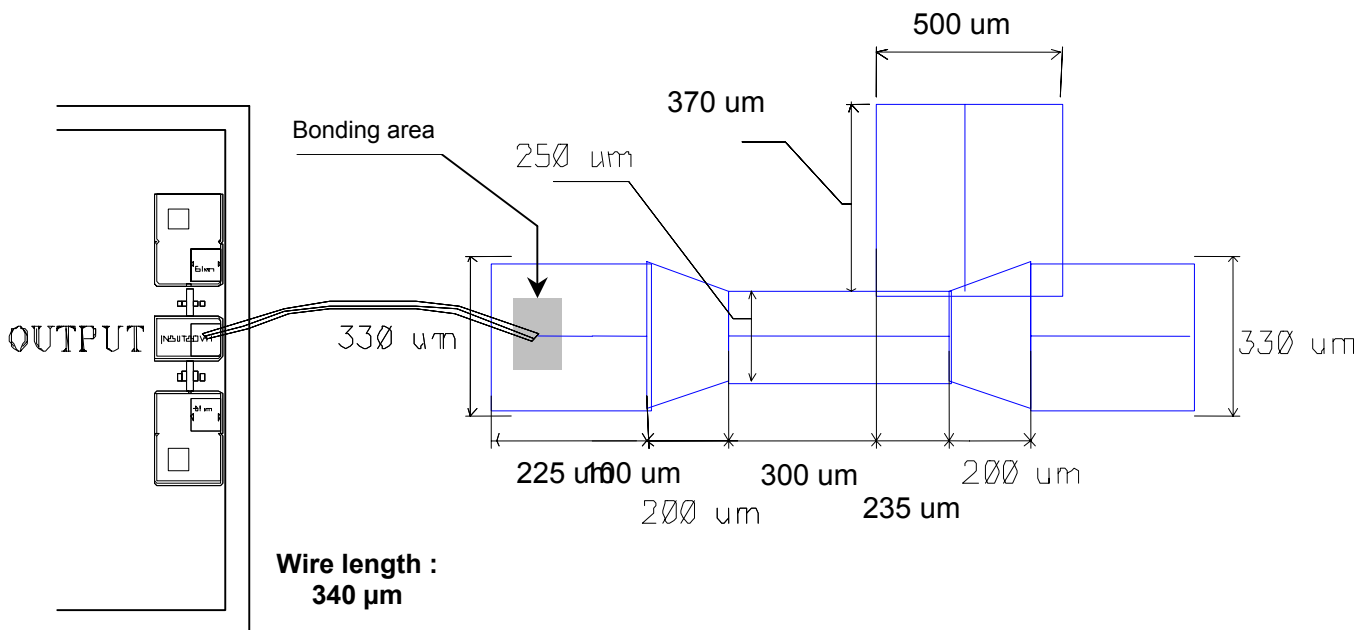

Proposed matching network for a 50Ω transition between OUT port and a μ-strip line on RO3003 substrate

Preliminary

Ordering Information

Chip form : CHA1077a98F/00

Information furnished is believed to be accurate and reliable. However **United Monolithic Semiconductors S.A.S.** assumes no responsibility for the consequences of use of such information nor for any infringement of patents or other rights of third parties which may result from its use. No license is granted by implication or otherwise under any patent or patent rights of **United Monolithic Semiconductors S.A.S.**. Specifications mentioned in this publication are subject to change without notice. This publication supersedes and replaces all information previously supplied. **United Monolithic Semiconductors S.A.S.** products are not authorized for use as critical components in life support devices or systems without express written approval from **United Monolithic Semiconductors S.A.S.**