

END-LOOK PACKAGE PIN PHOTO DIODE

● Features

1. Wide receiving angle
2. Linear response vs. irradiance
3. Fast switching time
4. End-looking Package ideal for space limited applications
5. Lens Appearance: Black
6. This product doesn't contain restriction substance, comply ROHS standard

● Description

The BPD-BQBA34 device consists of a PIN silicon photodiode molded in a black epoxy package which allows spectral response infrared light wavelengths. The wide receiving angle provides relatively even reception over a large area. The side-looking package is designed for easy PC board mounting. This photodiode is mechanically and spectrally matched to BRIGHT's GaAs and GaAlAs series of infrared emitting diodes.

● Absolute Maximum Ratings(Ta=25°C)

Parameter	Maximum Rating	Unit
Power Dissipation	100	mW
Reverse Breakdown Voltage	60V	
Operating Temperature	-45°C ~ +85°C	
Storage Temperature Range	-45°C ~ +100°C	
Lead Soldering Temperature	260°C for 5 seconds	

● Package Dimensions:

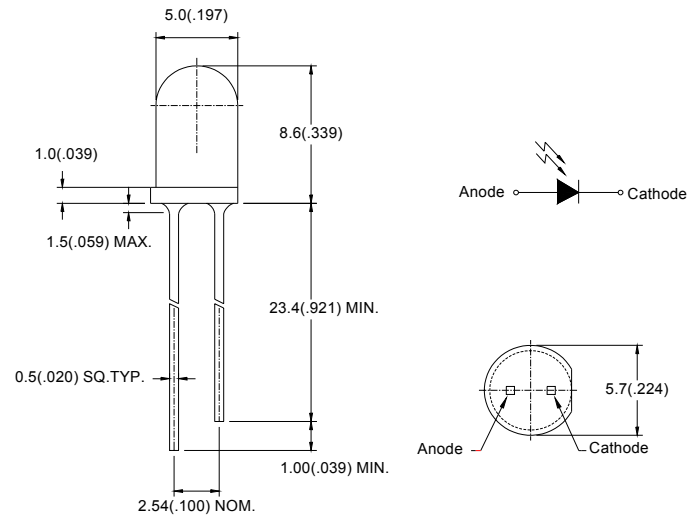

NOTES:

1. All dimensions are in millimeters (inches).
2. Tolerance is $\pm 0.25\text{mm}$ (0.01') unless otherwise specified.
3. Lead spacing is measured where the leads emerge from the package
4. Specifications are subject to change without notice

● **Electrical Characteristics** (TA=25°C unless otherwise noted)

PARAMETER	SYMBOL	MIN	TYP	MAX	UNITS	TEST CONDITIONS
Reverse Light Current	I_L	-	42	-	μA	$V_R=5\text{V}, E_e=1\text{mW}/\text{cm}^2$
Reverse Dark Current	I_D	-	-	30	nA	$V_R=10\text{V}, E_e=0\text{mW}/\text{cm}^2$
Reverse Break down Voltage	$V_{(BR)}$	60	-	-	V	$I_R=100\mu\text{A}$
Forward Voltage	V_F	-	-	1.2	V	$I_F=1\text{mA}$
Total Capacitance	C_T	-	21	-	PF	$V_R=5\text{V}, E_e=0, f=1.0\text{MHZ}$
Rise Time/ Fall Time	tr/ tf	-	40	-	ns	$V_R=20\text{V}, \lambda=850\text{nm}, R_L=50\Omega$

● **Typical Optical-Electrical Characteristic Curves**

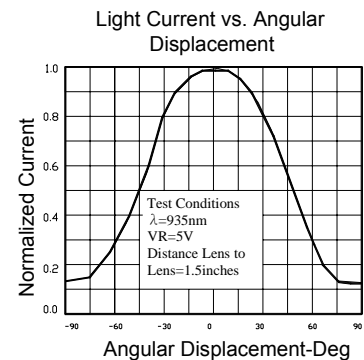
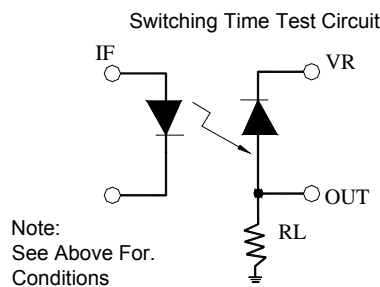
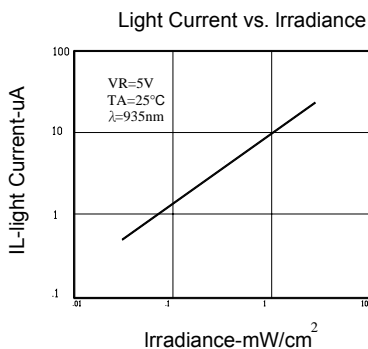
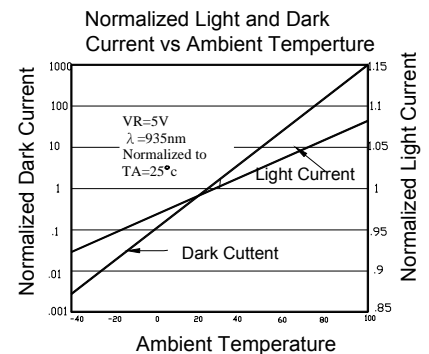
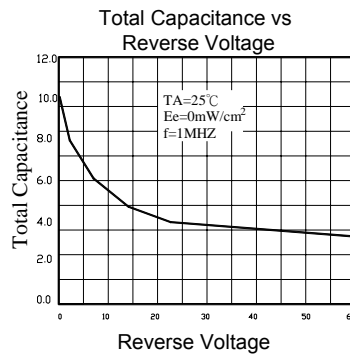
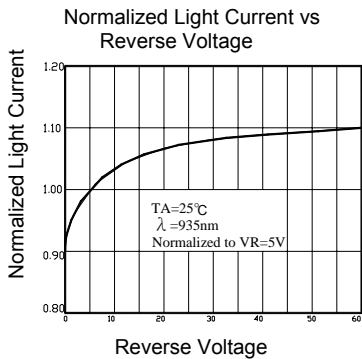
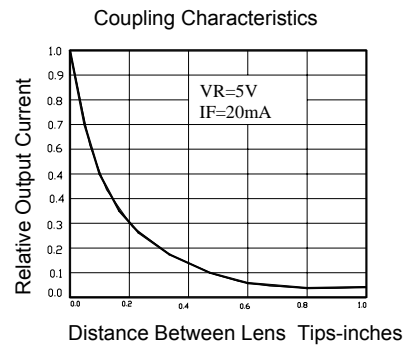
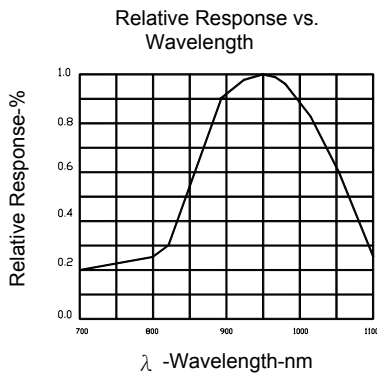

● Tapping and packaging specifications(Units: mm)

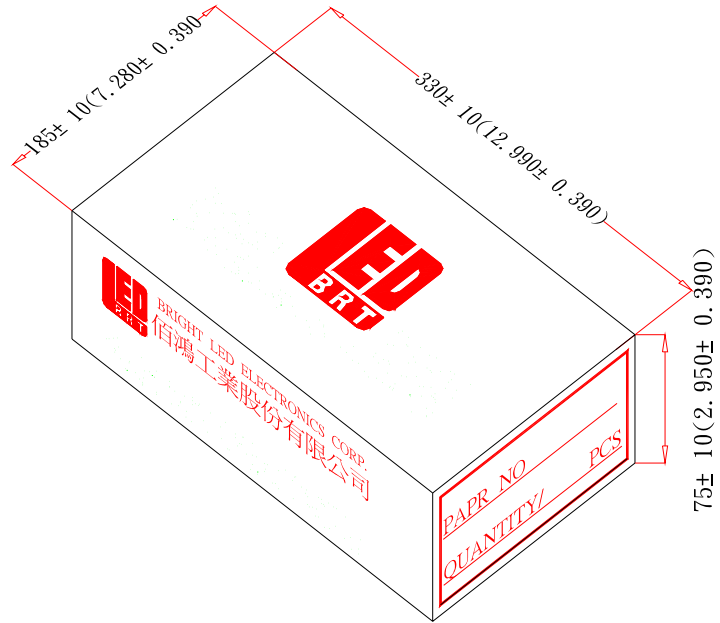

● Packaging Bag Dimensions

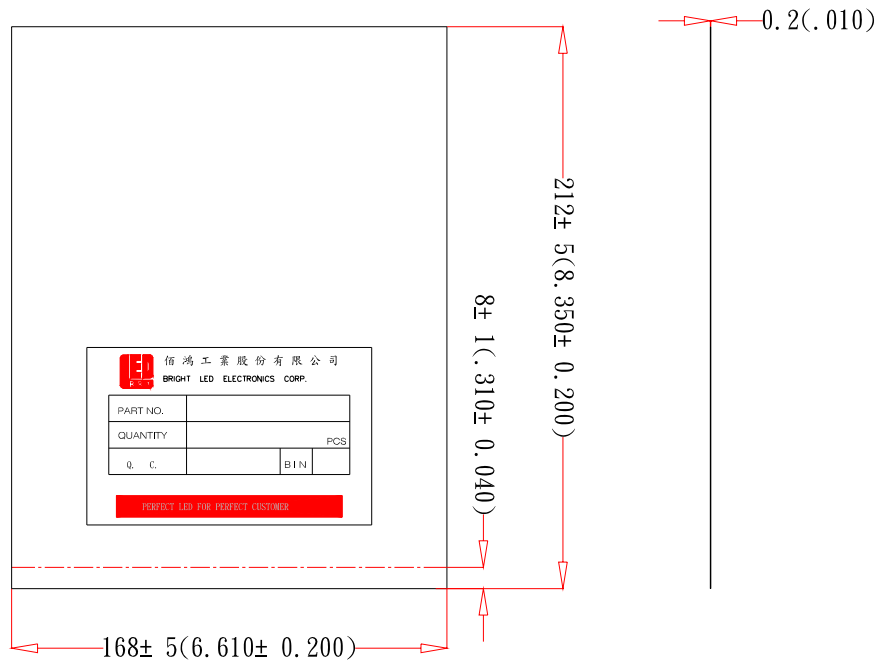

Notes:

- 1、500pcs per bag,5Kpcs per box.
- 2、All dimensions are in millimeters(inches).
- 3、Specifications are subject to change without notice.