

Part Number: WP483SRSGW

Super Bright Red
Super Bright Green

Features

- CYLINDRICAL TYPE, TOP DIFFUSED.
- I.C. COMPATIBLE.
- LOW POWER CONSUMPTION.
- RELIABLE AND RUGGED.
- LONG LIFE-SOLID STATE RELIABILITY.
- AVAILABLE ON TAPE AND REEL.
- RoHS COMPLIANT.

Description

The Super Bright Red source color devices are made with Gallium Aluminum Arsenide Red Light Emitting Diode.
The Super Bright Green source color devices are made with Gallium Phosphide Green Light Emitting Diode.

Package Dimensions

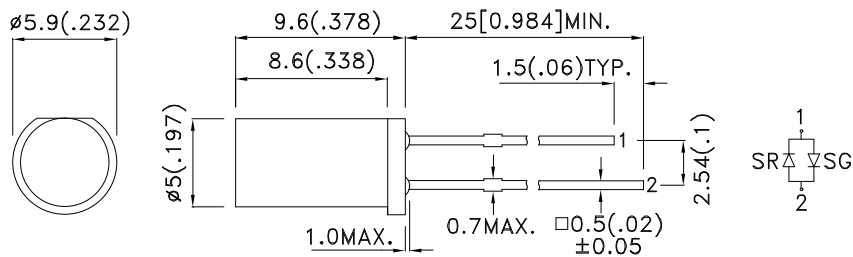

Notes:

1. All dimensions are in millimeters (inches).
2. Tolerance is $\pm 0.25 (0.01)$ unless otherwise noted.
3. Lead spacing is measured where the leads emerge from the package.
4. Specifications are subject to change without notice.



Selection Guide

| Part No. | Dice | Lens Type | Iv (mcd) [2] @ 20mA | | Viewing Angle [1] |
|------------|---------------------------|----------------|------------------------|------|----------------------|
| | | | Min. | Typ. | 2θ1/2 |
| WP483SRSGW | Super Bright Red (GaAlAs) | WHITE DIFFUSED | 18 | 50 | 80° |
| | Super Bright Green (GaP) | | 4 | 10 | |

Notes:

1. θ1/2 is the angle from optical centerline where the luminous intensity is 1/2 the optical centerline value.
2. Luminous intensity/ luminous Flux: +/-15%.

Electrical / Optical Characteristics at TA=25°C

| Symbol | Parameter | Device | Typ. | Max. | Units | Test Conditions |
|--------------------|--------------------------|--|-------------|------------|-------|---------------------------|
| λ _{peak} | Peak Wavelength | Super Bright Red Super Bright Green | 660 565 | | nm | I _F =20mA |
| λ _D [1] | Dominant Wavelength | Super Bright Red Super Bright Green | 640 568 | | nm | I _F =20mA |
| Δλ _{1/2} | Spectral Line Half-width | Super Bright Red Super Bright Green | 20 30 | | nm | I _F =20mA |
| C | Capacitance | Super Bright Red Super Bright Green | 45 15 | | pF | V _F =0V;f=1MHz |
| V _F [2] | Forward Voltage | Super Bright Red Super Bright Green | 1.85 2.2 | 2.5 2.5 | V | I _F =20mA |

Notes:

1. Wavelength: +/-1nm.
2. Forward Voltage: +/-0.1V.

Absolute Maximum Ratings at TA=25°C

| Parameter | Super Bright Red | Super Bright Green | Units |
|---------------------------------|---------------------|--------------------|-------|
| Power dissipation | 75 | 62.5 | mW |
| DC Forward Current | 30 | 25 | mA |
| Peak Forward Current [1] | 155 | 140 | mA |
| Operating / Storage Temperature | -40°C To +85°C | | |
| Lead Solder Temperature [2] | 260°C For 3 Seconds | | |
| Lead Solder Temperature [3] | 260°C For 5 Seconds | | |

Notes:

1. 1/10 Duty Cycle, 0.1ms Pulse Width.
2. 2mm below package base.
3. 5mm below package base.

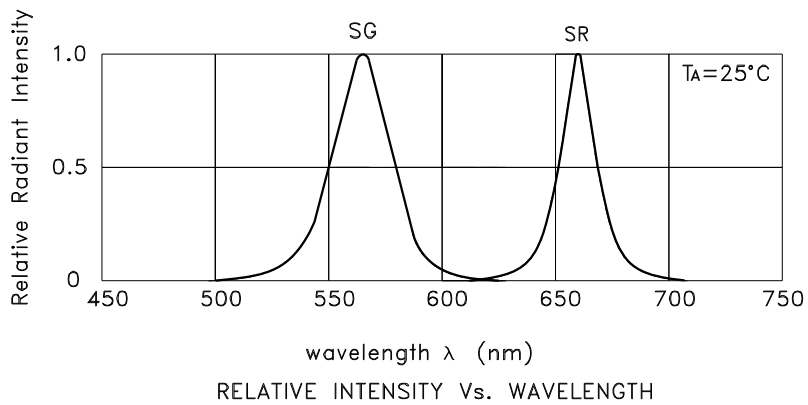

WP483SRSGW Super Bright Red

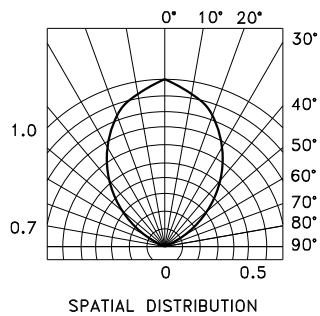
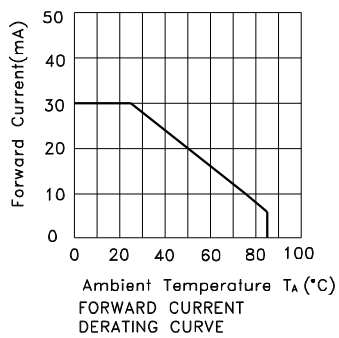
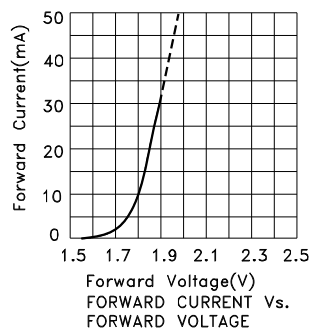

Kingbright

Super Bright Green

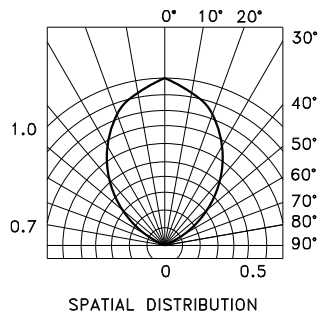
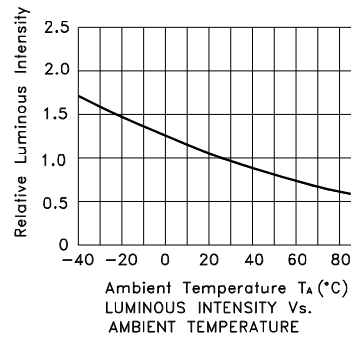
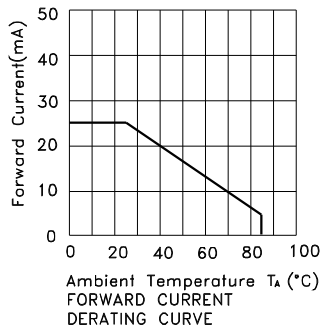
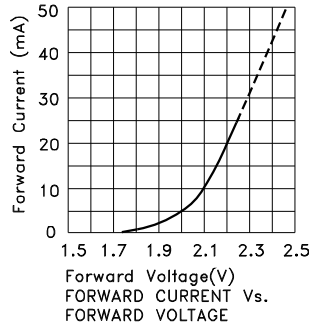

PACKING & LABEL SPECIFICATIONS

WP483SRSGW

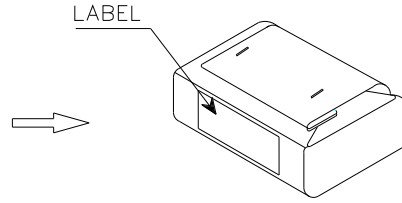
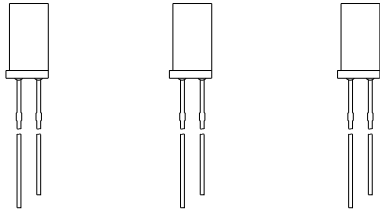

500 PCS/BAG

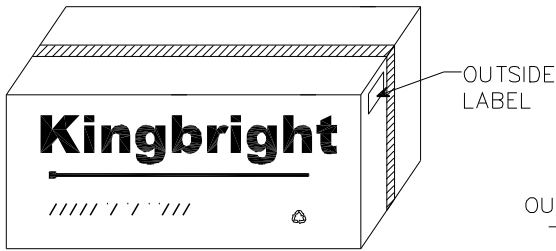

32K/9# BOX

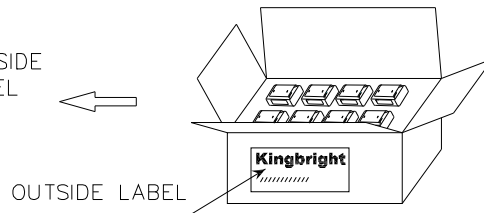

16K/5# BOX

| | |
|---------------------|---|
| <h1>Kingbright</h1> | |
| Q.C. | <div style="border: 1px solid black; border-radius: 50%; padding: 5px; display: inline-block;"> QC XXX XX. XXXX PASSED </div> |
| TYPE NO : WP483XXX | |
| QUANTITY : 500 pcs | |
| S/N : XXX | CODE: XXXX |
| LOT NO : |  xx-xxxxxx |
| RoHS Compliant | |

LED MOUNTING METHOD

1. The lead pitch of the LED must match the pitch of the mounting holes on the PCB during component placement. Lead-forming may be required to insure the lead pitch matches the hole pitch. Refer to the figure below for proper lead forming procedures.

(Fig. 1)

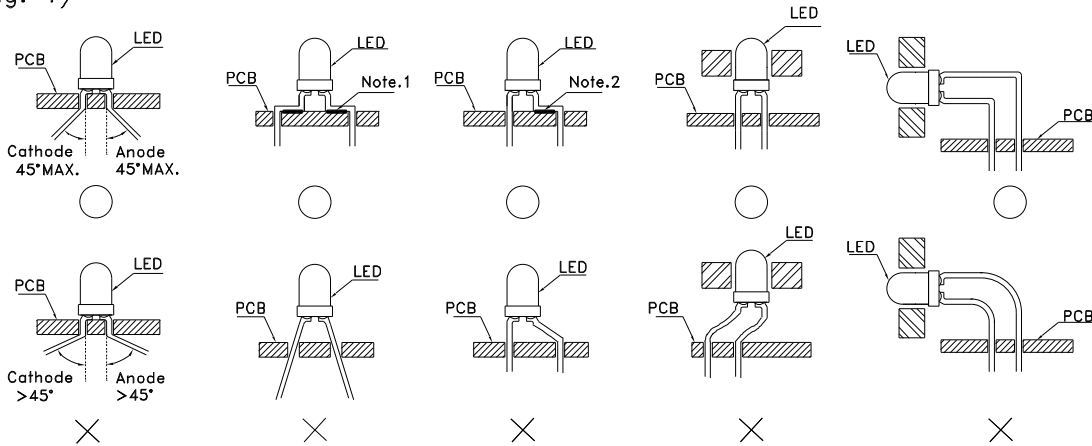

Fig.1

“○” Correct mounting method “×” Incorrect mounting method

Note 1-2 : Do not route PCB trace in the contact area between the leadframe and the PCB to prevent short-circuits.

2. When soldering wire to the LED, use individual heat-shrink tubing to insulate the exposed leads to prevent accidental contact short-circuit.

(Fig. 2)

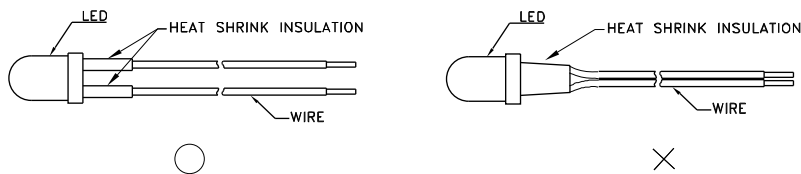

Fig. 2

3. Use stand-offs (Fig. 3) or spacers (Fig. 4) to securely position the LED above the PCB.

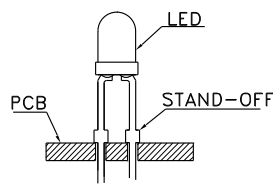

Fig. 3

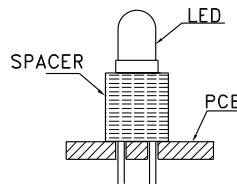

Fig. 4

LEAD FORMING PROCEDURES

1. Maintain a minimum of 2mm clearance between the base of the LED lens and the first lead bend. (Fig. 5 and 6)

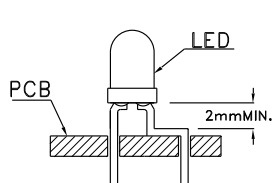

Fig. 5

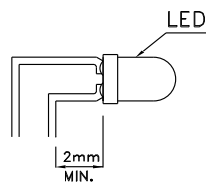

Fig. 6

2. Lead forming or bending must be performed before soldering, never during or after Soldering.
3. Do not stress the LED lens during lead-forming in order to fractures in the lens epoxy and damage the internal structures.
4. During lead forming, use tools or jigs to hold the leads securely so that the bending force will not be transmitted to the LED lens and its internal structures. Do not perform lead forming once the component has been mounted onto the PCB. (Fig. 7)
5. Do not bend the leads more than twice. (Fig. 8)

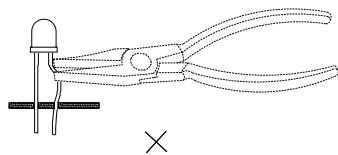

Fig. 7

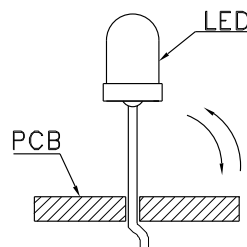

Fig. 8

6. After soldering or other high-temperature assembly, allow the LED to cool down to 50°C before applying outside force (Fig. 9). In general, avoid placing excess force on the LED to avoid damage. For any questions please consult with Kingbright representative for proper handling procedures.

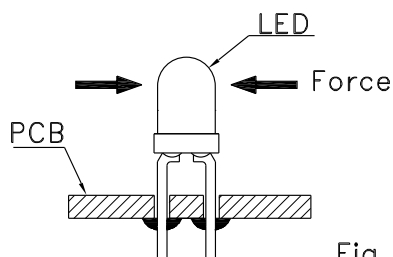

Fig. 9