

SERIES ULS-2800H AND ULS-2800R

HIGH-VOLTAGE, HIGH-CURRENT DARLINGTON ARRAYS

MIL-STD-883 Compliant

FEATURES

- TTL, DTL, PMOS, or CMOS Compatible Inputs
- Peak Output Current to 600 mA
- Transient-Protected Outputs
- Side-Brazed Hermetic Package
- Cer-DIP Hermetic Package
- High-Reliability Screening to MIL-STD-883, Class B
- -55°C to +125°C Temperature Range

DESIGNED TO SERVE as interface between low-level logic circuitry and high-power loads, Series ULS-2800H and ULS-2800R arrays consist of eight silicon NPN Darlington power drivers on a common monolithic substrate. They are ideally suited to driving relays, solenoids, lamps, and other devices in high-reliability military or aerospace applications with up to 3 A output current per package.

These devices are screened to MIL-STD-883, Class B and are supplied in either the popular glass/metal side-brazed 18-pin hermetic package (suffix 'H') or ceramic/glass cer-DIP hermetic package (suffix 'R'). Both package styles conform to the dimensional requirements of MIL-M-38510 and are rated for operation over the full military temperature range of -55°C to +125°C. Reverse-bias burn-in and 100% high-reliability screening are standard.

The 30 integrated circuits described in this bulletin permit the circuit designer to select the optimal device for any application. In addition to the two package styles, there are five input characteristics, two output-voltage ratings, and two output-current ratings. The appropriate part for specific applications can be determined from the Device Part Number Designation chart. All units have open-collector outputs and on-chip diodes for inductive-load transient suppression.

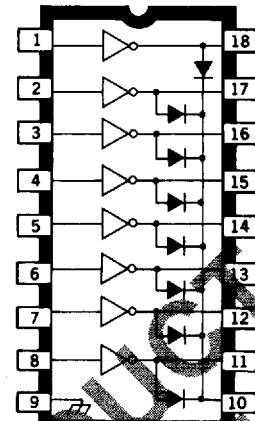

Dwg. No. A-11-22

Device Part Number Designation

$V_{CE(MAX)}$	50 V	50 V	95 V
$I_{C(MAX)}$	500 mA	600 mA	500 mA

	Part Number		
General Purpose PMOS, CMOS	ULS-2801*	ULS-2811*	ULS-2821*
14-25 V PMOS	ULS-2802*	ULS-2812*	ULS-2822*
5 V TTL, CMOS	ULS-2803*	ULS-2813*	ULS-2823*
6-15 V CMOS, PMOS	ULS-2804*	ULS-2814*	ULS-2824*
High-Output TTL	ULS-2805*	ULS-2815*	ULS-2825*

*Complete part number includes a final letter to indicate package (H = glass/metal side-brazed, R = ceramic/glass cer-DIP)

SERIES ULS-2800H AND ULS-2800R HIGH-VOLTAGE, HIGH-CURRENT DARLINGTON ARRAYS

ABSOLUTE MAXIMUM RATINGS

Output Voltage, V_{CE}	
(ULS-280X*, ULS-281X*)	50 V
(ULS-282X*)	95 V
Input Voltage, V_{IN}	
(ULS-28X2, X3, X4*)	30 V
(ULS-28X5*)	15 V
Peak Output Current, I_{OUT}	
(ULS-280X*, ULS-282X*)	500 mA
(ULS-281X*)	600 mA
Ground Terminal Current, I_{GND}	3.0 A
Continuous Input Current, I_{IN}	25 mA
Power Dissipation, P_D	
(one Darlington pair)	1.0 W
(total package)	See Graph
Operating Temperature Range, T_A	-55°C to +125°C
Storage Temperature Range, T_S	-65°C to +150°C

ALLOWABLE PACKAGE POWER DISSIPATION

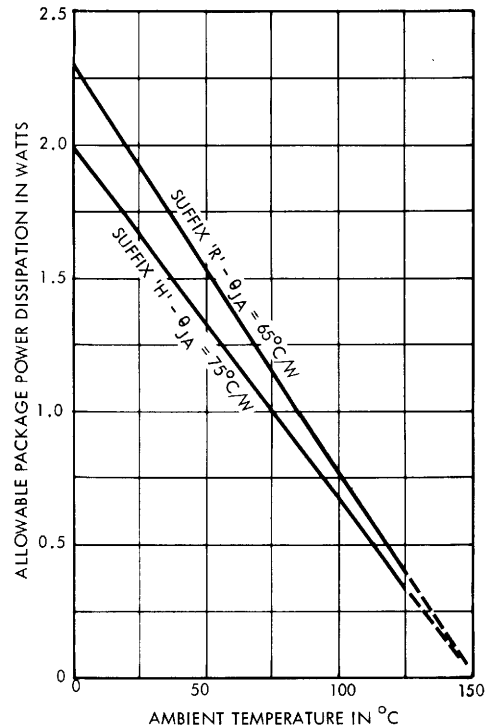

Dwg. No. A-10,879A

PARTIAL SCHEMATICS

ULS-28X1*
(Each Driver)

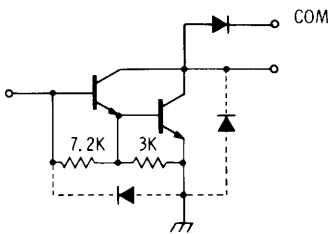

Dwg. No. A-9595

ULS-28X2*
(Each Driver)

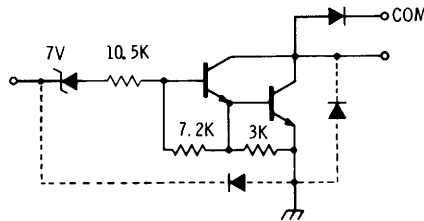

DWG. No. A-9650

Dwg. No. A-9650

ULS-28X3*
(Each Driver)

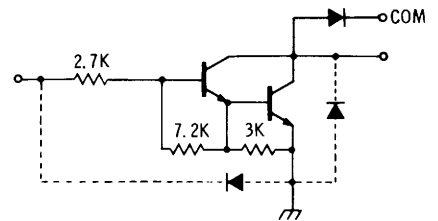

DWG. No. A-9651

Dwg. No. A-9651

ULS-28X4*
(Each Driver)

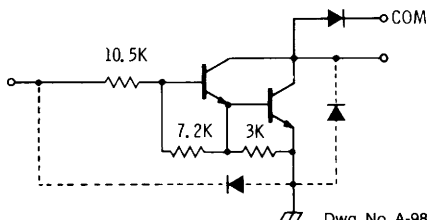

Dwg. No. A-9898A

ULS-28X5*
(Each Driver)

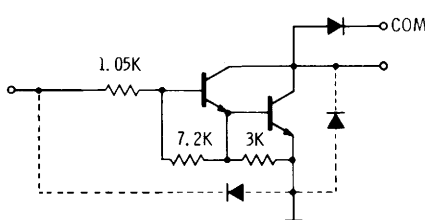

Dwg. No. A-10,228

*Complete part number includes a final letter to indicate package (H = glass/metal side-brazed, R = ceramic/glass cer-DIP).
X = digit to identify specific device. Specification or limit shown applies to family of devices with remaining digits as shown.

SERIES ULS-2800H AND ULS-2800R

ELECTRICAL CHARACTERISTICS over operating temperature range (unless otherwise noted)

Characteristic	Symbol	Applicable Devices	Test Conditions			Limits			
			Temp.	Voltage/Current	Fig.	Min.	Typ.	Max.	Units
Output Leakage Current	I_{CEX}	All		$V_{CE} = 50\text{ V}$	1A	—	—	100	μA
		ULS-2802*		$V_{CE} = 50\text{ V}, V_{IN} = 6\text{ V}$	1B	—	—	500	μA
		ULS-2804*		$V_{CE} = 50\text{ V}, V_{IN} = 1\text{ V}$	1B	—	—	500	μA
Collector-Emitter Saturation Voltage	$V_{CE(SAT)}$	All	- 55°C	$I_C = 350\text{ mA}, I_B = 850\ \mu\text{A}$	2	—	1.6	1.8	V
				$I_C = 200\text{ mA}, I_B = 550\ \mu\text{A}$	2	—	1.3	1.5	V
				$I_C = 100\text{ mA}, I_B = 350\ \mu\text{A}$	2	—	1.1	1.3	V
			+ 25°C	$I_C = 350\text{ mA}, I_B = 500\ \mu\text{A}$	2	—	1.25	1.6	V
				$I_C = 200\text{ mA}, I_B = 350\ \mu\text{A}$	2	—	1.1	1.3	V
				$I_C = 100\text{ mA}, I_B = 250\ \mu\text{A}$	2	—	0.9	1.1	V
			+ 125°C	$I_C = 350\text{ mA}\dagger, I_B = 500\ \mu\text{A}$	2	—	1.6	1.8	V
				$I_C = 200\text{ mA}, I_B = 350\ \mu\text{A}$	2	—	1.3	1.5	V
				$I_C = 100\text{ mA}, I_B = 250\ \mu\text{A}$	2	—	1.1	1.3	V
Input Current	$I_{IN(ON)}$	ULS-2802*		$V_{IN} = 17\text{ V}$	3	480	850	1300	μA
		ULS-2803*		$V_{IN} = 3.85\text{ V}$	3	650	930	1350	μA
		ULS-2804*		$V_{IN} = 5.0\text{ V}$	3	240	350	500	μA
				$V_{IN} = 12\text{ V}$	3	650	1000	1450	μA
		ULS-2805*		$V_{IN} = 3.0\text{ V}$	3	—	1500	2400	μA
Input Voltage	$V_{IN(OFF)}$	All	+ 125°C	$I_C = 500\ \mu\text{A}$	4	25	50	—	μA
		ULS-2802*	- 55°C	$V_{CE} = 2.0\text{ V}, I_C = 300\text{ mA}$	5	—	—	18	V
+ 125°C	$V_{CE} = 2.0\text{ V}, I_C = 300\text{ mA}$			5	—	—	13	V	
ULS-2803*	- 55°C		$V_{CE} = 2.0\text{ V}, I_C = 200\text{ mA}$	5	—	—	3.3	V	
			$V_{CE} = 2.0\text{ V}, I_C = 250\text{ mA}$	5	—	—	3.6	V	
			$V_{CE} = 2.0\text{ V}, I_C = 300\text{ mA}$	5	—	—	3.9	V	
+ 125°C	$V_{CE} = 2.0\text{ V}, I_C = 200\text{ mA}\dagger$		5	—	—	2.4	V		
	$V_{CE} = 2.0\text{ V}, I_C = 250\text{ mA}\dagger$		5	—	—	2.7	V		
	$V_{CE} = 2.0\text{ V}, I_C = 300\text{ mA}\dagger$		5	—	—	3.0	V		
ULS-2804*	- 55°C		$V_{CE} = 2.0\text{ V}, I_C = 125\text{ mA}$	5	—	—	6.0	V	
			$V_{CE} = 2.0\text{ V}, I_C = 200\text{ mA}$	5	—	—	8.0	V	
			$V_{CE} = 2.0\text{ V}, I_C = 275\text{ mA}$	5	—	—	10	V	
	+ 125°C		$V_{CE} = 2.0\text{ V}, I_C = 350\text{ mA}$	5	—	—	12	V	
			$V_{CE} = 2.0\text{ V}, I_C = 125\text{ mA}$	5	—	—	5.0	V	
			$V_{CE} = 2.0\text{ V}, I_C = 200\text{ mA}\dagger$	5	—	—	6.0	V	
ULS-2805*	- 55°C		$V_{CE} = 2.0\text{ V}, I_C = 275\text{ mA}\dagger$	5	—	—	7.0	V	
			$V_{CE} = 2.0\text{ V}, I_C = 350\text{ mA}\dagger$	5	—	—	8.0	V	
			$V_{CE} = 2.0\text{ V}, I_C = 350\text{ mA}\dagger$	5	—	—	3.0	V	
+ 125°C	$V_{CE} = 2.0\text{ V}, I_C = 350\text{ mA}\dagger$		5	—	—	2.4	V		
D-C Forward Current Transfer Ratio	h_{FE}	ULS2801*	- 55°C	$V_{CE} = 2.0\text{ V}, I_C = 350\text{ mA}$	2	500	—	—	—
			+ 25°C	$V_{CE} = 2.0\text{ V}, I_C = 350\text{ mA}$	2	1000	—	—	—
Turn-On Delay	t_{PLH}	All	+ 25°C		8	—	250	1000	ns
Turn-Off Delay	t_{PHL}	All	+ 25°C		8	—	250	1000	ns
Clamp Diode Leakage Current	I_R	All		$V_R = 50\text{ V}$	6	—	—	50	μA
Clamp Diode Forward Voltage	V_f	All		$I_f = 350\text{ mA}\dagger$	7	—	1.7	2.0	V

*Complete part number includes a final letter to indicate package (H = glass/metal side-brazed, R = ceramic/glass cer-DIP).

Note 1: All limits stated apply to the complete Darlington series except as specified for a single device type.

Note 2: The $I_{IN(OFF)}$ current limit guarantees against partial turn-on of the output.

Note 3: The $V_{IN(ON)}$ voltage limit guarantees a minimum output sink current per the specified test conditions.

†Pulse Test, $t_p \leq 1\ \mu\text{s}$, see graph.

**SERIES ULS-2800H AND ULS-2800R
HIGH-VOLTAGE, HIGH-CURRENT DARLINGTON ARRAYS**

SERIES ULS-2810H AND ULS-2810R

ELECTRICAL CHARACTERISTICS over operating temperature range (unless otherwise noted)

Characteristic	Symbol	Applicable Devices	Test Conditions			Limits			
			Temp.	Voltage/Current	Fig.	Min.	Typ.	Max.	Units
Output Leakage Current	I_{CEX}	All		$V_{CE} = 50\text{ V}$	1A	—	—	100	μA
		ULS-2812*		$V_{CE} = 50\text{ V}, V_{IN} = 6\text{ V}$	1B	—	—	500	μA
		ULS-2814*		$V_{CE} = 50\text{ V}, V_{IN} = 1\text{ V}$	1B	—	—	500	μA
Collector-Emitter Saturation Voltage	$V_{CE(SAT)}$	All	-55°C	$I_C = 500\text{ mA}, I_B = 1100\ \mu\text{A}$	2	—	1.8	2.1	V
				$I_C = 350\text{ mA}, I_B = 850\ \mu\text{A}$	2	—	1.6	1.8	V
				$I_C = 200\text{ mA}, I_B = 550\ \mu\text{A}$	2	—	1.3	1.5	V
			+25°C	$I_C = 500\text{ mA}, I_B = 600\ \mu\text{A}$	2	—	1.7	1.9	V
				$I_C = 350\text{ mA}, I_B = 500\ \mu\text{A}$	2	—	1.25	1.6	V
				$I_C = 200\text{ mA}, I_B = 350\ \mu\text{A}$	2	—	1.1	1.3	V
			+125°C	$I_C = 500\text{ mA}^\dagger, I_B = 600\ \mu\text{A}$	2	—	1.8	2.1	V
				$I_C = 350\text{ mA}^\dagger, I_B = 500\ \mu\text{A}$	2	—	1.6	1.8	V
				$I_C = 200\text{ mA}, I_B = 350\ \mu\text{A}$	2	—	1.3	1.5	V
Input Current	$I_{IN(ON)}$	ULS-2812*		$V_{IN} = 17\text{ V}$	3	480	850	1300	μA
		ULS-2813*		$V_{IN} = 3.85\text{ V}$	3	650	930	1350	μA
		ULS-2814*		$V_{IN} = 5.0\text{ V}$	3	240	350	500	μA
				$V_{IN} = 12\text{ V}$	3	650	1000	1450	μA
		ULS-2815*		$V_{IN} = 3.0\text{ V}$	3	—	1500	2400	μA
	$I_{IN(OFF)}$	All	+125°C	$I_C = 500\ \mu\text{A}$	4	25	50	—	μA
Input Voltage	$V_{IN(ON)}$	ULS-2812*	-55°C	$V_{CE} = 2.0\text{ V}, I_C = 500\text{ mA}$	5	—	—	23.5	V
			+125°C	$V_{CE} = 2.0\text{ V}, I_C = 500\text{ mA}$	5	—	—	17	V
		ULS-2013*	-55°C	$V_{CE} = 2.0\text{ V}, I_C = 250\text{ mA}$	5	—	—	3.6	V
				$V_{CE} = 2.0\text{ V}, I_C = 300\text{ mA}$	5	—	—	3.9	V
				$V_{CE} = 2.0\text{ V}, I_C = 500\text{ mA}$	5	—	—	6.0	V
			+125°C	$V_{CE} = 2.0\text{ V}, I_C = 250\text{ mA}^\dagger$	5	—	—	2.7	V
				$V_{CE} = 2.0\text{ V}, I_C = 300\text{ mA}^\dagger$	5	—	—	3.0	V
				$V_{CE} = 2.0\text{ V}, I_C = 500\text{ mA}^\dagger$	5	—	—	3.5	V
		ULS-2814*	-55°C	$V_{CE} = 2.0\text{ V}, I_C = 275\text{ mA}$	5	—	—	10	V
				$V_{CE} = 2.0\text{ V}, I_C = 350\text{ mA}$	5	—	—	12	V
				$V_{CE} = 2.0\text{ V}, I_C = 500\text{ mA}$	5	—	—	17	V
			+125°C	$V_{CE} = 2.0\text{ V}, I_C = 275\text{ mA}^\dagger$	5	—	—	7.0	V
				$V_{CE} = 2.0\text{ V}, I_C = 350\text{ mA}^\dagger$	5	—	—	8.0	V
				$V_{CE} = 2.0\text{ V}, I_C = 500\text{ mA}^\dagger$	5	—	—	9.5	V
		ULS-2815*	-55°C	$V_{CE} = 2.0\text{ V}, I_C = 350\text{ mA}$	5	—	—	3.0	V
				$V_{CE} = 2.0\text{ V}, I_C = 500\text{ mA}$	5	—	—	3.5	V
			+125°C	$V_{CE} = 2.0\text{ V}, I_C = 350\text{ mA}^\dagger$	5	—	—	2.4	V
				$V_{CE} = 2.0\text{ V}, I_C = 500\text{ mA}^\dagger$	5	—	—	2.6	V
D-C Forward Current Transfer Ratio	h_{FE}	ULS-2811*	-55°C	$V_{CE} = 2.0\text{ V}, I_C = 500\text{ mA}$	2	450	—	—	—
			+25°C	$V_{CE} = 2.0\text{ V}, I_C = 500\text{ mA}$	2	900	—	—	—
Turn-On Delay	t_{PLH}	All	+25°C		8	—	250	1000	ns
Turn-Off Delay	t_{PHL}	All	+25°C		8	—	250	1000	ns
Clamp Diode Leakage Current	I_R	All		$V_R = 50\text{ V}$	6	—	—	50	μA
Clamp Diode Forward Voltage	V_f	All		$I_f = 350\text{ mA}^\dagger$	7	—	1.7	2.0	V
				$I_f = 500\text{ mA}^\dagger$	7	—	—	2.5	V

*Complete part number includes a final letter to indicate package (H = glass/metal side-brazed, R = ceramic/glass cer-DIP).

Note 1: All limits stated apply to the complete Darlington series except as specified for a single device type.

Note 2: The $I_{IN(OFF)}$ current limit guarantees against partial turn-on of the output.

Note 3: The $V_{IN(ON)}$ voltage limit guarantees a minimum output sink current per the specified test conditions.

†Pulse Test, $t_p \leq 1\ \mu\text{s}$, see graph.

SERIES ULS-2820H AND ULS-2820R
ELECTRICAL CHARACTERISTICS over operating temperature range (unless otherwise noted)

Characteristic	Symbol	Applicable Devices	Test Conditions			Limits					
			Temp.	Voltage/Current	Fig.	Min.	Typ.	Max.	Units		
Output Leakage Current	I_{CEX}	All		$V_{CE} = 95\text{ V}$	1A	—	—	100	μA		
		ULS-2822*		$V_{CE} = 95\text{ V}, V_{IN} = 6\text{ V}$	1B	—	—	500	μA		
		ULS-2824*	25°C	$V_{CE} = 95\text{ V}, V_{IN} = 1\text{ V}$	1B	—	—	500	μA		
			+125°C	$V_{CE} = 95\text{ V}, V_{IN} = 0.5\text{ V}$	1B	—	—	500	μA		
Collector-Emitter Saturation Voltage	$V_{CE(SAT)}$	All	-55°C	$I_C = 350\text{ mA}, I_B = 850\ \mu\text{A}$	2	—	1.6	1.8	V		
				$I_C = 200\text{ mA}, I_B = 550\ \mu\text{A}$	2	—	1.3	1.5	V		
				$I_C = 100\text{ mA}, I_B = 350\ \mu\text{A}$	2	—	1.1	1.3	V		
			+25°C	$I_C = 350\text{ mA}, I_B = 500\ \mu\text{A}$	2	—	1.25	1.6	V		
				$I_C = 200\text{ mA}, I_B = 350\ \mu\text{A}$	2	—	1.1	1.3	V		
				$I_C = 100\text{ mA}, I_B = 250\ \mu\text{A}$	2	—	0.9	1.1	V		
			+125°C	$I_C = 350\text{ mA}\dagger, I_B = 500\ \mu\text{A}$	2	—	1.6	1.8	V		
				$I_C = 200\text{ mA}, I_B = 350\ \mu\text{A}$	2	—	1.3	1.5	V		
				$I_C = 100\text{ mA}, I_B = 250\ \mu\text{A}$	2	—	1.1	1.3	V		
Input Current	$I_{IN(ON)}$	ULS-2822*		$V_{IN} = 17\text{ V}$	3	480	850	1300	μA		
		ULS-2823*		$V_{IN} = 3.85\text{ V}$	3	650	930	1350	μA		
		ULS-2824*		$V_{IN} = 5.0\text{ V}$	3	240	350	500	μA		
				$V_{IN} = 12\text{ V}$	3	650	1000	1450	μA		
		ULS-2825*		$V_{IN} = 3.0\text{ V}$	3	—	1500	2400	μA		
	$I_{IN(OFF)}$	All	+125°C	$I_C = 500\ \mu\text{A}$	4	20	50	—	μA		
Input Voltage	$V_{IN(ON)}$	ULS-2822*	-55°C	$V_{CE} = 2.0\text{ V}, I_C = 300\text{ mA}$	5	—	—	18	V		
			+125°C	$V_{CE} = 2.0\text{ V}, I_C = 300\text{ mA}$	5	—	—	13	V		
		ULS-2823*	-55°C	$V_{CE} = 2.0\text{ V}, I_C = 200\text{ mA}$	5	—	—	3.3	V		
				$V_{CE} = 2.0\text{ V}, I_C = 250\text{ mA}$	5	—	—	3.6	V		
				$V_{CE} = 2.0\text{ V}, I_C = 300\text{ mA}$	5	—	—	3.9	V		
			+125°C	$V_{CE} = 2.0\text{ V}, I_C = 200\text{ mA}\dagger$	5	—	—	2.4	V		
				$V_{CE} = 2.0\text{ V}, I_C = 250\text{ mA}\dagger$	5	—	—	2.7	V		
				$V_{CE} = 2.0\text{ V}, I_C = 300\text{ mA}\dagger$	5	—	—	3.0	V		
		ULS-2824*	-55°C	$V_{CE} = 2.0\text{ V}, I_C = 125\text{ mA}$	5	—	—	6.0	V		
				$V_{CE} = 2.0\text{ V}, I_C = 200\text{ mA}$	5	—	—	8.0	V		
				$V_{CE} = 2.0\text{ V}, I_C = 275\text{ mA}$	5	—	—	10	V		
				$V_{CE} = 2.0\text{ V}, I_C = 350\text{ mA}$	5	—	—	12	V		
			+125°C	$V_{CE} = 2.0\text{ V}, I_C = 125\text{ mA}$	5	—	—	5.0	V		
				$V_{CE} = 2.0\text{ V}, I_C = 200\text{ mA}\dagger$	5	—	—	6.0	V		
				$V_{CE} = 2.0\text{ V}, I_C = 275\text{ mA}\dagger$	5	—	—	7.0	V		
				$V_{CE} = 2.0\text{ V}, I_C = 350\text{ mA}\dagger$	5	—	—	8.0	V		
		ULS-2825*	-55°C	$V_{CE} = 2.0\text{ V}, I_C = 350\text{ mA}$	5	—	—	3.0	V		
			+125°C	$V_{CE} = 2.0\text{ V}, I_C = 350\text{ mA}\dagger$	5	—	—	2.4	V		
		D-C Forward Current Transfer Ratio	h_{FE}	ULS2821*	-55°C	$V_{CE} = 2.0\text{ V}, I_C = 350\text{ mA}$	2	500	—	—	—
					+25°C	$V_{CE} = 2.0\text{ V}, I_C = 350\text{ mA}$	2	1000	—	—	—
Turn-On Delay	t_{PLH}	All	+25°C		8	—	250	1000	ns		
Turn-Off Delay	t_{PHL}	All	+25°C		8	—	250	1000	ns		
Clamp Diode Leakage Current	I_R	All		$V_R = 95\text{ V}$	6	—	—	50	μA		
Clamp Diode Forward Voltage	V_f	All		$I_f = 350\text{ mA}\dagger$	7	—	1.7	2.0	V		

*Complete part number includes a final letter to indicate package (H = glass/metal side-brazed, R = ceramic/glass cer-DIP).

Note 1: All limits stated apply to the complete Darlington series except as specified for a single device type.

Note 2: The $I_{IN(OFF)}$ current limit guarantees against partial turn-on of the output.

Note 3: The $V_{IN(ON)}$ voltage limit guarantees a minimum output sink current per the specified test conditions.

†Pulse Test, $t_p \leq 1\ \mu\text{s}$, see graph.

TEST FIGURES

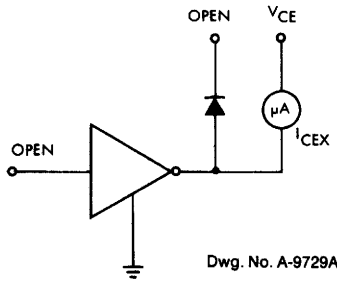

FIGURE 1A

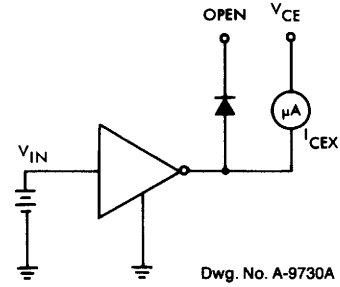

FIGURE 1B

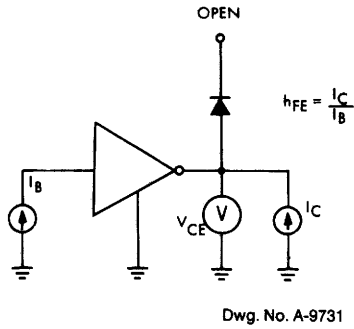

FIGURE 2

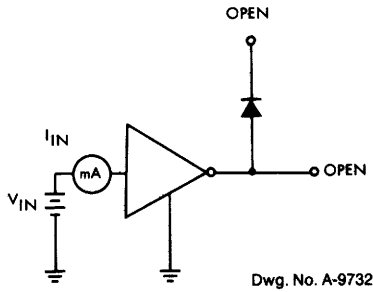

FIGURE 3

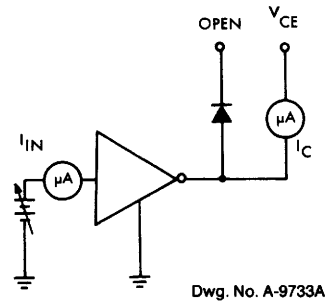

FIGURE 4

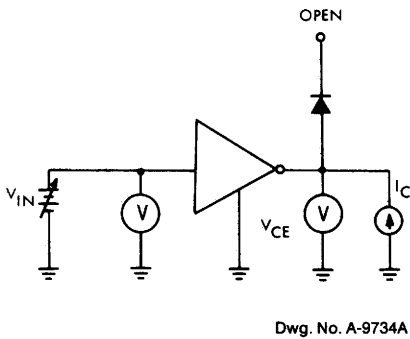

FIGURE 5

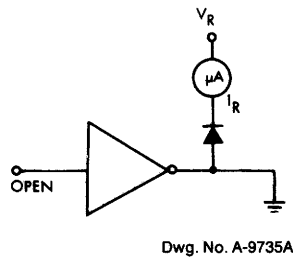

FIGURE 6

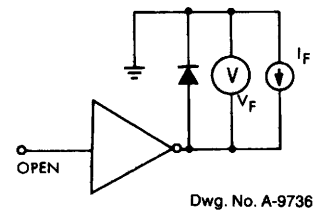
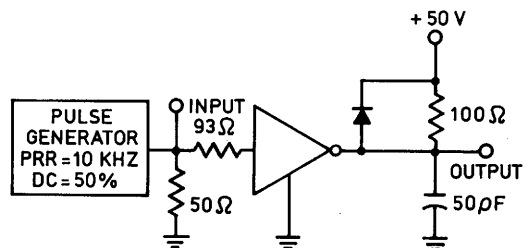

FIGURE 7

**SERIES ULS-2800H AND ULS-2800R
HIGH-VOLTAGE, HIGH-CURRENT DARLINGTON ARRAYS**

	V_{in}
ULS-28X1*	3.5 V
ULS-28X2*	13 V
ULS-28X3*	3.5 V
ULS-28X4*	12 V
ULS-28X5*	3.5 V



Dwg. No. A-13,273

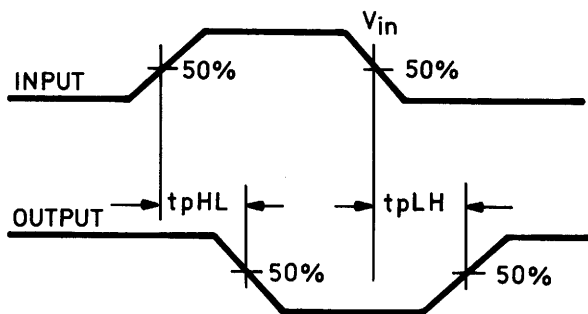

Dwg. No. A-13,272

* Complete part number includes a final letter to indicate package.
X = Digit to identify specific device. Specification shown applies to family of devices with remaining digits as shown.

FIGURE 8

**COLLECTOR CURRENT
AS A FUNCTION OF SATURATION VOLTAGE**

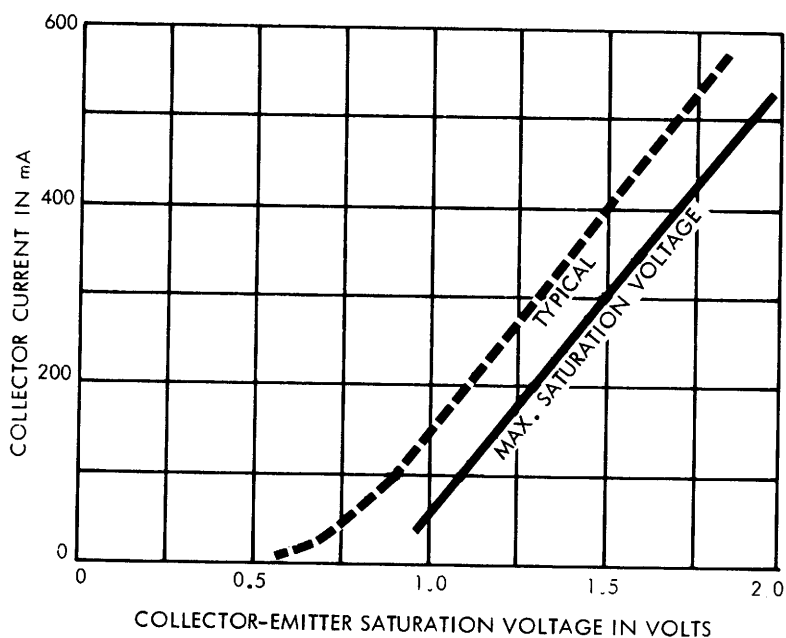

Dwg. No. A-9754C

**COLLECTOR CURRENT
AS A FUNCTION OF INPUT CURRENT**

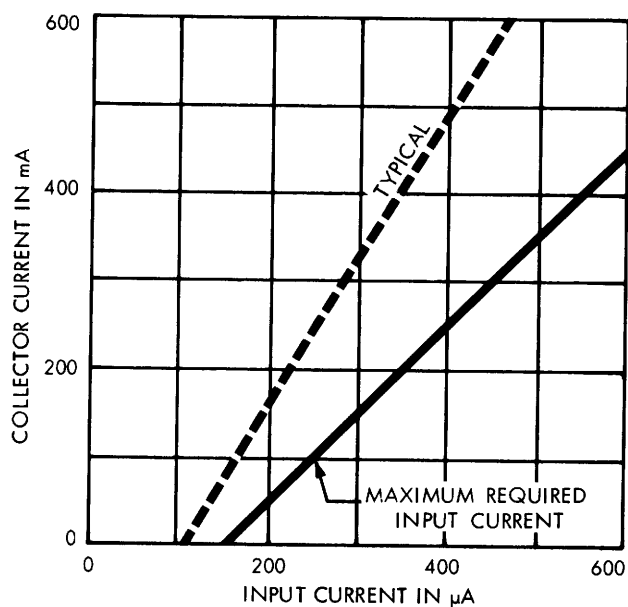

Dwg. No. A-10,872B

SERIES ULS-2800H

**PEAK COLLECTOR CURRENT
AS A FUNCTION OF DUTY CYCLE AT +50°C**

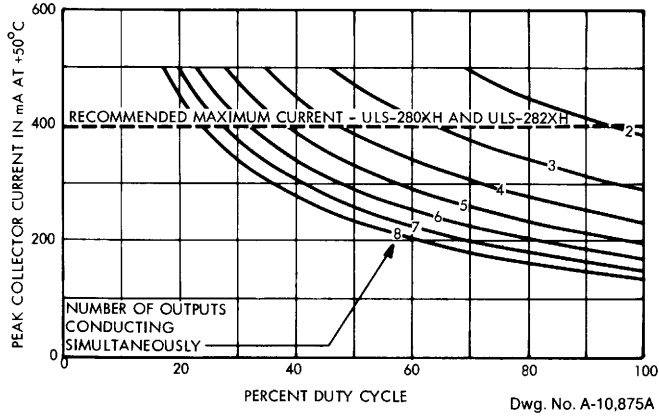

**PEAK COLLECTOR CURRENT
AS A FUNCTION OF DUTY CYCLE AT +75°C**

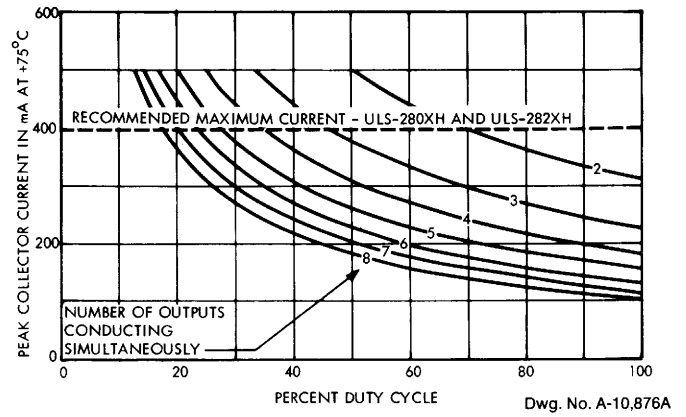

**PEAK COLLECTOR CURRENT
AS A FUNCTION OF DUTY CYCLE AT +100°C**

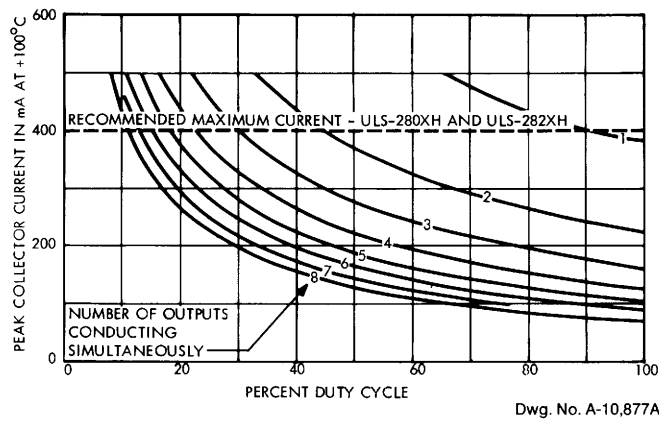

**PEAK COLLECTOR CURRENT
AS A FUNCTION OF DUTY CYCLE AT +125°C**

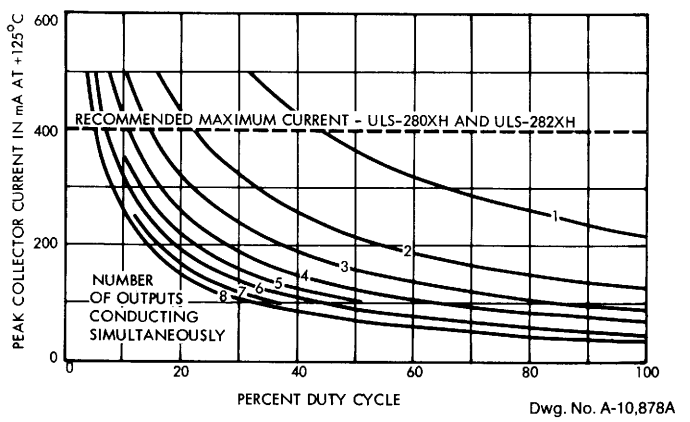

X = digit to identify specific device. Specification or limit shown applies to family of devices with remaining digits as shown.

SERIES ULS-2800R

**PEAK COLLECTOR CURRENT
AS A FUNCTION OF DUTY CYCLE AT +50°C**

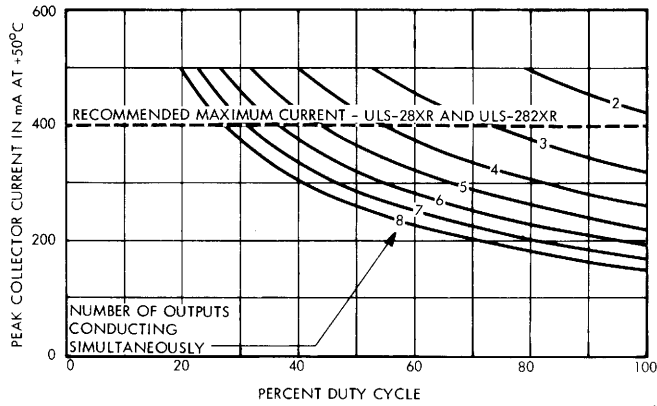

Dwg. No. A-10,870A

**PEAK COLLECTOR CURRENT
AS A FUNCTION OF DUTY CYCLE AT +75°C**

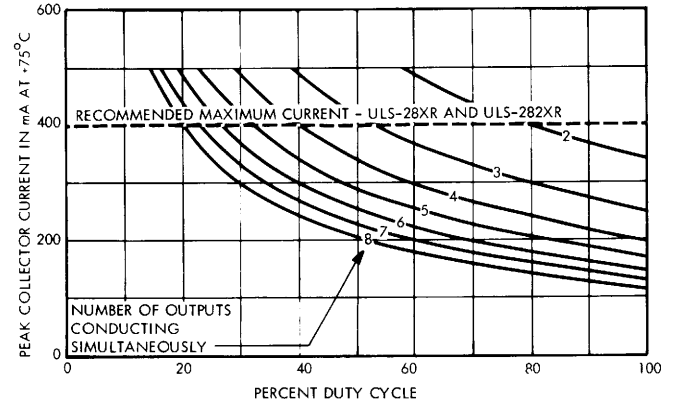

Dwg. No. A-10,871A

**PEAK COLLECTOR CURRENT
AS A FUNCTION OF DUTY CYCLE AT +100°C**

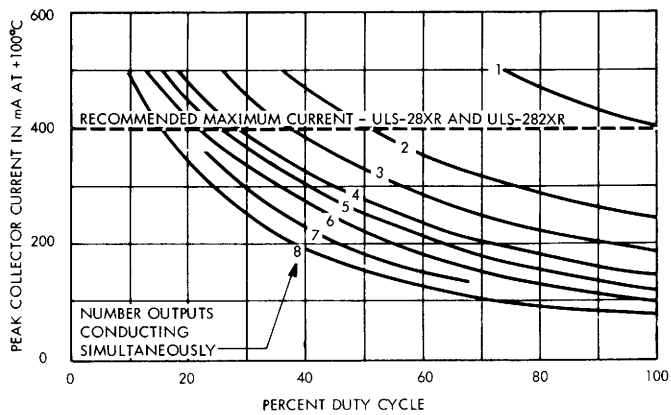

Dwg. No. A-12,466

**PEAK COLLECTOR CURRENT
AS A FUNCTION OF DUTY CYCLE AT +125°C**

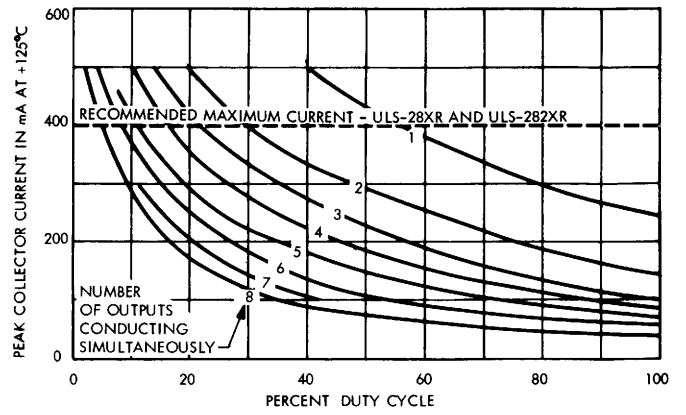

Dwg. No. A-12,467

X = digit to identify specific device. Specification or limit shown applies to family of devices with remaining digits as shown.

INPUT CURRENT AS A FUNCTION OF INPUT VOLTAGE

ULS-28X2

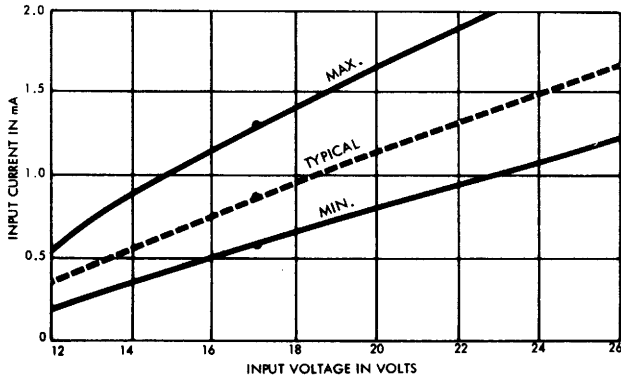

Dwg. No. A-10,225A

ULS-28X3

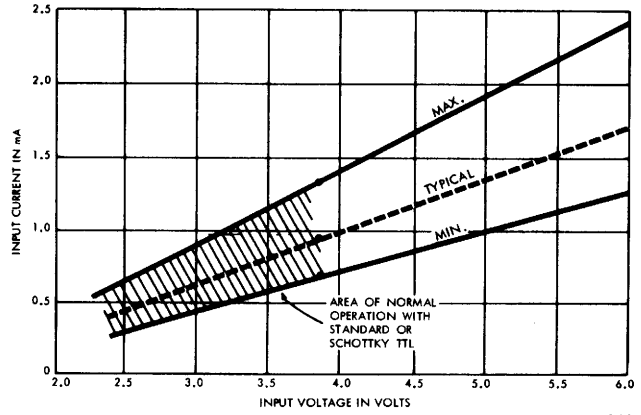

Dwg. No. A-10,224A

ULS-28X4

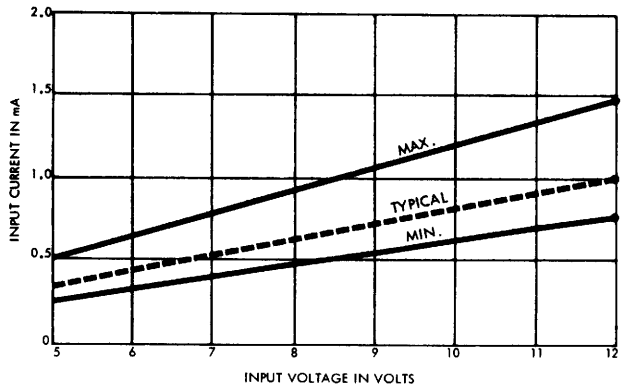

Dwg. No. A-10,226A

ULS-28X5

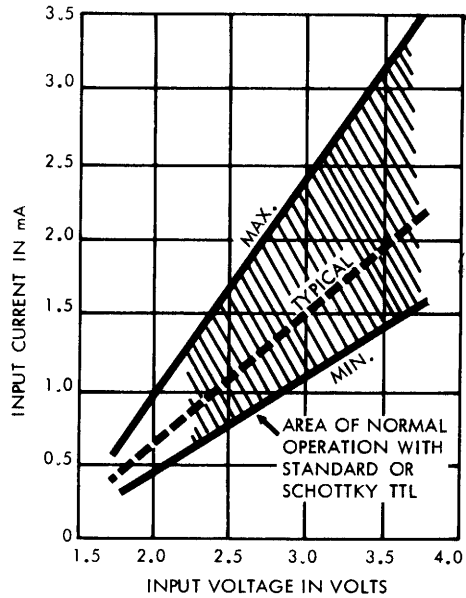

Dwg. No. A-10,874A

X = digit to identify specific device. Specification or limit shown applies to family of devices with remaining digits as shown.

HERMETIC GLASS/METAL 'H' PACKAGE

DIMENSIONS IN INCHES

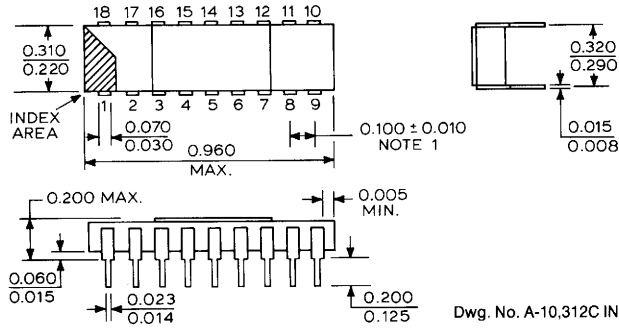

DIMENSIONS IN MILLIMETERS

Based on 1" = 25.4 mm

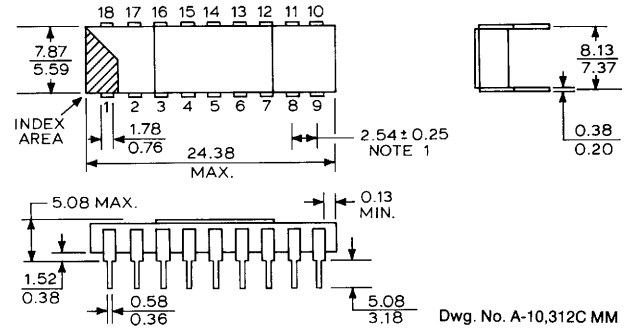

This package conforms to military specification MIL-M-38510, case outline D-6, configuration 3. Devices using this package are marked to indicate compliance to the latest issue of MIL-STD-883. For example: ULS2801H-883.

HERMETIC CERAMIC/GLASS 'R' PACKAGE

DIMENSIONS IN INCHES

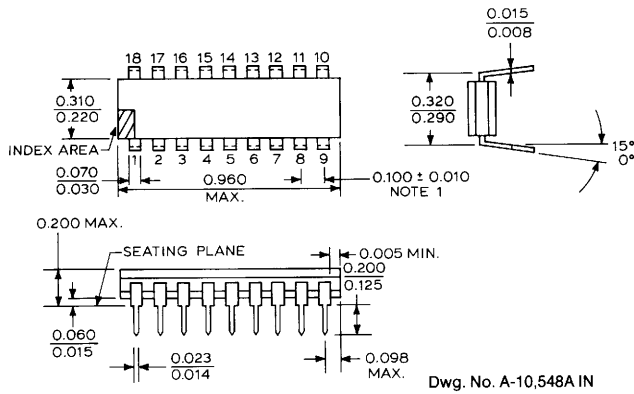

DIMENSIONS IN MILLIMETERS

Based on 1" = 25.4 mm

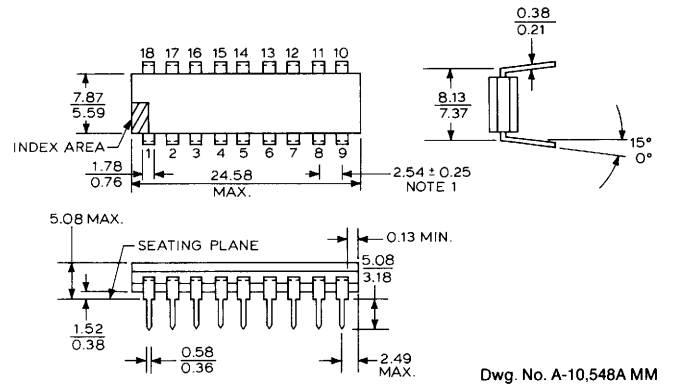

This package conforms to military specification MIL-M-38510, case outline D-6, configuration 1. Devices using this package are marked to indicate compliance to the latest issue of MIL-STD-883. For example: ULS2803R-883.

NOTES:

1. Lead spacing tolerance is non-cumulative.
2. Exact body and lead configuration at vendor's option within limits shown.
3. Lead gauge plane is 0.030 in. (0.76 mm) max. below seating plane.

SALES OFFICES

UNITED STATES

ALABAMA
EPI Inc.
Suite 13 — 9694 Hwy. 20 W
Madison 35758
Tel. 205/461-7000

Electramark Inc.
Suite 21
3322 South Memorial Parkway
Huntsville 35801
Tel. 205/883-9948

ARIZONA
Sprague Electric Company
Suite 209 — 1819 S. Dobson Rd.
Mesa 85202 — 5690
Tel. 602/244-0154
Tel. 602/831-6762

Sprague Electric Company
Suite 601
1150 E. Pennsylvania Street
Tucson 85714 — 1640
Tel. 602/746-0955

CALIFORNIA (Metro. L.A.)
Sprague Electric Company
Suite 150 — 3100 S. Harbor Blvd.
Santa Ana 92704
Tel. 714/549-9913

Sprague Electric Company
Suite 459
15350 Sherman Way
Van Nuys 91406
Tel. 818/994-6500

Sprague Electric Company
Suite 126
4300 Stevens Creek Boulevard
San Jose 95129 — 1249
Tel. 408/241-7111

(Northern)
William J. Purdy Company
770 Airport Blvd.
Burlingame 94010 — 1927
Tel. 415/347-7701

(San Diego)
Miner Associates, Inc.
Suite 117 — 10721 Treena Street
San Diego 92131 — 1009
Tel. 619/566-9891

COLORADO
William J. Purdy Company
5570 E. Yale Ave.
Denver 80222 — 6907
Tel. 303/753-6800

Todd & Fry Associates
P.O. Box 1689
Longmont 80502 — 1689
Tel. 303/776-7331

CONNECTICUT
Sprague Electric Company
88 Main Street South
Southbury 06488
Tel. 203/264-9595

Sprague Electric Company
120 Hartford Turnpike South
P.O. Box 578
Wallingford 06492 — 0578
Tel. 203/284-8300

Data Mark Inc.
47 Clapboard Hill Road
Guilford 06437 — 2261
Tel. 203/453-0575

DIST. OF COLUMBIA
Sprague Electric Company
Suite 311
14333 Laurel-Bowie Road
Laurel, MD 20708 — 1130
Tel. 301/953-1717

DIST. OF COLUMBIA (continued)
Trinkle Sales Inc.
P.O. Box 5320
Cherry Hill, NJ 08034 — 0460
Tel. 609/795-4200

FLORIDA
Sprague Electric Company
P.O. Box 1410
Altamonte Springs 32715 — 1410
Tel. 305/831-3636
Sprague Electric Company
Suite 419 — 1500 N.W. 62nd Street
Ft. Lauderdale 33309 — 1802
Tel. 305/491-7411

Sprague Electric Company
Suite T, Building 501
8001 North Dale Mabry
Tampa 33614 — 3265
Tel. 813/935-8203

GEORGIA
Electramark Inc.
6030 — I Unity Drive
Norcross 30071 — 3583
Tel. 404/446-7915

Electronic Marketing Associates
Suite 101
6695 Peachtree Industrial Blvd.
Atlanta 30360 — 2116
Tel. 404/448-1215

ILLINOIS (Northern)
Sprague Electric Company
Suite 410 — 1480 Renaissance Dr.
Park Ridge 60068 — 1386
Tel. 312/296-6620

(Southern)
EPI Inc.
Suite 201 — 103 W. Lockwood
St. Louis, MO 63119 — 2915
Tel. 314/962-1411

INDIANA
Sprague Electric Company
Suite 290 — 8200 Haverstick Road
Indianapolis 46240
Tel. 317/253-4247

IOWA
J. R. Sales Engineering, Inc.
1930 St. Andrews, N. E.
Cedar Rapids 52402
Tel. 319/393-2232

KANSAS
EPI Inc.
Suite 201 — 103 W. Lockwood
St. Louis, MO 63119 — 2915
Tel. 314/962-1411

KENTUCKY
Sprague Electric Company
821 Corporate Drive
Unit #16, Suite 200
Lexington 40503
Tel. 606/224-4230

MARYLAND
Sprague Electric Company
Suite 311
14333 Laurel-Bowie Road
Laurel 20708 — 1130
Tel. 301/792-4890
Trinkle Sales Inc.
P.O. Box 5320
Cherry Hill, NJ 08034 — 0460
Tel. 609/795-4200

MASSACHUSETTS
Sprague Electric Company
10 Burr St.
Framingham 01701 — 4617
Tel. 617/875-3200
Ray Perron & Co., Inc.
P.O. Box 389
Needham 02192 — 0009
Tel. 617/449-6162

MICHIGAN
Sprague Electric Company
Suite 301 — 2155 Jackson Road
Ann Arbor 48103 — 3917
Tel. 313/761-2014

MINNESOTA
HMR, Inc.
9065 Lyndale Ave. South
Minneapolis 55420 — 3520
Tel. 612/888-2122

MISSISSIPPI
EPI Inc.
Suite 13 — 9694 Hwy. 20 W
Madison, AL 35758
Tel. 205/461-7000

MISSOURI
EPI Inc.
Suite 201 — 103 W. Lockwood
St. Louis 63119 — 2915
Tel. 314/962-1411

NEBRASKA
J. R. Sales Engineering, Inc.
1930 St. Andrews, N. E.
Cedar Rapids, Iowa 52402
Tel. 319/393-2232

NEW HAMPSHIRE
Ray Perron & Co., Inc.
1 Elm St.
Dover 03820 — 3910
Tel. 603/742-2321

NEW JERSEY (Northern)
Sprague Electric Company
P.O. Box 1612
Wayne 07470 — 0701
Tel. 201/696-8200

(Southern)
Trinkle Sales Inc.
P.O. Box 5320
Cherry Hill 08034 — 0460
Tel. 609/795-4200

NEW MEXICO
William J. Purdy Company
120 LaVeta Drive NE
Albuquerque 87108 — 1613
Tel. 505/266-7959

NEW YORK (Downstate)
Sprague Electric Company
2001 Palmer Ave.
Larchmont 10538 — 2420
Tel. 914/834-4439

(Long Island)
Sprague Electric Company
P.O. Box 541
Central Islip 11722 — 0541
Tel. 516/234-8700

(Upstate)
Sprague Electric Company
2002 Teall Ave.
Syracuse 13206 — 1542
Tel. 315/437-7311

Paston-Hunter Co., Inc.
2002 Teall Ave.
Syracuse 13206 — 1596
Tel. 315/437-2843

NORTH CAROLINA
Sprague Electric Company
9741-M Southern Pine Blvd.
Charlotte 28210 — 5560
Tel. 704/527-1306

Electronic Marketing Associates
9225 Honeycutt Creek Rd.
Raleigh 27609 — 1523
Tel. 919/847-8800

OHIO
Sprague Electric Company
Suite 330 — 555 Metro Place North
Dublin 43017 — 1375
Tel. 614/761-1881

OREGON
Sprague Electric Company
Suite H
16111 S.E. McGillivray Boulevard
Vancouver, WA 98664 — 9025
Tel. 503/225-0493
Tel. 206/892-0361

OREGON (continued)
William J. Purdy Company
7799 Southwest Cirrus Drive
Beaverton 97005 — 5945
Tel. 503/641-9373

PENNSYLVANIA
Trinkle Sales Inc.
P.O. Box 5320
Cherry Hill, NJ 08034 — 0460
Tel. Phila. 215/922-2080

SOUTH CAROLINA
Electronic Marketing Associates
210 W. Stone Ave.
Greenville 29609 — 5499
Tel. 803/233-4637

TENNESSEE (Eastern)
Electronic Marketing Associates
9225 Honeycutt Creek Road
Raleigh, NC 27609 — 1523
Tel. 919/847-8800

(Western)
EPI Inc.
Suite 13 — 9694 Hwy. 20 W
Madison, AL 35758
Tel. 205/461-7000

TEXAS
Sprague Electric Company
Suite 220
9319 LBJ Freeway
Dallas 75243 — 3403
Tel. 214/235-1256

Sprague Electric Company
Suite 350W — 1106 Clayton Lane
Austin 78723 — 1033
Tel. 512/458-2514

UTAH
William J. Purdy Company
5570 E. Yale Avenue
Denver, CO 80222 — 6907
Tel. 303/753-6800

VIRGINIA
Sprague Electric Company
1 East Preston St.
Lexington 24450 — 2324
Tel. 703/463-9161

Sprague Electric Company
Suite 311
14333 Laurel-Bowie Road
Laurel, MD 20708 — 1130
Tel. 301/953-1717

Trinkle Sales Inc.
P.O. Box 5320
Cherry Hill, NJ 08034 — 0460
Tel. 609/795-4200

WASHINGTON
Sprague Electric Company
3826 Woodland Park, North
Seattle 98103 — 7996
Tel. 206/632-7761

Sprague Electric Company
Suite H
16111 S.E. McGillivray Blvd.
Vancouver 98664
Tel. 206/892-0361
Tel. 503/225-0493
William J. Purdy Company
4082-148th Ave. N.E.
Redmond 98052 — 5165
Tel. 206/882-3144

WISCONSIN
D. Dolin Sales
131 West Layton Ave.
Milwaukee 53207 — 5991
Tel. 414/482-1111

CANADA
Sprague Electric of Canada, Ltd.
Suite 220
2375 Steeles Avenue, W.
Downsview, Ontario M3J 3A8
Tel. 416/665-6066

CANADA (continued)
Sprague Electric of Canada, Ltd.
Suite 1610 — 85 Albert St.
Ottawa, Ont. K1P 6A4
Tel. 613/238-2542

Lenbrook Electronics
Suite No. 2
13696 104th Ave.
Surrey, B.C. V3T1W4
Tel. 604/585-9599

EUROPE
Sprague World Trade Corp.
18 Avenue Louis Casai
1209-Geneva
Switzerland
Tel. 98-4021
TLX 845-23469

Sprague Benelux
Excelsiorlaan 21
Bus 3
1930 Zaventem
Belgium
Tel. 02/721.48.60
TLX 62897

Sprague Electric (U.K.) Ltd.
Airtech No. 2
Fleming Way
Crawley West Sussex RH 102 YQ
England
Tel. 011-44-293-51-78-78
TLX 877813

Sprague France S.A.R.L.
3 Rue Camille Desmoulins
9430 Cachan
France
Tel. (1) 547-6600
TLX 250697

Sprague Elektronik GmbH
Postfach 700 848
D-6 Frankfurt/M
West Germany
Tel. 069-60551
TLX 414008

Sprague Italiana S.p.A.
Via G. DeCastro 4
20144 Milano
Italy
Tel. 02-498-7891
TLX 332321

Sprague Scandinavia AB
Box 54
S-182 71 Stocksund
Sweden
Tel. (04.) 08-8502 20
TLX 854 15239

FAR EAST
Sprague World Trade Corp.
Eastern Branch
G.P.O. Box 4289
Hong Kong
Tel. 0-283188
TLX 43395

Sprague Japan K.K.
Shinjuku KB Bldg.
11-3, Nishi-Shinjuku 6-Chome
Shinjuku-ku, Tokyo 160
Japan
Tel. (03) 348-5221
TLX J23328

Tecnomil Ltd.
Sprague Korea Branch
4th Fl., Daiyoung Bldg.,
44-1, Yoido-Dong
Youngdongpo-Ku, Seoul, Korea
Tel. (2) 783-9784
TLX 78726186

Sprague World Trade Corp.
Singapore Office
11th Floor, 450/452 Incheape House
Alexandra Road
Singapore 0511
Tel. 475-1826
TLX RS 26384

Sprague Taiwan Branch/
Tecnomil, Ltd.
8/F, 142, Sec. 4
Chung Hsiao East Road
Taipei, Taiwan, R.O.C.
Tel. 771-9582
TLX 21422

In the construction of the components described, the full intent of the specification will be met. The Sprague Electric Company, however, reserves the right to make, from time to time, such departures from the detail specifications as may be required to permit improvements in the design of its products. Components made under military approvals will be in accordance with the approval requirements.

The information included herein is believed to be accurate and reliable. However, the Sprague Electric Company assumes no responsibility for its use; nor for any infringements of patents or other rights which may result from its use.

8217
8439