

# MODULAR CONNECTORS

Dip Type

Straight Dip Type

CL 222 TM

● TM3R-6-※

HRS No.	Part No.
CL222-0114-3-10	TM3R-66(10)
CL222-0071-2-10	TM3R-64(10)

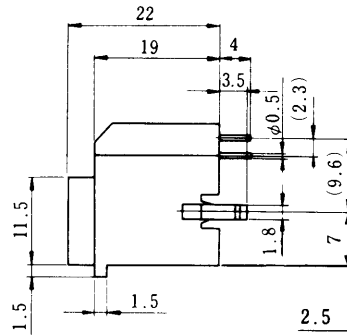
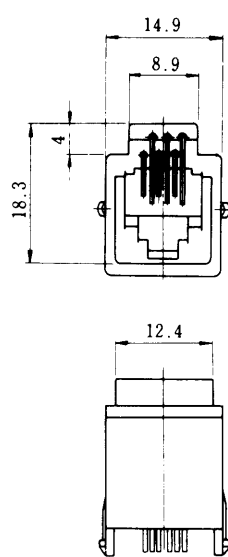
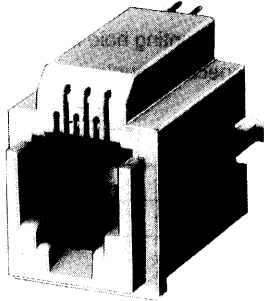

PCB mounting hole layout  
(Connector mounting side)

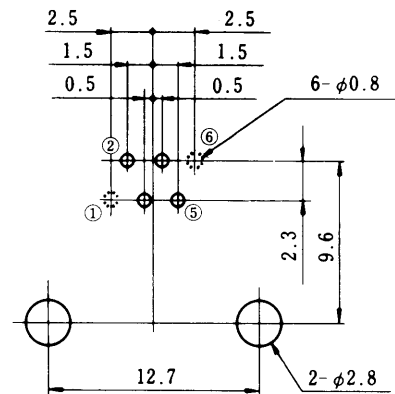

Note 1: Standard finish color is vanilla white.

Note 2: The drawing is shown sample of TM3R-66.

● TM3RA-※※

HRS No.	Part No.	A	B
CL222-0521-7	TM3RA-44	12.9	6.9
CL222-0567-8	TM3RA-62	14.9	8.9
CL222-0584-7	TM3RA-64	14.9	8.9
CL222-0770-1	TM3RA-66	14.9	8.9

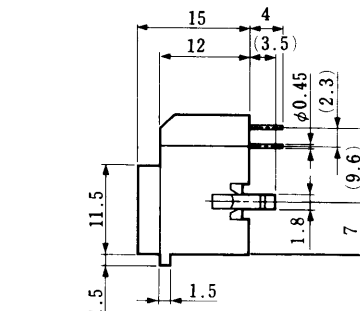
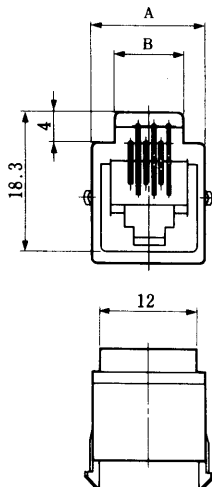
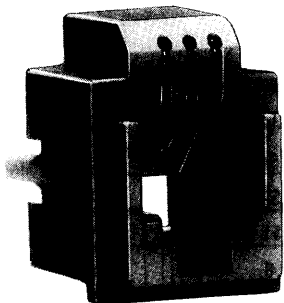

PCB mounting hole layout  
(Connector mounting side)

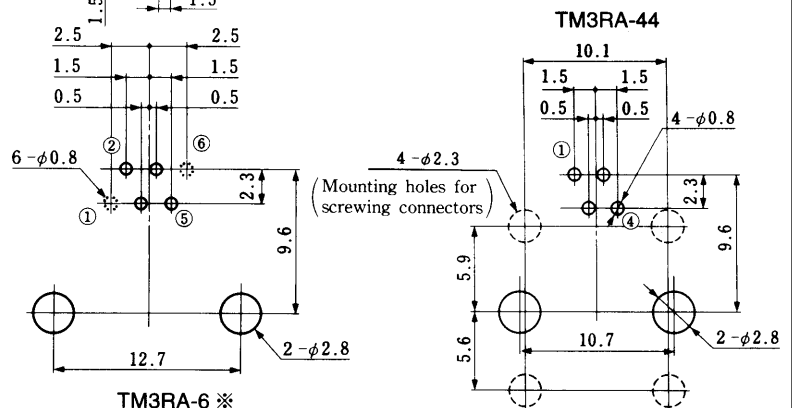

Note 1: Standard finish color is vanilla white.

Note 2: The drawing is shown sample of TM3RA-66.

# MODULAR CONNECTORS

CL 222 TM

● TM3RA-88  
CL222-1012-9

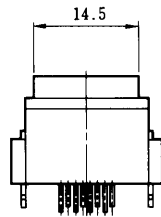
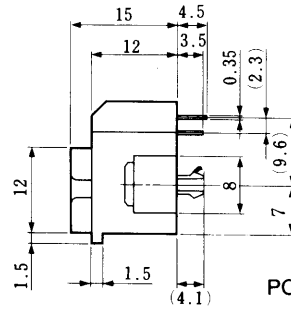
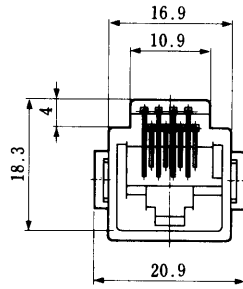
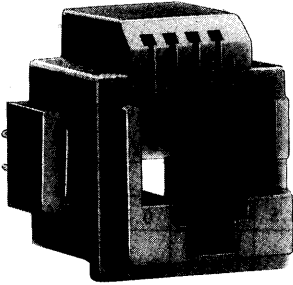

PCB mounting hole layout  
(Connector mounting side)

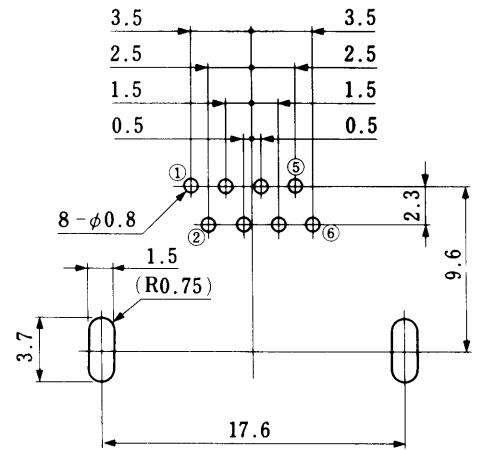

~~Note 1: (30) Stick packaging ... 27 units.~~  
Note 2: Standard finish color is vanilla white.

● TM3RA1- ※※

HRS No.	Part No.	A	B	C	D
CL222-1374-0-37	TM3RA1-44(37)	12.9	6.9	10.4	11
CL222-1375-2-37	TM3RA1-62(37)	14.9	8.9	12.4	13
CL222-1376-5-37	TM3RA1-64(37)	14.9	8.9	12.4	13
CL222-1377-8-37	TM3RA1-66(37)	14.9	8.9	12.4	13

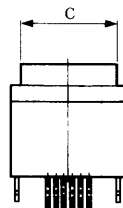
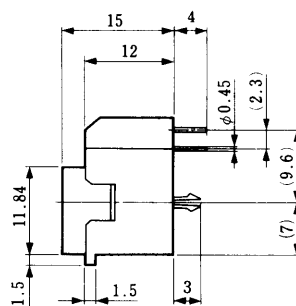
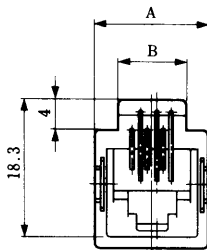
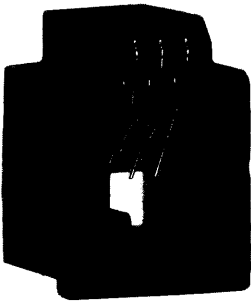

PCB mounting hole layout  
(Connector mounting side)

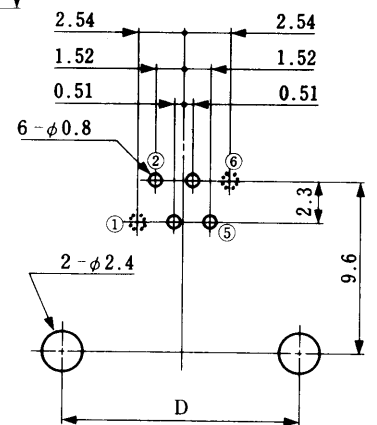

Note 1: (37) Stick packaging, type 44 ..... 42 units.  
type 6 ※ ... 36 units.  
Note 2: Standard finish color is black.  
Note 3: The drawing is shown sample of TM3RA1-66.

# MODULAR CONNECTORS

CL 222 TM

## Gang-Jacks Straight Dip Type

● TM2RE-06 ※※

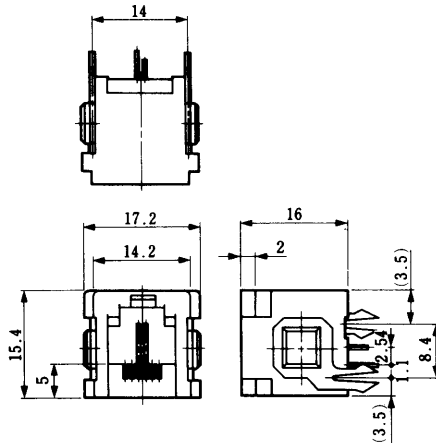
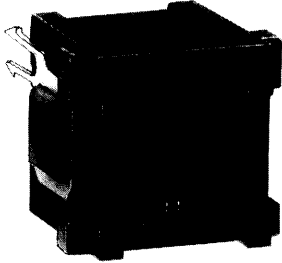

PCB mounting hole layout  
(Connector mounting side)

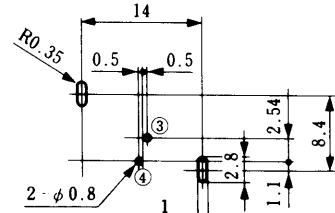

CL222-1286-4  
TM2RE-0602

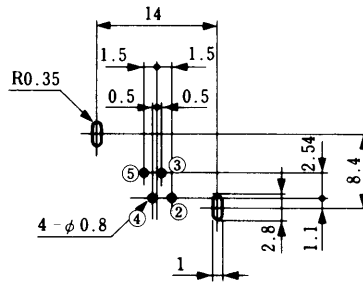

CL222-1391-9  
TM2RE-0604

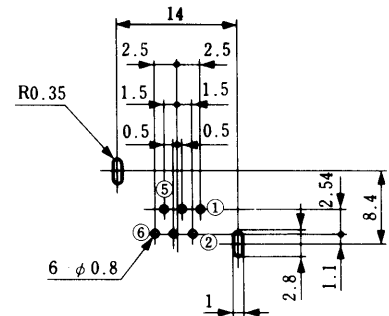

CL222-1422-0  
TM2RE-0606

Note 1 : Standard finish color is grey.

Note 2 : The drawing is shown sample of TM2RE-0602.

● TM2RE-12 ※※

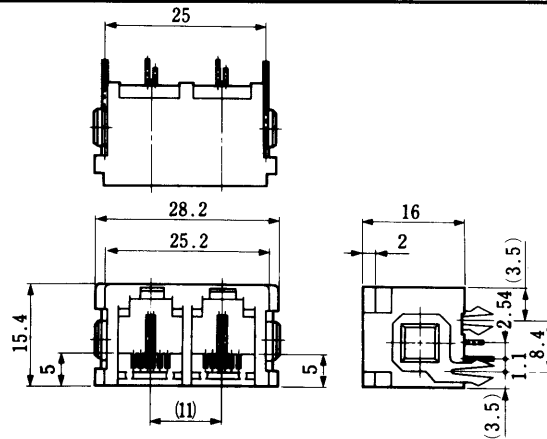
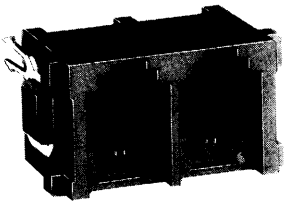

PCB mounting hole layout  
(Connector mounting side)

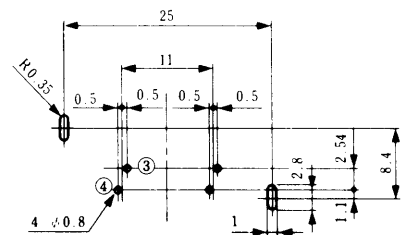

CL222-0592-5  
TM2RE-1204

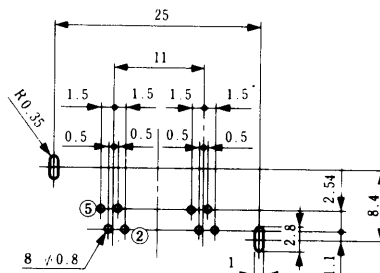

CL222-0756-0  
TM2RE-1208

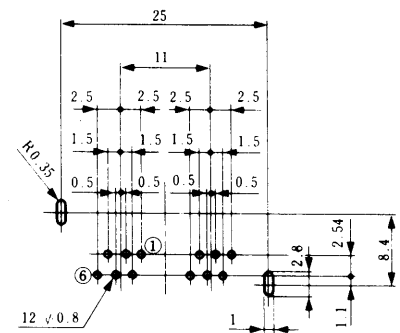

CL222-0757-3  
TM2RE-1212

Note 1 : Standard finish color is grey.

Note 2 : The drawing is shown sample of TM2RE-1204.

# MODULAR CONNECTORS

CL 222 TM

## ● TM2RE-18 ※※

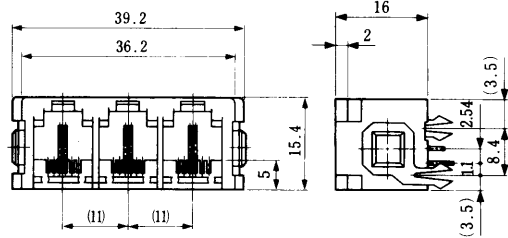
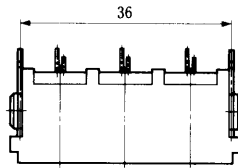
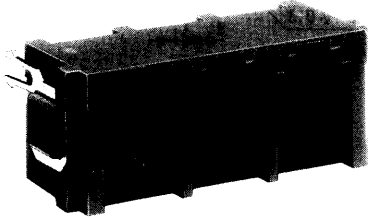

PCB mounting hole layout  
(Connector mounting side)

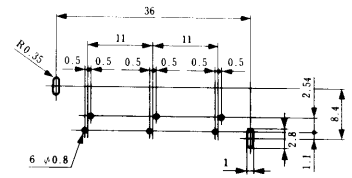

CL222-0591-2  
TM2RE-1806

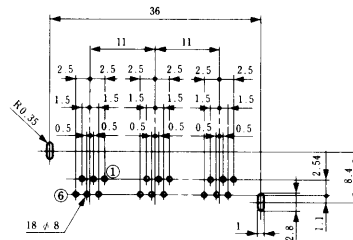

CL222-0796-5  
TM2RE-1818

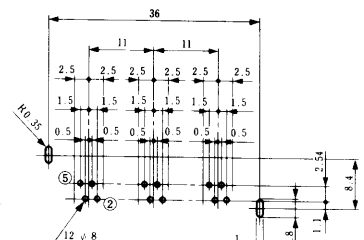

CL222-0753-2  
TM2RE-1812

Note 1: Standard finish color is grey.

Note 2: The drawing is shown sample of TM2RE-1806.

## ● TM2RE-24 ※※

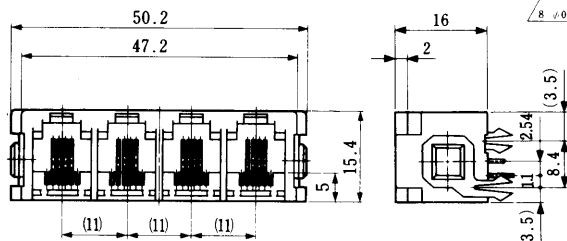
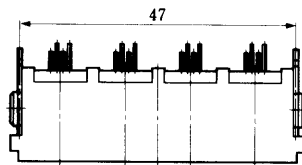
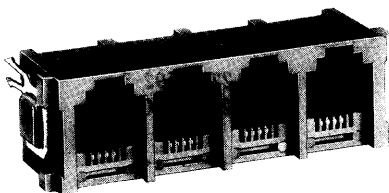

PCB mounting hole layout (Connector mounting side)

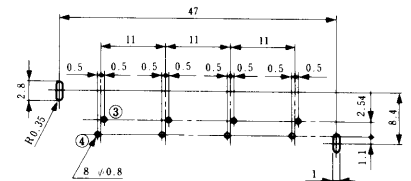

CL222-0797-8  
TM2RE-2408

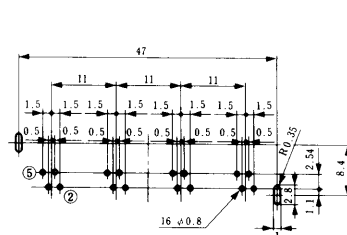

CL222-0590-0  
TM2RE-2416

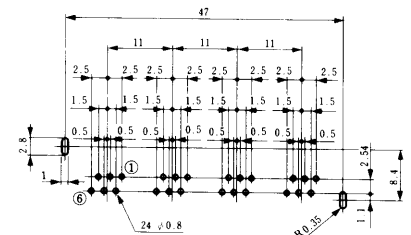

CL222-0751-7  
TM2RE-2424

Note 1: Standard finish color is grey.

Note 2: The drawing is shown sample of TM2RE-2416.

# MODULAR CONNECTORS

CL 222 TM

● TM3RA1-1010A  
CL222-2526-1

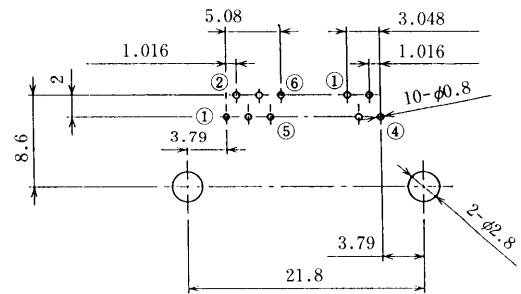
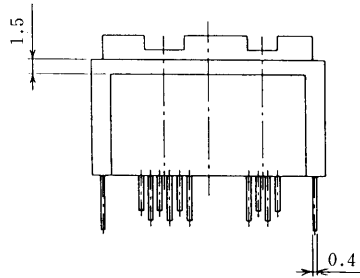
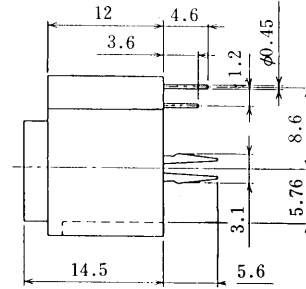
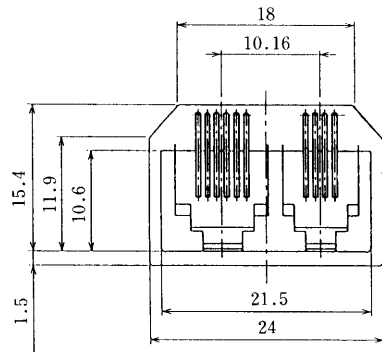
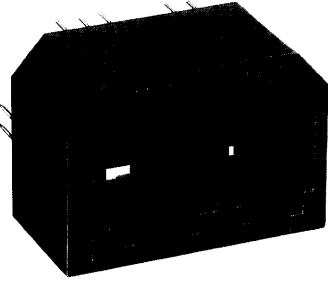

PCB mounting hole layout  
(Connector mounting side)

Note: Standard finish color is black.

● TM3RB1-1010  
CL222-2598-2

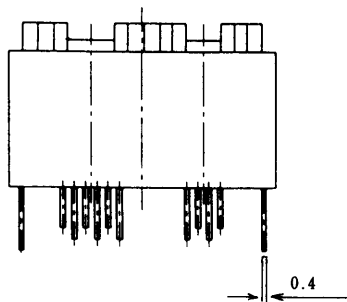
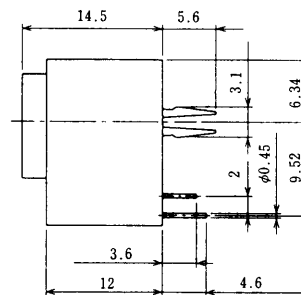
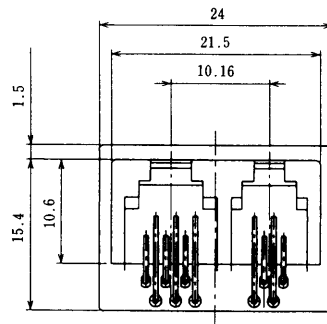
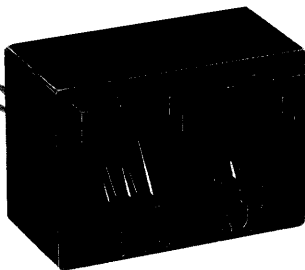

PCB mounting hole layout  
(Connector mounting side)

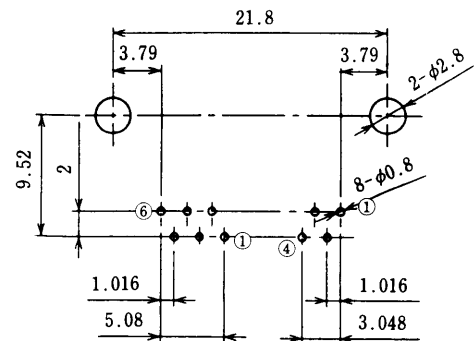

Note: Standard finish color is black.