

*Customer :

SPECIFICATION

ITEM	TOP LED DEVICE
MODEL	SSC-KWT821
PART NO.	REV00

[Contents]

1. Features -----	2
2. Absolute Maximum Ratings -----	2
3. Electro-optical Characteristics -----	2
4. CIE Chromaticity Diagram -----	3
5. Characteristic Diagram -----	4
6. Soldering Profile -----	5
7. Outline Dimensions And Materials -----	6
8. Reel Dimensions -----	7
9. Reel Packing Structure -----	8
10. Lot Number -----	9
11. Precaution for Use -----	10
12. Reliability -----	11

CUSTOMER

Checked by	Approved by

SUPPLIER

Drawn by	Checked by	Approved by



1.Features

- White colored SMT package
- High brightness by using 3-chips (White)
- Suitable for all SMT assembly methods ; Suitable for all soldering methods
- Applications :
 - Mobile Handset
 - Illumination
 - Backlighting

2. Absolute Maximum Ratings*¹

($T_a=25^{\circ}\text{C}$)

Parameter	Symbol	Value	Unit
Power Dissipation	P_d	360	mW
Forward Current	I_F	90	mA
Peak Forward Current	I_{FM}^{*2}	270	mA
LED Junction Temperature	T_j	125	$^{\circ}\text{C}$
Operating Temperature	T_{opr}	-30 ~ +85	$^{\circ}\text{C}$
Storage Temperature	T_{stg}	-40 ~ +100	$^{\circ}\text{C}$

*1 Care is to be taken that Power Dissipation does not exceed the Absolute Maximum Rating of the product.

*2 I_{FM} conditions is Pulse width $T_w \leq 300\text{ms}$, Duty ratio $\leq 1/10$.

3. Electro-Optical Characteristics

($T_a=25^{\circ}\text{C}$)

Parameter	Symbol	Condition	Min	Typ	Max	Unit
Forward Voltage (per die)	V_F	$I_F = 20 \text{ mA}$	2.9	3.2	3.6	V
Reverse Current (per die)	I_R	$V_R = 5\text{V}$	-	-	100	μA
Luminous Intensity * ¹	I_V	$I_F = 60 \text{ mA}$	-	4	-	cd
		$I_F = 90 \text{ mA}$		6		
Viewing Angle * ²	$2\theta_{1/2}$	$I_F = 60 \text{ mA}$	-	120	-	deg.
Color Temperature		$I_F = 60 \text{ mA}$	4800		12000	K
Chromaticity Coordinates	X	$I_F = 60 \text{ mA}$	-	0.31	-	-
	Y	$I_F = 60 \text{ mA}$	-	0.31	-	-

*1. The luminous intensity I_V is measured at the peak of the spatial pattern which may not be aligned with the mechanical axis of the LED package. Luminous Intensity Measurement allowance is $\pm 10\%$.

*2. $\theta_{1/2}$ is the off-axis where the luminous intensity is 1/2 of the peak intensity.

Note : All measurements were made under the standardized environment of SSC.

4. CIE Chromaticity Diagram

ICI Chromaticity Diagram

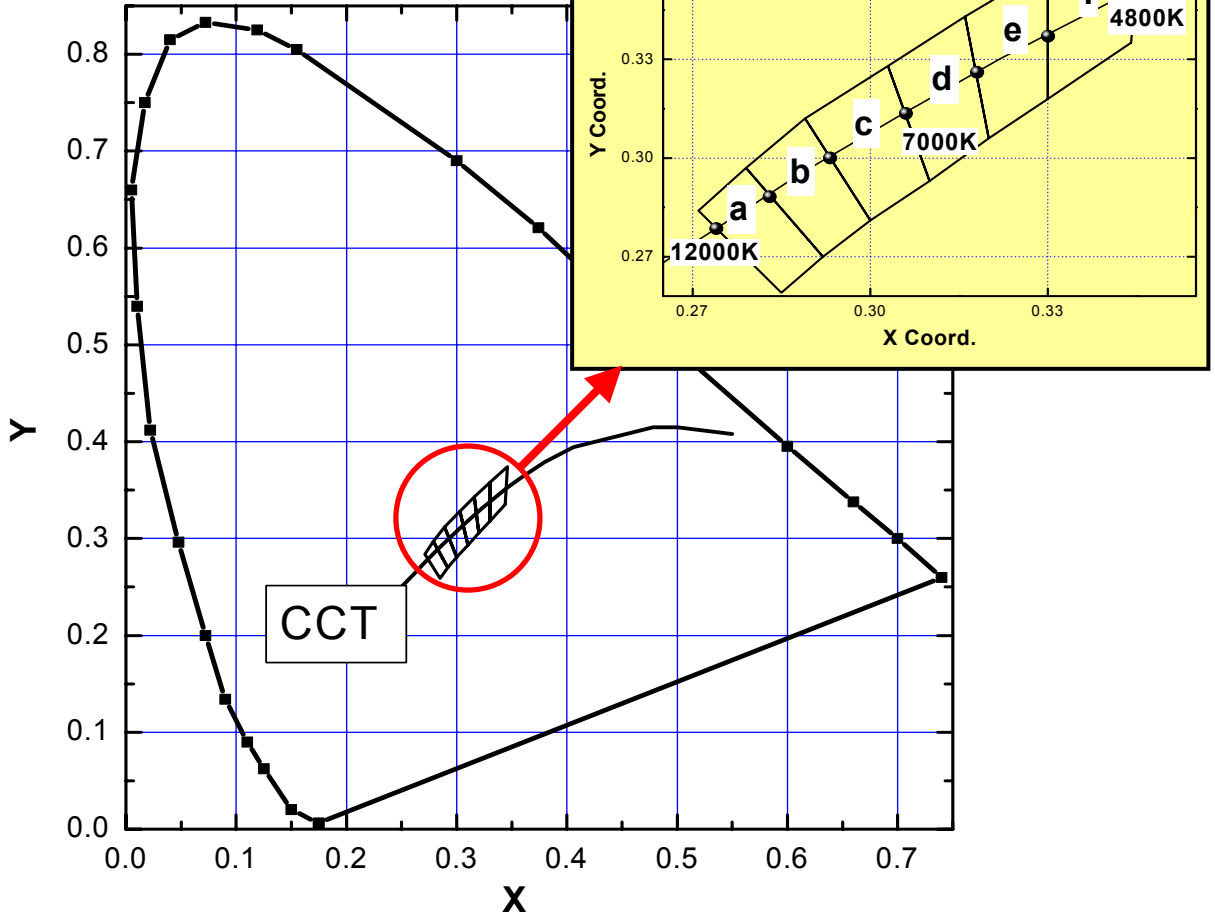

* Color Rank

($I_F=60\text{mA}$, $T_a=25$)

BIN	Chromaticity Coordinates				
	x	y	x	y	
a	x	0.279	0.292	0.285	0.271
	y	0.297	0.270	0.259	0.284
b	x	0.300	0.289	0.279	0.292
	y	0.281	0.312	0.297	0.270
c	x	0.310	0.303	0.289	0.300
	y	0.293	0.328	0.312	0.281
d	x	0.320	0.316	0.303	0.310
	y	0.306	0.343	0.328	0.293
e	x	0.320	0.316	0.330	0.330
	y	0.306	0.343	0.358	0.318
f	x	0.344	0.346	0.330	0.330
	y	0.335	0.374	0.358	0.318

● Measurement Uncertainty of the Color Coordinates : ± 0.01

5. Characteristic Diagram

⊙ Forward Voltage vs.
Forward Current (per die)

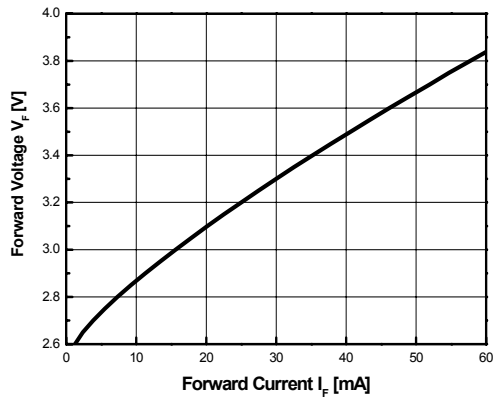

⊙ Forward Current vs.
Relative Intensity

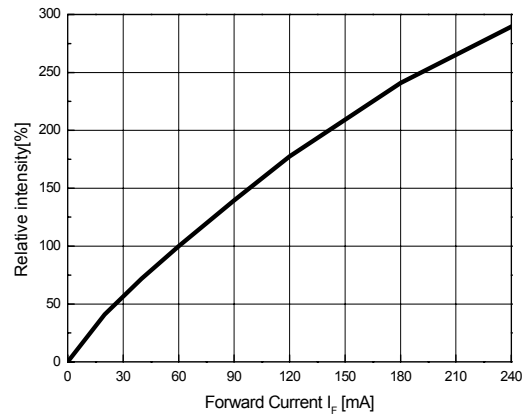

⊙ Ambient Temperature vs.
Allowable Forward Current(per die)

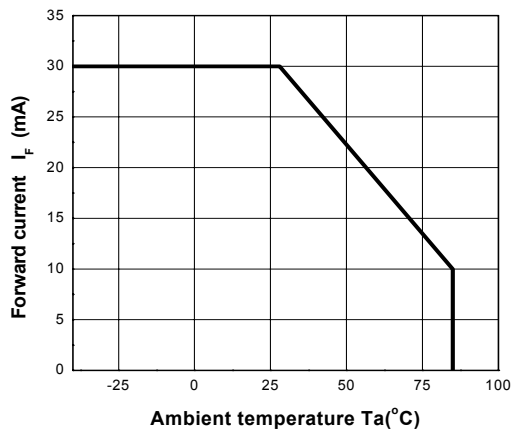

⊙ Radiation Diagram

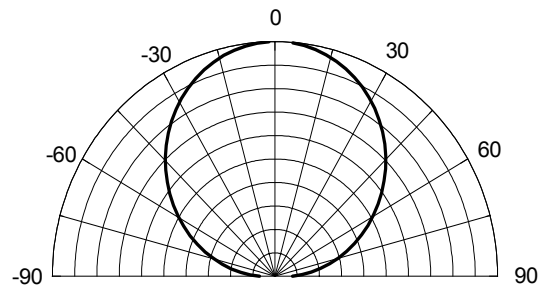

⊙ Spectrum

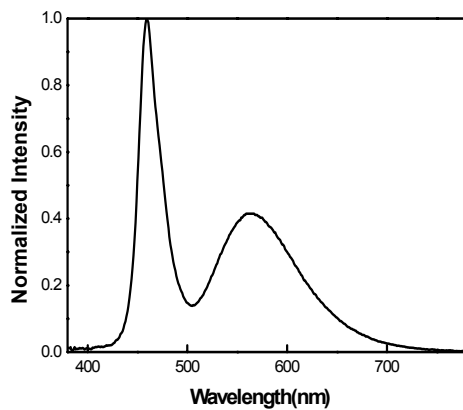

6. Soldering Profile

The LED can be soldered in place using the reflow soldering method.

(1) Lead solder

Preliminary heating to be at maximum 210°C for maximum 2 minutes.

Soldering heat to be at maximum 240°C for maximum 10 seconds.

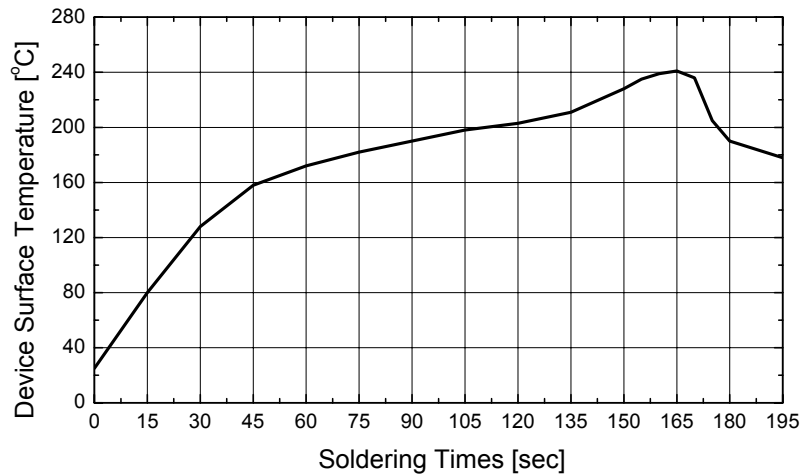

(2) Lead-free solder

Preliminary heating to be at maximum 220°C for maximum 2 minutes.

Soldering heat to be at maximum 260°C for maximum 10 seconds.

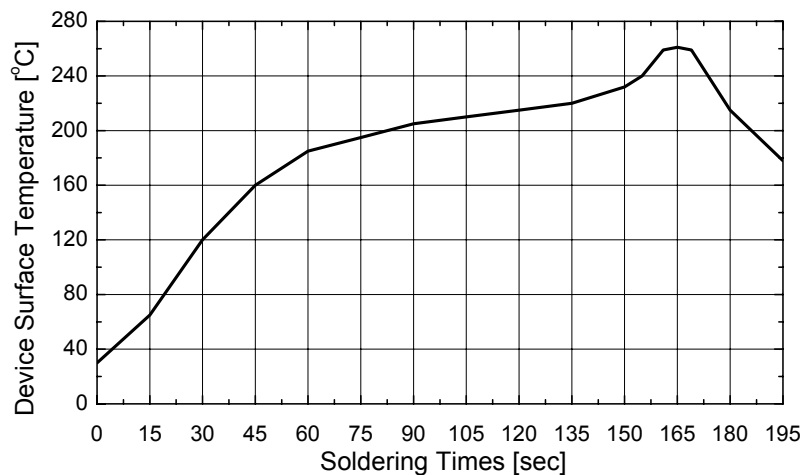

(3) Hand Soldering conditions

Not more than 5 seconds @MAX300°C, under Soldering iron.

Note : In case that the soldered products are reused in soldering process, we don't guarantee the products

7. Outline Dimensions And Materials

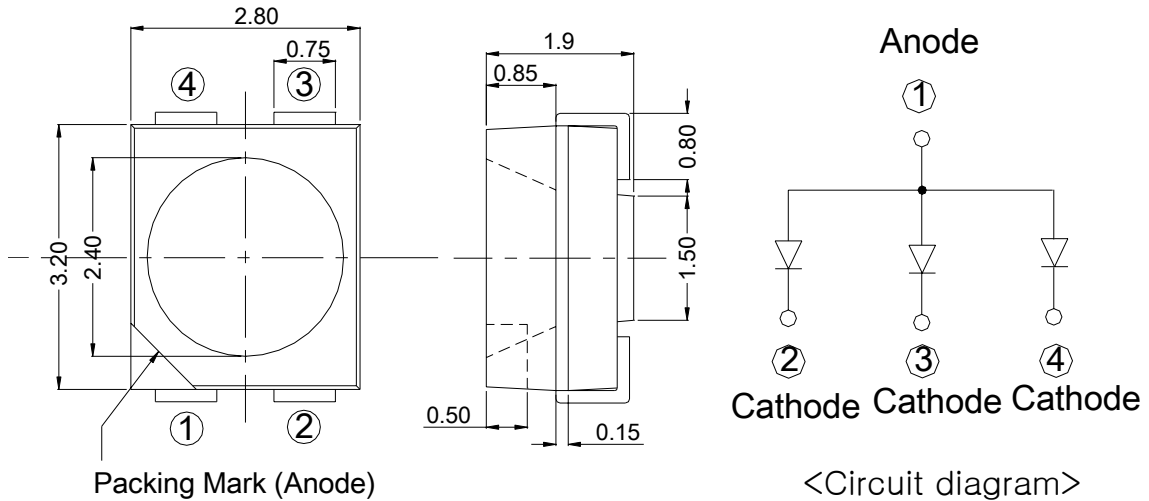

(Tolerance: ± 0.2 , Unit: mm)

Recommended Solder Pattern

*RECOMMENDED VIEW ANGLE FOR APPLICATION

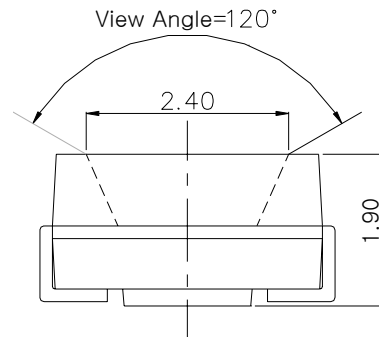
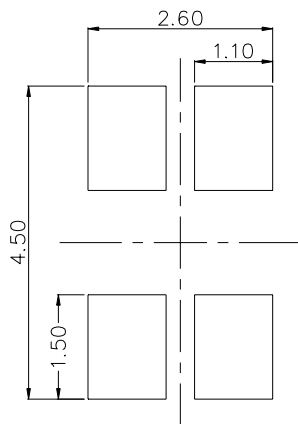

*MATERIALS

PARTS	MATERIALS
Package	Heat-Resistant Polymer
Encapsulation Resin	Mold Resin(with Phosphor)
Electrodes	Ag Plating Copper Alloy

8. Reel Dimensions

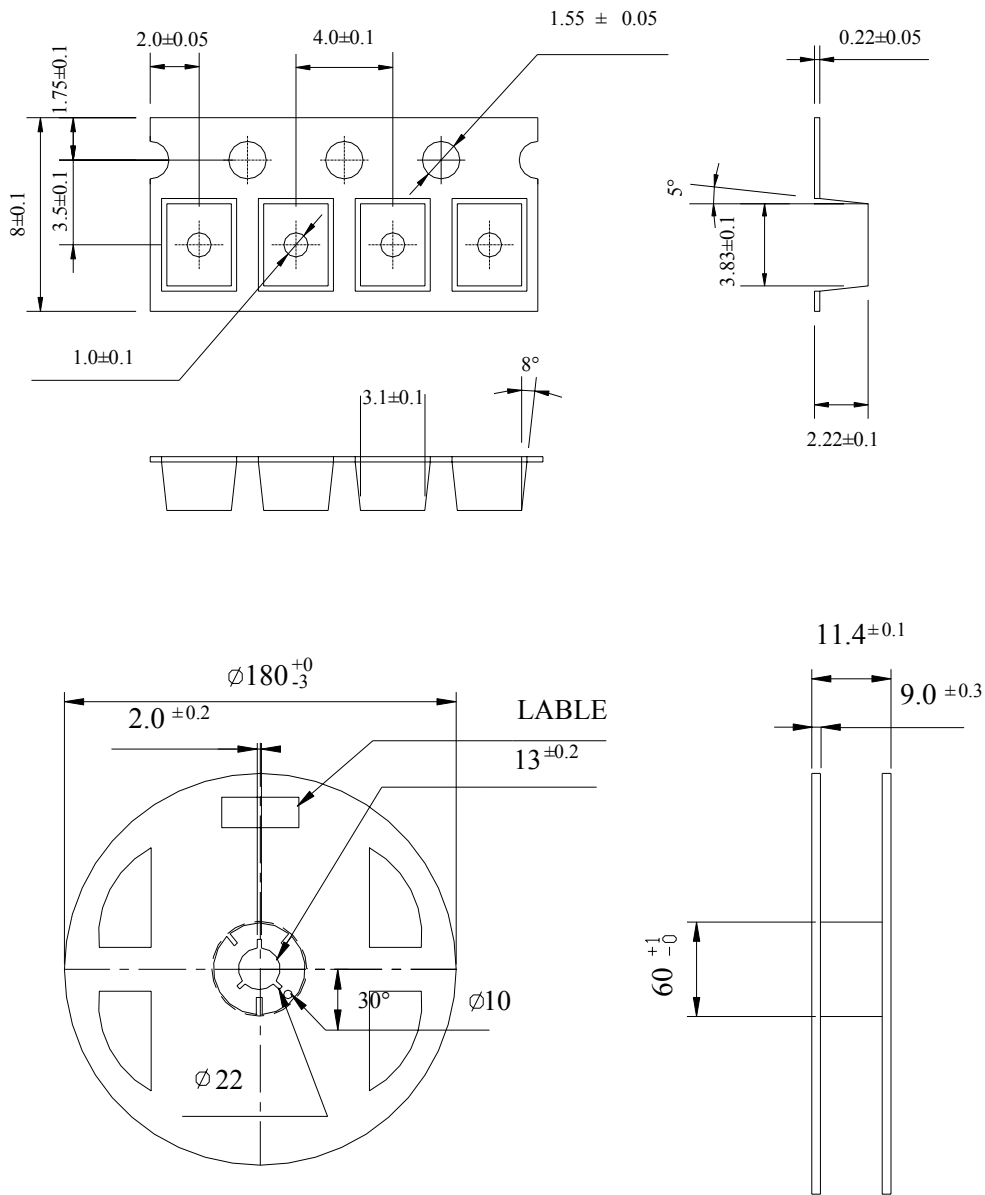

- (1) Quantity : 2000 pcs/Reel
- (2) Cumulative Tolerance: Cumulative Tolerance/10 pitches to be ± 0.2 mm
- (3) Adhesion Strength of Cover Tape : Adhesion strength to be 0.1 – 0.7N when the cover tape is turned off from the carrier at 10° angle to be the carrier tape.
- (4) Package:P/N, Manufacturing data Code No. and quantity to be indicated on a damp proof Package.

9. Reel Packing Structure

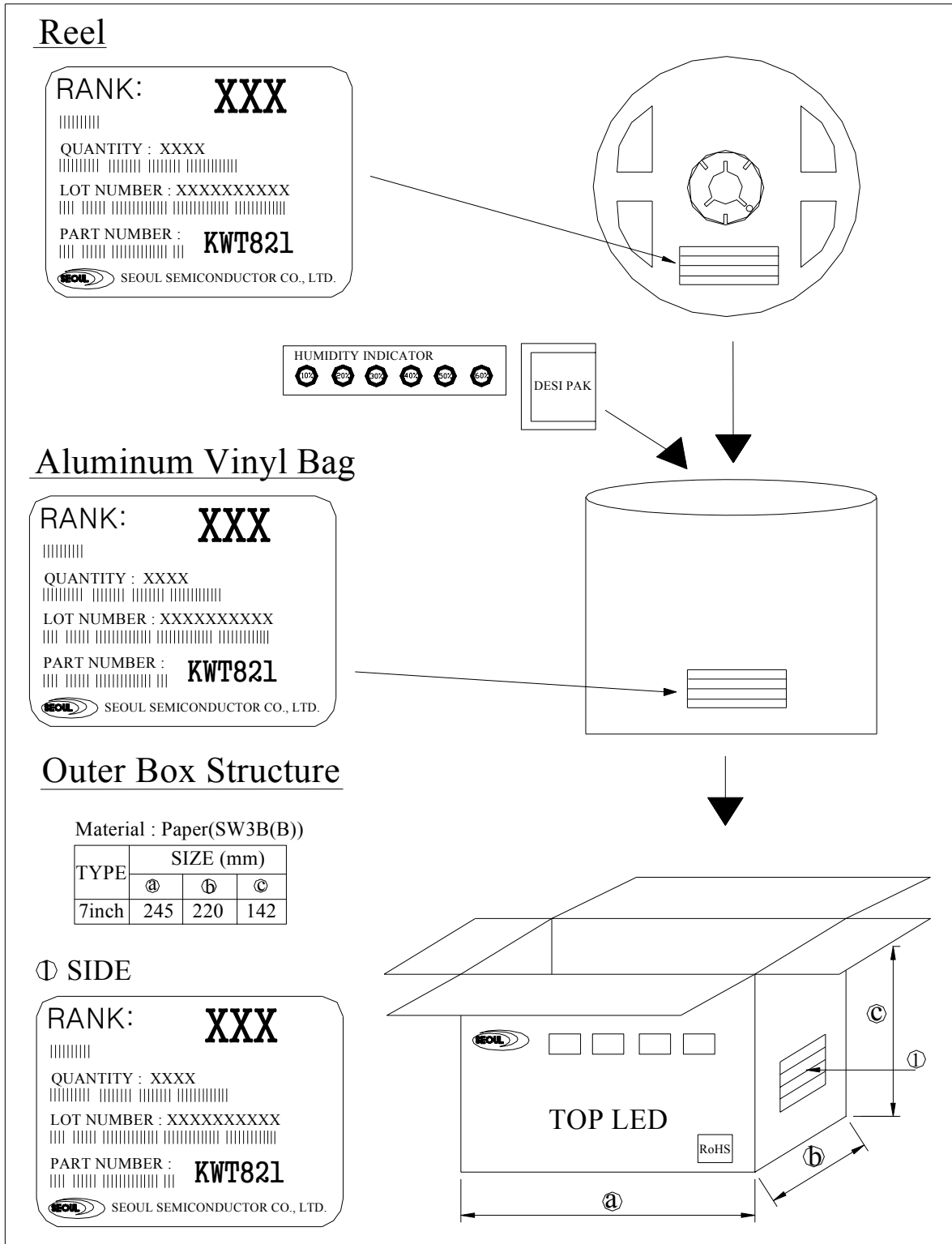

10. Lot Number

The lot number is composed of the following characters;

MWT□□□○○

○ – Year (1 for 2001, 2 for 2002, 3 for 2003)

□□ – Month (01 for Jan., 02 for Feb., ······11 for Nov., 12 for Dec.)

○○ – Day (01, 02, 03, 04, ··········28, 29, 30, 31.)

RANK:	XXx
QUANTITY :	XXXX
LOT NUMBER :	XXXXXXXXXX
PART NUMBER :	KWT821
	SEOUL SEMICONDUCTOR CO., LTD.

11. Precaution for use

(1) Storage

In order to avoid the absorption of moisture, it is recommended to store in a dry box (or a desiccator) with a desiccant. Otherwise, to store them in the following environment is recommended.

Temperature : 5 °C~30 °C Humidity : maximum 65%RH

(2) Attention after open.

LED is correspond to SMD, when LED be soldered dip, interfacial separation may affect the light transmission efficiency, causing the light intensity to drop. Attention in followed;

- a. After opened and mounted the soldering shall be quickly.
- b. Keeping of a fraction

Temperature : 5 ~ 40 °C Humidity : less than 30%

(3) In the case of more than 1 week passed after opening or change color of indicator on desiccant, components shall be dried 10-12hr. at 60±5 °C.

(4) Any mechanical force or any excess vibration shall not be accepted to apply during cooling process to normal temperature after soldering.

(5) Quick cooling shall be avoided.

(6) Components shall not be mounted on warped direction of PCB.

(7) Anti radioactive ray design is not considered for the products.

(8) This device should not be used in any type of fluid such as water, oil, organic solvent etc. When washing is required, IPA should be used.

(9) When the LEDs are illuminating, operating current should be decided after considering the ambient maximum temperature.

(10) LEDs must be stored to maintain a clean atmosphere. If the LEDs are stored for 3 months or more after being shipped from SSC, a sealed container with a nitrogen atmosphere should be used for storage.

(11) The LEDs must be soldered within seven days after opening the moisture-proof packing.

(12) Repack unused products with anti-moisture packing, fold to close any opening and then store in a dry place.

(13) The appearance and specifications of the product may be modified for improvement without notice.

12. RELIABILITY

(1) TEST ITEMS AND RESULTS

TEST ITEM	Test conditions	Test Point	Number of Damaged
Resistance to Soldering Heat* ¹	$T_{sld} = 260^{\circ}\text{C}$, 10 sec.	1 Time	0 /22
Solderability* ¹	$T_{sld} = 215 \pm 5^{\circ}\text{C}$, 5 sec.	1 Time	0 /22
Thermal Shock* ¹	-30 $^{\circ}\text{C}$ (30 min) ~ 85 $^{\circ}\text{C}$ (30 min) Transfer 5 min	100 cycles	0 /22
High Temperature Storage	$T_a = 100^{\circ}\text{C}$	1000 hrs.	0 /22
Humidity Heat Load	$T_a = 85^{\circ}\text{C}$, $RH = 85\%$	1000 hrs.	0 /22
Low Temperature Storage	$T_a = -40^{\circ}\text{C}$	1000 hrs.	0 /22
Steady State Life Test	$T_a = 25^{\circ}\text{C}$, $I_F = 60\text{ mA}$	1000 hrs.	0 /22
High Humidity Heat Life Test	$T_a = 85^{\circ}\text{C}$, $RH = 85\%$, $I_F = 45\text{ mA}$	1000 hrs.	0 /22
Low Temperature Life Test	$T_a = -30^{\circ}\text{C}$, $I_F = 60\text{ mA}$	1000 hrs.	0 /22

*¹ Faulty decision of this test item is made by On / Off after the test.

(2) CRITERIA FOR JUDGING THE DAMAGE

Item	Symbol	Test Condition	Criteria for Judgement	
			Min.	Max.
Forward Voltage	V_F	$I_F = 60\text{ mA}$	-	U.S.L \times 1.2
Reverse Current	I_R	$V_R = 5\text{ V/die}$	-	U.S.L \times 2.0
Luminous Intensity	I_V	$I_F = 60\text{ mA}$	L.S.L \times 0.7	-

U.S.L. : Upper Standard Level

L.S.L. : Lower Standard Level

(3)ESD guarantee condition

Item	Test Condition	Criteria for Judgement	Test Form
HBM	1000 V	$I_R = 100\ \mu\text{A}$ and below	CONTACT