

TO-258 Package Outline.
Dimensions in mm (inches)

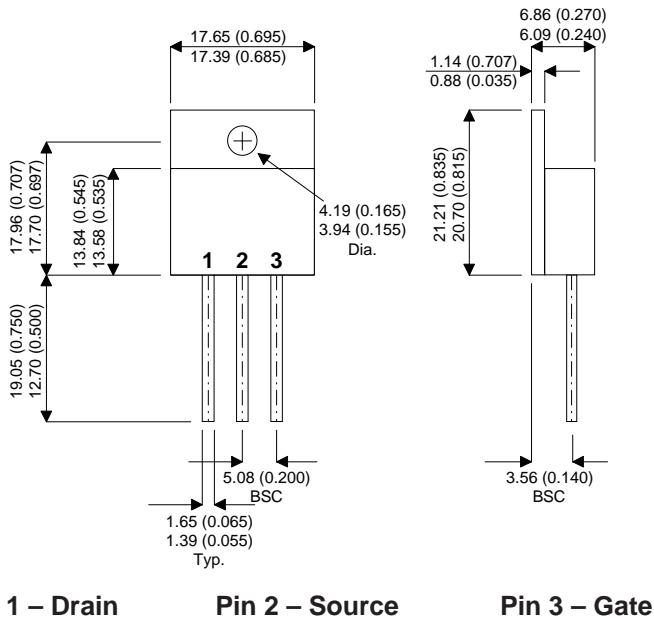

**N-CHANNEL
ENHANCEMENT MODE
HIGH VOLTAGE
POWER MOSFETS**

V_{DSS} 800V
 $I_{D(cont)}$ 11.5A
 $R_{DS(on)}$ 0.670Ω

- **Faster Switching**
- **Lower Leakage**
- **TO-258 Hermetic Package**

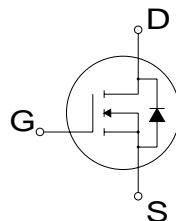

StarMOS is a new generation of high voltage N-Channel enhancement mode power MOSFETs. This new technology minimises the JFET effect, increases packing density and reduces the on-resistance. StarMOS also achieves faster switching speeds through optimised gate layout.

ABSOLUTE MAXIMUM RATINGS ($T_{case} = 25^{\circ}C$ unless otherwise stated)

V_{DSS}	Drain – Source Voltage	800	V
I_D	Continuous Drain Current	11.5	A
I_{DM}	Pulsed Drain Current ¹	46	A
V_{GS}	Gate – Source Voltage	±30	V
V_{GSM}	Gate – Source Voltage Transient	±40	
P_D	Total Power Dissipation @ $T_{case} = 25^{\circ}C$	200	W
	Derate Linearly	1.6	W/°C
T_J, T_{STG}	Operating and Storage Junction Temperature Range	-55 to 150	°C
T_L	Lead Temperature : 0.063" from Case for 10 Sec.	300	
I_{AR}	Avalanche Current ¹ (Repetitive and Non-Repetitive)	11.5	A
E_{AR}	Repetitive Avalanche Energy ¹	30	mJ
E_{AS}	Single Pulse Avalanche Energy ²	1210	

1) Repetitive Rating: Pulse Width limited by maximum junction temperature.

2) Starting $T_J = 25^{\circ}C$, $L = 18.3mH$, $R_G = 25\Omega$, Peak $I_L = 11.5A$

STATIC ELECTRICAL RATINGS ($T_{case} = 25^{\circ}C$ unless otherwise stated)

	Characteristic	Test Conditions	Min.	Typ.	Max.	Unit
BV_{DSS}	Drain – Source Breakdown Voltage	$V_{GS} = 0V, I_D = 250\mu A$	800			V
I_{DSS}	Zero Gate Voltage Drain Current ($V_{GS} = 0V$)	$V_{DS} = V_{DSS}$			25	μA
		$V_{DS} = 0.8V_{DSS}, T_C = 125^{\circ}C$			250	
I_{GSS}	Gate – Source Leakage Current	$V_{GS} = \pm 30V, V_{DS} = 0V$			± 100	nA
$V_{GS(TH)}$	Gate Threshold Voltage	$V_{DS} = V_{GS}, I_D = 1.0mA$	2		4	V
$I_{D(ON)}$	On State Drain Current ²	$V_{DS} > I_{D(ON)} \times R_{DS(ON)}$ Max $V_{GS} = 10V$	11.5			A
$R_{DS(ON)}$	Drain – Source On State Resistance ²	$V_{GS} = 10V, I_D = 0.5 I_D [Cont.]$			0.670	Ω

DYNAMIC CHARACTERISTICS

	Characteristic	Test Conditions	Min.	Typ.	Max.	Unit
C_{iss}	Input Capacitance	$V_{GS} = 0V$		3050	3700	pF
C_{oss}	Output Capacitance	$V_{DS} = 25V$		300	420	
C_{rss}	Reverse Transfer Capacitance	$f = 1MHz$		150	225	
Q_g	Total Gate Charge ³	$V_{GS} = 10V$		150	225	nC
Q_{gs}	Gate – Source Charge	$V_{DD} = 0.5 V_{DSS}$		17	25	
Q_{gd}	Gate – Drain (“Miller”) Charge	$I_D = I_D [Cont.] @ 25^{\circ}C$		70	105	
$t_{d(on)}$	Turn-on Delay Time	$V_{GS} = 15V$		12	24	ns
t_r	Rise Time	$V_{DD} = 0.5 V_{DSS}$		11	22	
$t_{d(off)}$	Turn-off Delay Time	$I_D = I_D [Cont.] @ 25^{\circ}C$		60	90	
t_f	Fall Time	$R_G = 1.6\Omega$		12	24	

SOURCE – DRAIN DIODE RATINGS AND CHARACTERISTICS

	Characteristic	Test Conditions	Min.	Typ.	Max.	Unit
I_S	Continuous Source Current	(Body Diode)			11.5	A
I_{SM}	Pulsed Source Current ¹	(Body Diode)			46	
V_{SD}	Diode Forward Voltage ²	$V_{GS} = 0V, I_S = -I_D [Cont.]$			1.3	V
t_{rr}	Reverse Recovery Time	$I_S = -I_D [Cont.], di_S / dt = 100A/\mu s$		650		ns
Q_{rr}	Reverse Recovery Charge	$I_S = -I_D [Cont.], di_S / dt = 100A/\mu s$		9		μC

THERMAL CHARACTERISTICS

	Characteristic	Min.	Typ.	Max.	Unit
$R_{\theta JC}$	Junction to Case			0.62	$^{\circ}C/W$
$R_{\theta JA}$	Junction to Ambient			40	

1) Repetitive Rating: Pulse Width limited by maximum junction temperature.

2) Pulse Test: Pulse Width < 380 μs , Duty Cycle < 2%

3) See MIL-STD-750 Method 3471



CAUTION — Electrostatic Sensitive Devices. Anti-Static Procedures Must Be Followed.