

25Amp Fast Recovery Full Wave Bridge Rectifier MY100X — MY400X

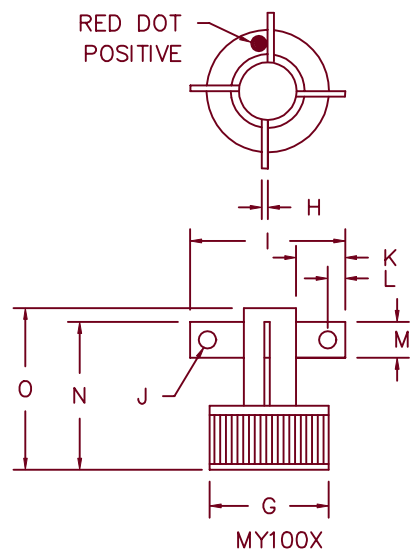

Note: Electrically Isolated

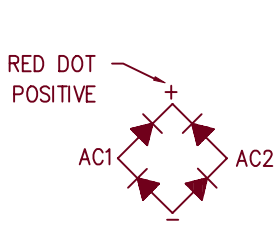
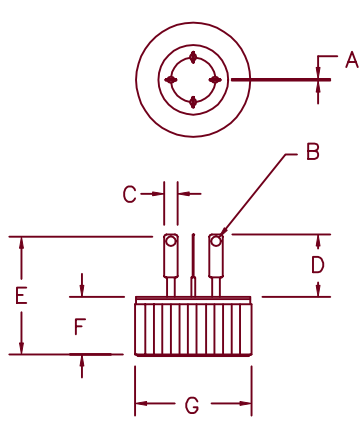
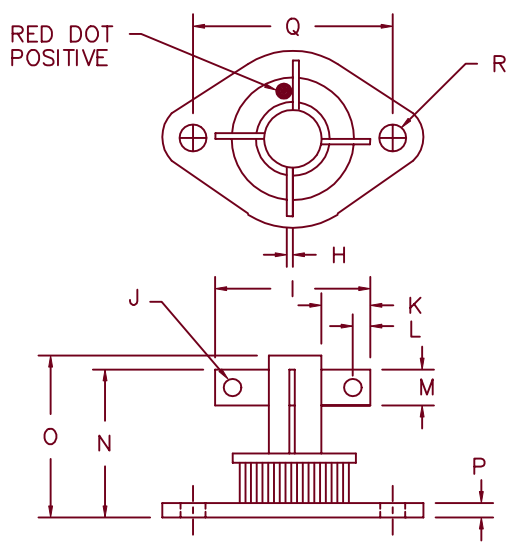

MY100XT

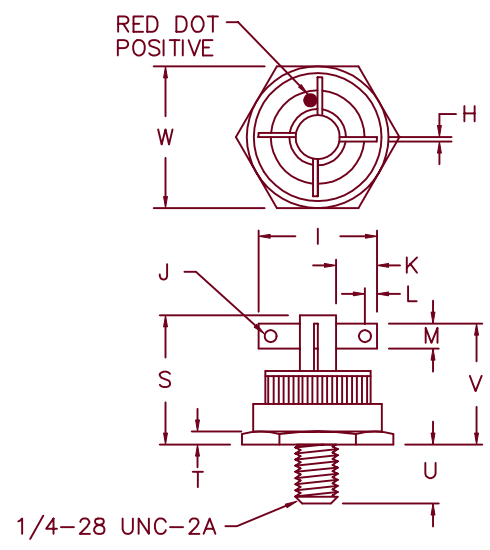

MY100XS

1/4-28 UNC-2A

Dim.	Inches		Millimeter		Notes
	Minimum	Maximum	Minimum	Maximum	
A	.018	.028	0.46	0.71	
B	---	.070 typ.	---	---	Dia.
C	---	.125 typ.	---	---	
D	.290	.330	7.37	8.38	
E	---	.825	---	20.95	
F	.390	.420	9.90	10.67	
G	.751	.755	19.07	19.18	
H	---	.032 typ.	---	---	
I	---	1.0	---	25.4	
J	---	.11 typ.	---	---	Dia.
K	.250	---	6.35	---	

Dim.	Inches		Millimeter		Notes
	Minimum	Maximum	Minimum	Maximum	
L	---	.125 Typ.	---	---	
M	---	.187 Typ.	---	---	
N	---	.830	---	21.08	
O	---	.930	---	23.62	
P	---	.135	---	3.43	
Q	1.177	1.197	29.90	30.40	
R	.151	.161	3.84	4.10	Dia.
S	---	1.20	---	30.48	
T	---	.125 typ.	---	---	
U	.340	.400	8.64	10.16	
V	---	1.10	---	27.94	
W	---	.875	---	22.83	

MY100X – MY400X

Microsemi
Catalog Number

MY100X
MY200X
MY300X
MY400X

Repetitive Peak
Reverse Voltage

100V
200V
300V
400V

- Glass Passivated Die
- Hermetically sealed
- Fast Recovery
- 175°C Junction temperature
- 2000VDC Isolation voltage

Electrical Characteristics

DC forward current output
Maximum Surge Current
Maximum I²t For Fusing
Max. Peak Forward Voltage per leg
Max. Peak Reverse Current
Max. Peak Reverse Current
Maximum Reverse Recovery Time

I_o 25A
I_{FSM} 150 Amps
I²t 93A²s
V_{FM} 1.3 Volts
I_{RM} 10 μA
I_{RM} 3 mA
t_{rr} 200 nS

T_C = 110°C
8.3ms, half sine, T_C = 110°C
I_{FM} = 25A, T_J = 25°C
V_{RM} = 200V, T_J = 25°C
V_{RM} = 200V, T_J = 150°C
I_F = 1A, I_R = 2A, I_{REC} = 0.5A

Thermal and Mechanical Characteristics

Storage temperature range
Operating junction temperature range
Max thermal resistance per package

T_{STG}
T_{OP}
R_{θJC}

-65°C to +175°C
-65°C to +175°C
1.0°C/W

MY100X — MY400X

Figure 1
Typical Forward Characteristics

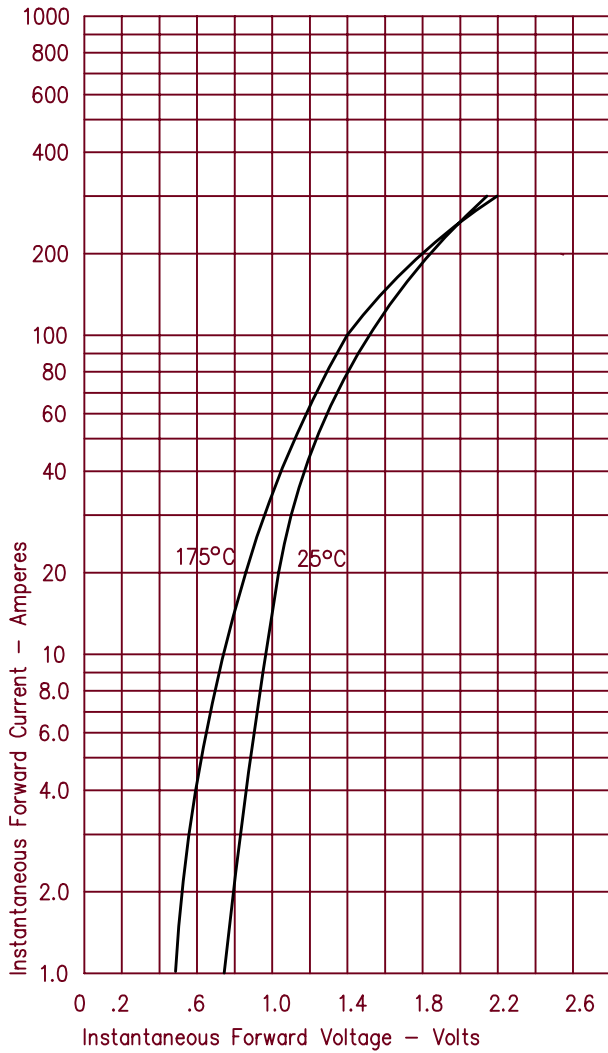

Figure 3
Forward Current Derating

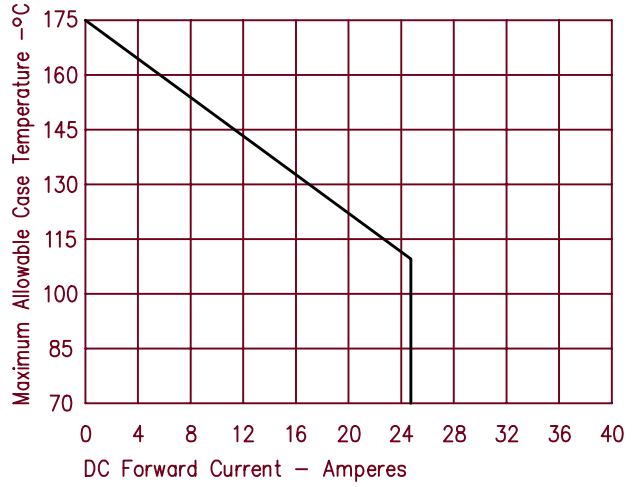

Figure 2
Typical Reverse Characteristics

