

### LC503AHR1-15P-A

#### Features

5mm Package  
 High Luminous Intensity  
 High Optical Power  
 All Plastic Mold Type  
 Water Clear Lens

#### Applications

Decorative Lighting  
 General Purpose Lighting  
 Indoor Message Centers  
 Instrumentation  
 Medical Equipment



### ATTENTION

OBSERVE PRECAUTIONS  
 ELECTROSTATIC  
 SENSITIVE DEVICES

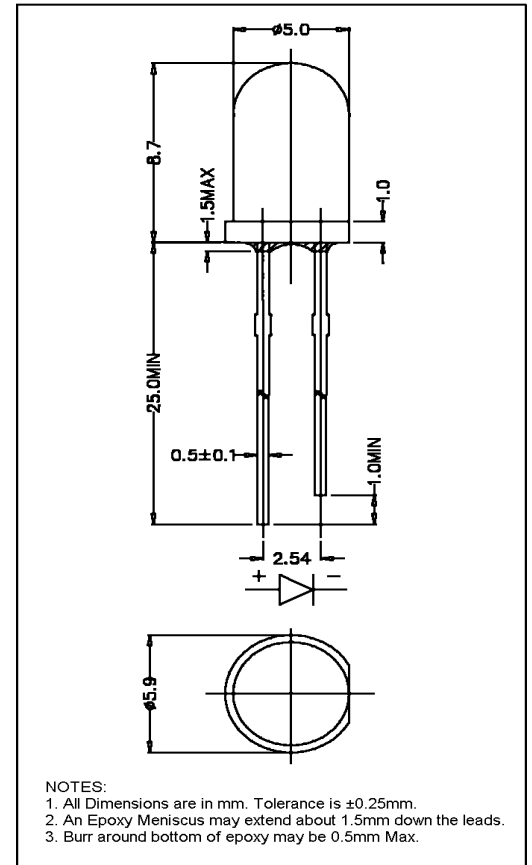

#### Maximum Ratings (Ta=25°C)

Characteristic	Symbol	Max.	Unit
Forward Current	I <sub>F</sub>	50	mA
Reverse Voltage	V <sub>R</sub>	5	V
Power Dissipation	P <sub>D</sub>	130.00	mW
Operating Temperature	T <sub>opr</sub>	-40 ~ +95	°C
Storage Temperature	T <sub>stg</sub>	-40 ~ +100	°C
Soldering Temperature	T <sub>sol</sub>	260	°C
Soldering Time	-	for 3 sec. max	-

#### Opto-Electrical Characteristics (Ta=25°C)

Characteristic	Symbol	Test Condition	Min	Typ	Max	Unit
Forward Voltage	V <sub>F</sub>	I <sub>F</sub> =20mA	-	2.10	2.60	V
Reverse Current	I <sub>R</sub>	V <sub>R</sub> =5V	-	-	100	μA
Luminous Intensity	I <sub>v</sub>	I <sub>F</sub> =20mA	5860.00	12000.00	-	mcd
Viewing Angle	2θ <sup>1/2</sup>	-	-	15°	-	deg.
Peak Wavelength	λ <sub>p</sub>	I <sub>F</sub> =20mA	-	632	-	nm
Dominant Wavelength	λ <sub>d</sub>	I <sub>F</sub> =20mA	-	624	-	nm
Spectral Line Half Width	Δλ	I <sub>F</sub> =20mA	-	20	-	nm

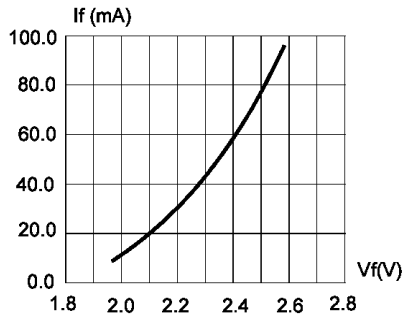

FIG.1 FORWARD CURRENT VS. FORWARD VOLTAGE.

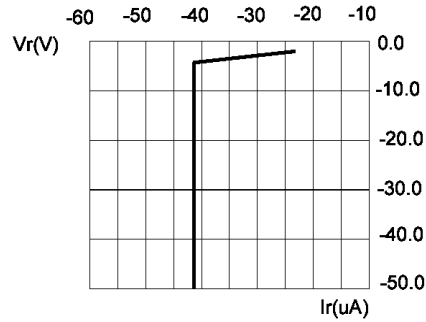

FIG.2 REVERSE CURRENT VS. REVERSE VOLTAGE.

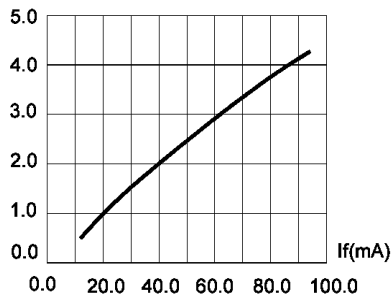

FIG.3 RELATIVE LUMINOUS INTENSITY VS. FORWARD CURRENT.

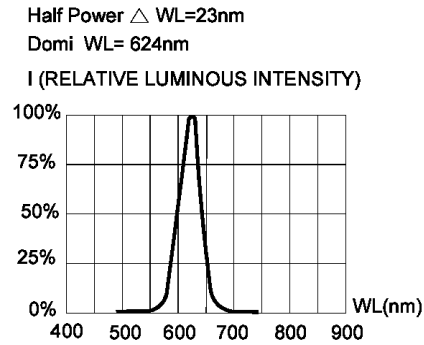

FIG.4 RELATIVE LUMINOUS INTENSITY VS. WAVELENGTH.

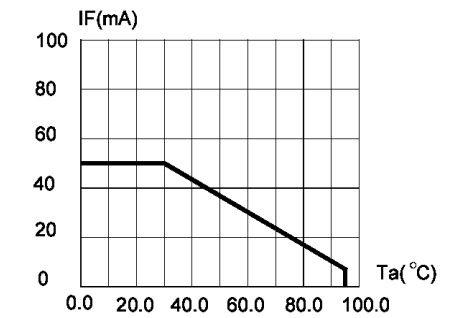

FIG.5 MAXIMUM FORWARD DC CURRENT VS AMBIENT TEMPERATURE ( $T_{jmax}=105^{\circ}C$ )

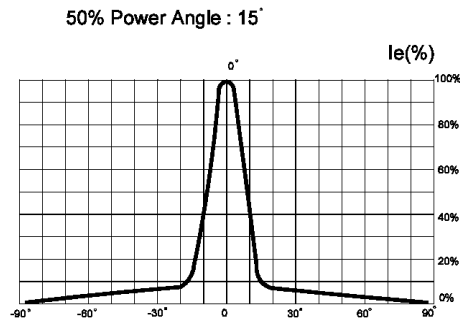

FIG.6 FAR FIELD PATTERN