

# Red LED/Photo IC for optical link

## L7140-10/S7141-10

For 50 Mbps optical link

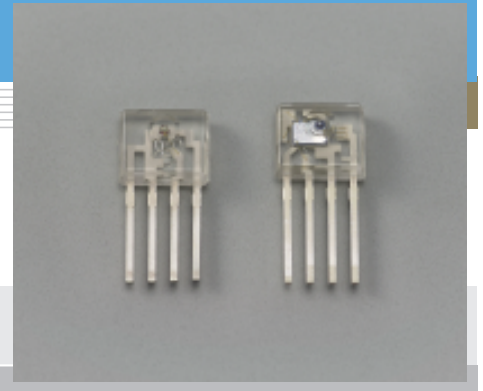

### Features

#### L7140-10

- Peak emission wavelength: 650 nm
- High output power
- High-speed response

#### S7141-10

- DC to 50 Mbps data transmission
- Miniature size due to monolithic IC structure
- Designed to be used with L7140-10
- Digital output
- Inversion logic

### Applications

- Data transmission in FA or OA applications subject to large amounts of electro magnetic noise
- High-speed, short distance data transmission
- Burst data transmission

#### ■ Absolute maximum ratings (Ta=25 °C)

Parameter	Symbol	Value	Unit	
L7140-10	Reverse voltage	VR	5	V
	Forward current	IF	40	mA
S7141-10	Power supply	Vcc	-0.5 to +7	V
	Output current	Ioh	10	mA
Power dissipation *1	P	250	mW	
Operating temperature	Topr	-10 to +70	°C	
Storage temperature	Tstg	-40 to +85	°C	
Soldering	-	230 °C, 5 s, at least 1.5 mm away from package surface		

\*1: Derate power dissipation at a rate of 1.75 mW/°C above Ta=25 °C

#### ■ Electrical and optical characteristics (L7140-10) (Ta=25 °C)

Parameter	Symbol	Condition	Min.	Typ.	Max.	Unit
Data rate	fd	Driven by recommended circuit	DC	-	50	Mbps
Forward voltage	VF	IF=20 mA	-	1.9	2.3	V
Reverse current	IR	VR=5 V	-	-	10	μA
Fiber coupled optical power	Po	IF=10 mA *2	-10	-	-	dBm
		IF=20 mA *2	-7	-	-	
Peak wavelength	λp	IF=20 mA	-	650	-	nm
Spectral half width (FWHM)	Δλ	IF=20 mA	-	20	-	nm
Rise time at pulse drive	tr	IF=20 mA, driven by recommended circuit *3	-	-	8	ns
Fall time at pulse drive	tf	IF=20 mA, driven by recommended circuit *3	-	-	8	ns

\*2: Output from a 1 meter long plastic fiber (GH4001 made by Mitsubishi Rayon) set close to the molded lens.

\*3: Output optical waveform is defined by the waveform shown below.

#### ■ Output optical waveform definition

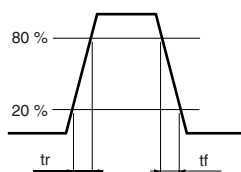

KLEDC0015EB

#### ■ L7140-10 output optical waveform example

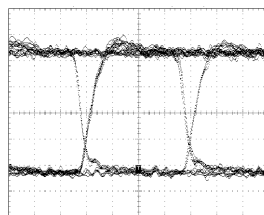

5 ns/div.

KLEDC0019EA

#### ■ Drive circuit example

(R1=300 Ω, R2=750 Ω, C1=77 pF)

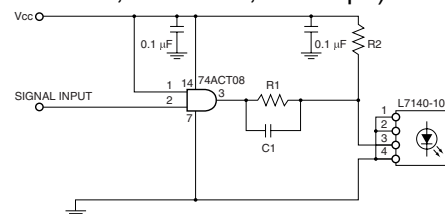

KLEDC0014EB

\* This is merely an example of drive circuit and not for actual large-volume production purposes.

**SOLID STATE DIVISION**

## ■ Electrical and optical characteristics (S7141-10) (Ta=25 °C)

Parameter	Symbol	Condition	Min.	Typ.	Max.	Unit
Data rate	f <sub>D</sub>		DC		50	Mbps
Supply voltage	V <sub>CC</sub>		4.75	-	5.25	V
Current consumption	I <sub>CC</sub>	Without light input	-	-	32	mA
Pulse width distortion	ΔT		-6	-	+6	ns
Minimum overload	P <sub>imax</sub>	*4 *5	-5	-	-	dBm
Minimum receiver input power	P <sub>imin</sub>	*4 *5	-	-	-17.5	dBm
Rise time	t <sub>r</sub>	*5	-	-	7	ns
Fall time	t <sub>f</sub>	*5	-	-	7	ns
Output voltage	V <sub>oh</sub>	I <sub>oh</sub> =20 μA	2	-	-	V
	V <sub>ol</sub>	I <sub>ol</sub> = -0.6 mA *6	-	-	1	V

\*4: Output from a 1 meter long plastic fiber (GH4001 made by Mitsubishi Rayon) set close to the molded lens.

\*5: Evaluated based on the input/output waveforms shown below. Measured with a low-capacitance FET probe (3 pF or less).

\*6: Output is the "L" level (inversion logic) when light is input.

### ■ Input optical waveform definition

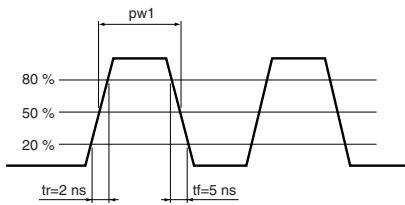

### ■ Output optical waveform definition

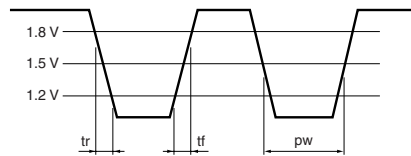

$$\Delta T = pw1 - pw$$

### ■ S7141-10 output waveform example

(Input light is referenced by drive circuit on front page)

(Ta=25 °C, Pi= -16 dBm, Vcc=5.0 V)

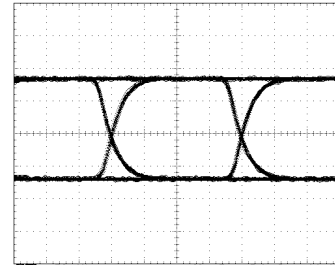

5 ns/div.

KPIC0068EA

### ■ Dimensional outline (unit: mm)

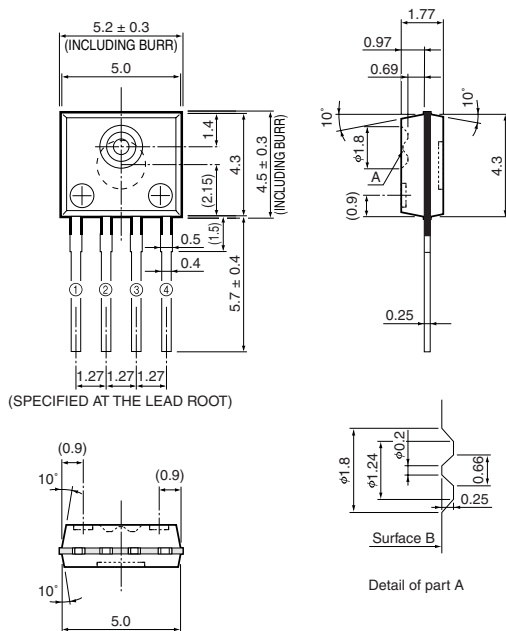

(SPECIFIED AT THE LEAD ROOT)

Lens tip does not project over surface B.

Tolerance unless otherwise noted: ±0.1, ±2°  
Shaded area indicates burr.  
Values in parentheses indicate reference value.

KPIC0043EC

PIN No.	L7140-10	S7141-10
①	CATHODE	GND
②	CATHODE	OUT
③	ANODE	GND
④	CATHODE	V <sub>CC</sub>

■ An evaluation kit M7647 consisting of L7140-10, S7141-10 and POF is also available.

