

IRGP30B60KD-E

INSULATED GATE BIPOLAR TRANSISTOR WITH ULTRAFAST SOFT RECOVERY DIODE

Features

- Low $V_{CE(on)}$ Non Punch Through IGBT Technology.
- Low Diode V_F .
- 10 μ s Short Circuit Capability.
- Square RBSOA.
- Ultrasoft Diode Reverse Recovery Characteristics.
- Positive $V_{CE(on)}$ Temperature Coefficient.
- TO-247AD Package

Benefits

- Benchmark Efficiency for Motor Control.
- Rugged Transient Performance.
- Low EMI.
- Excellent Current Sharing in Parallel Operation.

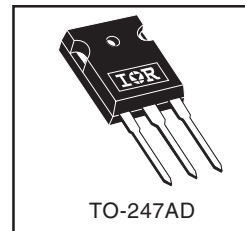
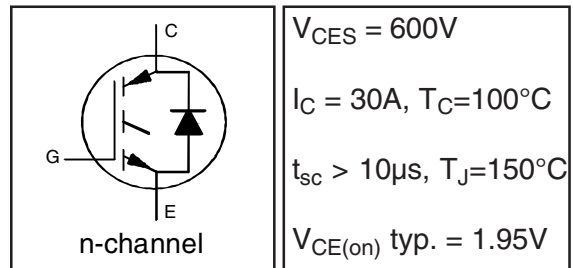

Absolute Maximum Ratings

	Parameter	Max.	Units
V_{CES}	Collector-to-Emitter Voltage	600	V
$I_C @ T_C = 25^\circ C$	Continuous Collector Current	60	A
$I_C @ T_C = 100^\circ C$	Continuous Collector Current	30	
I_{CM}	Pulsed Collector Current	120	
I_{LM}	Clamped Inductive Load Current ①	120	
$I_F @ T_C = 25^\circ C$	Diode Continuous Forward Current	60	
$I_F @ T_C = 100^\circ C$	Diode Continuous Forward Current	30	
I_{FM}	Diode Maximum Forward Current	120	
V_{GE}	Gate-to-Emitter Voltage	± 20	V
$P_D @ T_C = 25^\circ C$	Maximum Power Dissipation	304	W
$P_D @ T_C = 100^\circ C$	Maximum Power Dissipation	122	
T_J	Operating Junction and	-55 to +150	°C
T_{STG}	Storage Temperature Range		
	Soldering Temperature, for 10 sec.		
	Mounting Torque, 6-32 or M3 Screw	10 lbf•in (1.1N•m)	

Thermal Resistance

	Parameter	Min.	Typ.	Max.	Units
$R_{\theta JC}$	Junction-to-Case - IGBT	—	—	0.41	°C/W
$R_{\theta JC}$	Junction-to-Case - Diode	—	—	1.32	
$R_{\theta CS}$	Case-to-Sink, flat, greased surface	—	0.24	—	
$R_{\theta JA}$	Junction-to-Ambient, typical socket mount	—	—	40	
Wt	Weight	—	6.0	—	

IRGP30B60KD-E

International
IR Rectifier

Electrical Characteristics @ $T_J = 25^\circ\text{C}$ (unless otherwise specified)

	Parameter	Min.	Typ.	Max.	Units	Conditions	Ref.Fig.
$V_{(BR)CES}$	Collector-to-Emitter Breakdown Voltage	600	—	—	V	$V_{GE} = 0V, I_C = 500\mu A$	
$\Delta V_{(BR)CES}/\Delta T_J$	Temperature Coeff. of Breakdown Voltage	—	0.4	—	$V/^\circ\text{C}$	$V_{GE} = 0V, I_C = 1.0mA, (25^\circ\text{C}-150^\circ\text{C})$	
$V_{CE(on)}$	Collector-to-Emitter Saturation Voltage	—	1.95	2.35	V	$I_C = 30A, V_{GE} = 15V$	5,6,7
		—	2.40	2.75		$I_C = 30A, V_{GE} = 15V, T_J = 150^\circ\text{C}$	9,10,11
$V_{GE(th)}$	Gate Threshold Voltage	3.5	4.5	5.5	V	$V_{CE} = V_{GE}, I_C = 250\mu A$	9,10,11
$\Delta V_{GE(th)}/\Delta T_J$	Temperature Coeff. of Threshold Voltage	—	-10	—	$mV/^\circ\text{C}$	$V_{CE} = V_{GE}, I_C = 1.0mA, (25^\circ\text{C}-150^\circ\text{C})$	12
g_{fe}	Forward Transconductance	—	18	—	S	$V_{CE} = 50V, I_C = 50A, PW=80\mu s$	
I_{CES}	Zero Gate Voltage Collector Current	—	5.0	250	μA	$V_{GE} = 0V, V_{CE} = 600V$	
		—	1000	2000		$V_{GE} = 0V, V_{CE} = 600V, T_J = 150^\circ\text{C}$	
V_{FM}	Diode Forward Voltage Drop	—	1.30	1.55	V	$I_F = 30A$	8
		—	1.25	1.50		$I_F = 30A, T_J = 150^\circ\text{C}$	
I_{GES}	Gate-to-Emitter Leakage Current	—	—	± 100	nA	$V_{GE} = \pm 20V$	

Switching Characteristics @ $T_J = 25^\circ\text{C}$ (unless otherwise specified)

	Parameter	Min.	Typ.	Max.	Units	Conditions	Ref.Fig.
Q_g	Total Gate Charge (turn-on)	—	102	153	nC	$I_C = 30A$	23
Q_{ge}	Gate - Emitter Charge (turn-on)	—	14	21		$V_{CC} = 400V$	CT.1
Q_{gc}	Gate - Collector Charge (turn-on)	—	44	66		$V_{GE} = 15V$	
E_{on}	Turn-On Switching Loss	—	350	620	μJ	$I_C = 30A, V_{CC} = 400V$	CT.4
E_{off}	Turn-Off Switching Loss	—	825	955		$V_{GE} = 15V, R_G = 10\Omega, L = 200\mu H,$	
E_{tot}	Total Switching Loss	—	1175	1575		$L_S = 150nH, T_J = 25^\circ\text{C} \textcircled{2}$	
$t_{d(on)}$	Turn-On Delay Time	—	46	60	ns	$I_C = 30A, V_{CC} = 400V$	CT.4
t_r	Rise Time	—	28	39		$V_{GE} = 15V, R_G = 10\Omega, L = 200\mu H$	
$t_{d(off)}$	Turn-Off Delay Time	—	185	200		$L_S = 150nH, T_J = 25^\circ\text{C}$	
t_f	Fall Time	—	31	40			
E_{on}	Turn-On Switching Loss	—	635	1085	μJ	$I_C = 30A, V_{CC} = 400V$	CT.4
E_{off}	Turn-Off Switching Loss	—	1150	1350		$V_{GE} = 15V, R_G = 10\Omega, L = 200\mu H$	
E_{tot}	Total Switching Loss	—	1785	2435		$L_S = 150nH, T_J = 150^\circ\text{C} \textcircled{2}$	
$t_{d(on)}$	Turn-On Delay Time	—	46	60	ns	$I_C = 30A, V_{CC} = 400V$	CT.4
t_r	Rise Time	—	28	39		$V_{GE} = 15V, R_G = 10\Omega, L = 200\mu H$	
$t_{d(off)}$	Turn-Off Delay Time	—	205	235		$L_S = 150nH, T_J = 150^\circ\text{C}$	
t_f	Fall Time	—	32	42			
C_{ies}	Input Capacitance	—	1750	—	pF	$V_{GE} = 0V$	22
C_{oes}	Output Capacitance	—	160	—		$V_{CC} = 30V$	
C_{res}	Reverse Transfer Capacitance	—	60	—		$f = 1.0MHz$	
RBSOA	Reverse Bias Safe Operating Area	FULL SQUARE				$T_J = 150^\circ\text{C}, I_C = 120A, V_p = 600V$ $V_{CC} = 500V, V_{GE} = +15V \text{ to } 0V, R_G = 10\Omega$	4 CT.2
SCSOA	Short Circuit Safe Operating Area	10	—	—	μs	$T_J = 150^\circ\text{C}, V_p = 600V, R_G = 10\Omega$ $V_{CC} = 360V, V_{GE} = +15V \text{ to } 0V$	CT.3 WF.4
E_{rec}	Reverse Recovery energy of the diode	—	925	1165	μJ	$T_J = 150^\circ\text{C}$	17,18,19
t_{rr}	Diode Reverse Recovery time	—	125	—	ns	$V_{CC} = 400V, I_F = 30A, L = 200\mu H$	20,21
I_{rr}	Diode Peak Reverse Recovery Current	—	43	48	A	$V_{GE} = 15V, R_G = 10\Omega, L_S = 150nH$	CT.4, WF.3

Notes: ① $V_{CC} = 80\% (V_{CES}), V_{GE} = 15V, L = 28\mu H, R_G = 22\Omega.$ ② Energy losses include "tail" and diode reverse recovery.

IRGP30B60KD-E

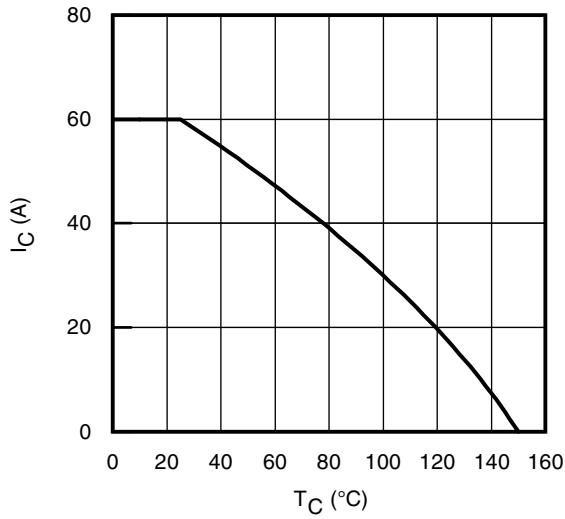

Fig. 1 - Maximum DC Collector Current vs. Case Temperature

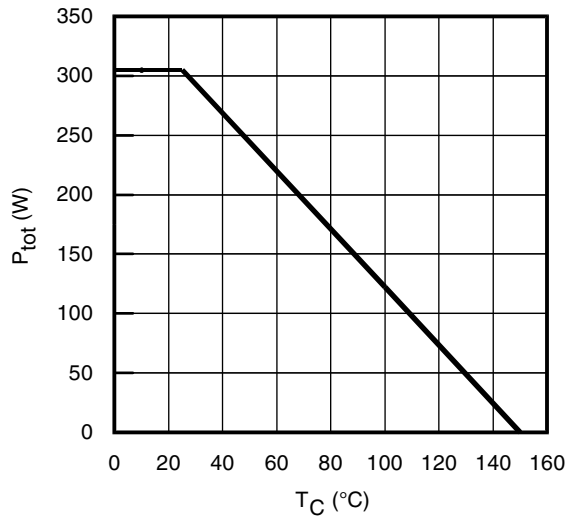

Fig. 2 - Power Dissipation vs. Case Temperature

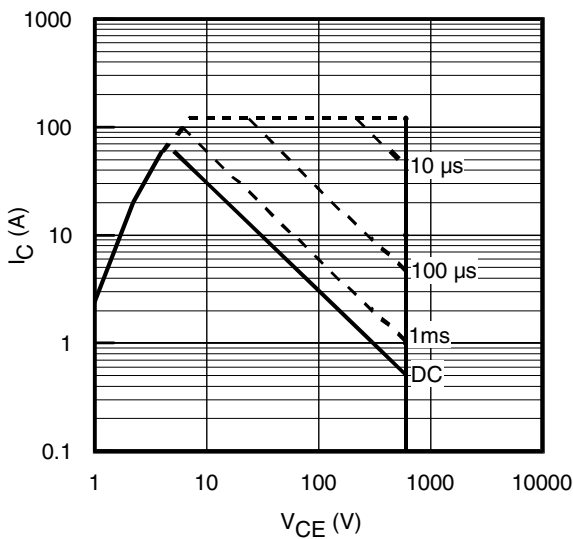

Fig. 3 - Forward SOA
 $T_C = 25^\circ\text{C}$; $T_J \leq 150^\circ\text{C}$

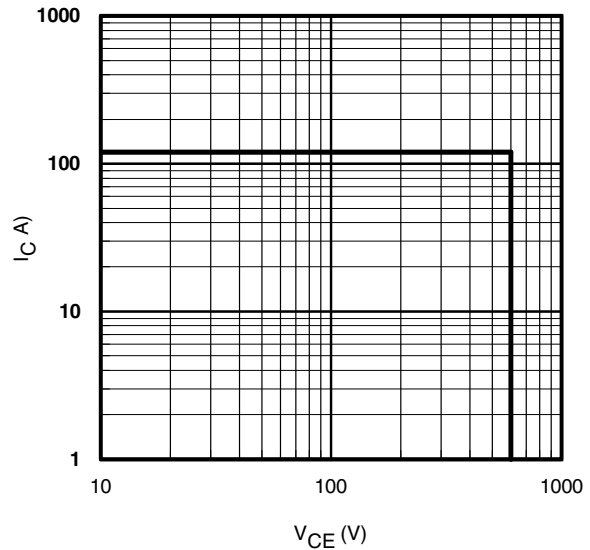

Fig. 4 - Reverse Bias SOA
 $T_J = 150^\circ\text{C}$; $V_{GE} = 15\text{V}$

IRGP30B60KD-E

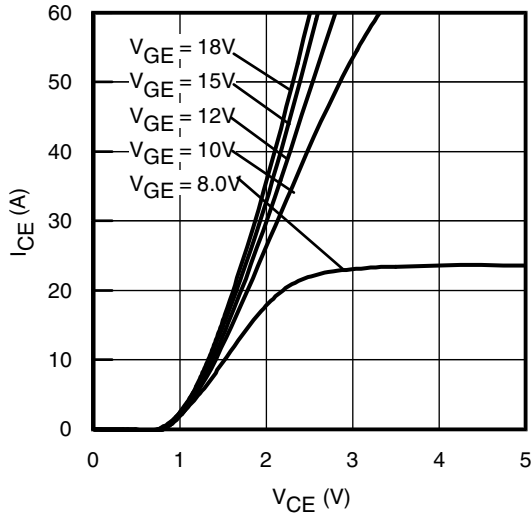

Fig. 5 - Typ. IGBT Output Characteristics
 $T_J = -40^\circ\text{C}$; $t_p = 80\mu\text{s}$

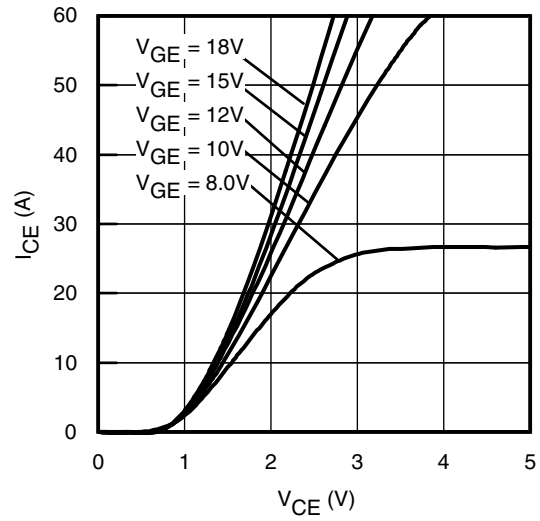

Fig. 6 - Typ. IGBT Output Characteristics
 $T_J = 25^\circ\text{C}$; $t_p = 80\mu\text{s}$

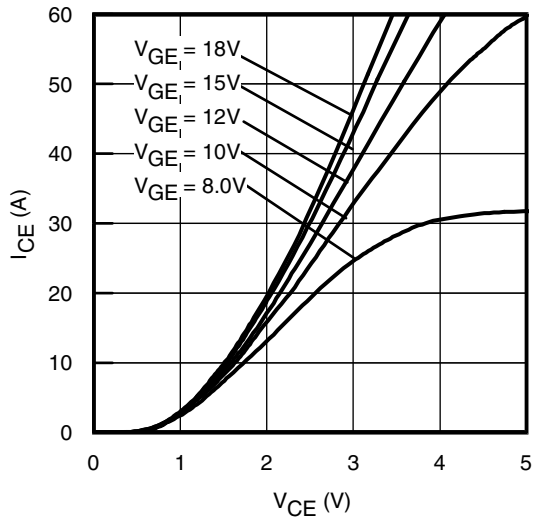

Fig. 7 - Typ. IGBT Output Characteristics
 $T_J = 150^\circ\text{C}$; $t_p = 80\mu\text{s}$

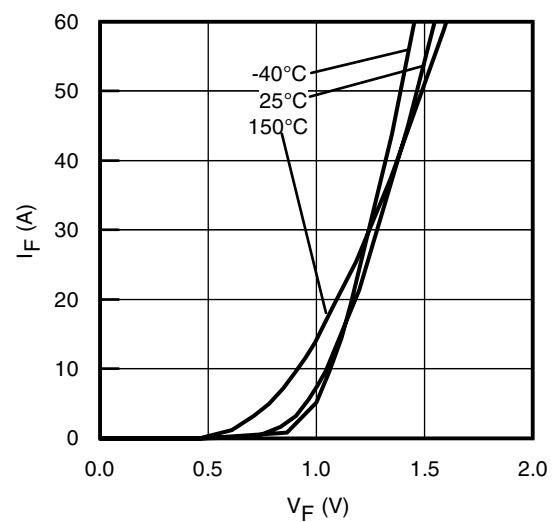

Fig. 8 - Typ. Diode Forward Characteristics
 $t_p = 80\mu\text{s}$

IRGP30B60KD-E

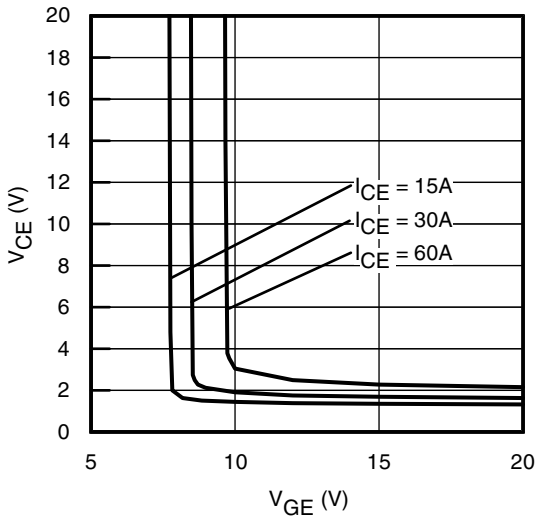

Fig. 9 - Typical V_{CE} vs. V_{GE}
 $T_J = -40^\circ\text{C}$

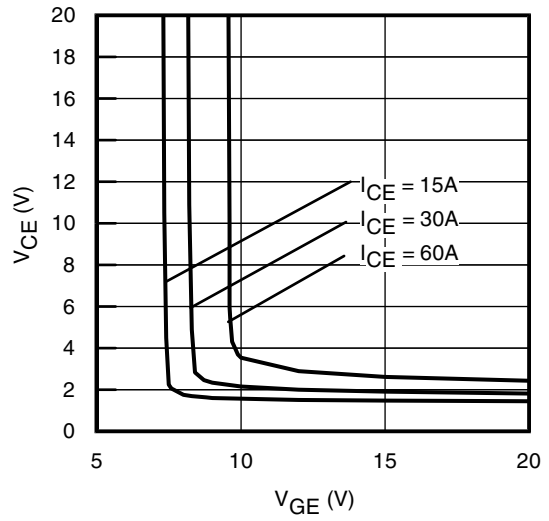

Fig. 10 - Typical V_{CE} vs. V_{GE}
 $T_J = 25^\circ\text{C}$

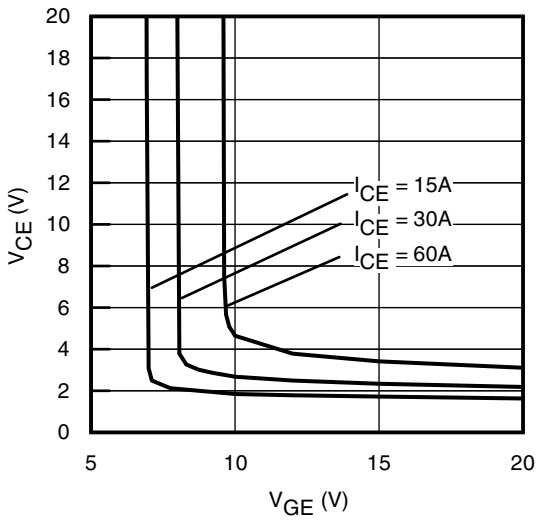

Fig. 11 - Typical V_{CE} vs. V_{GE}
 $T_J = 150^\circ\text{C}$

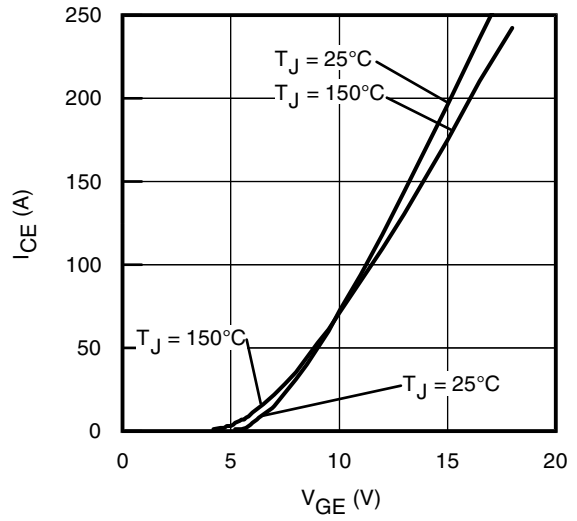

Fig. 12 - Typ. Transfer Characteristics
 $V_{CE} = 50\text{V}$; $t_p = 10\mu\text{s}$

IRGP30B60KD-E

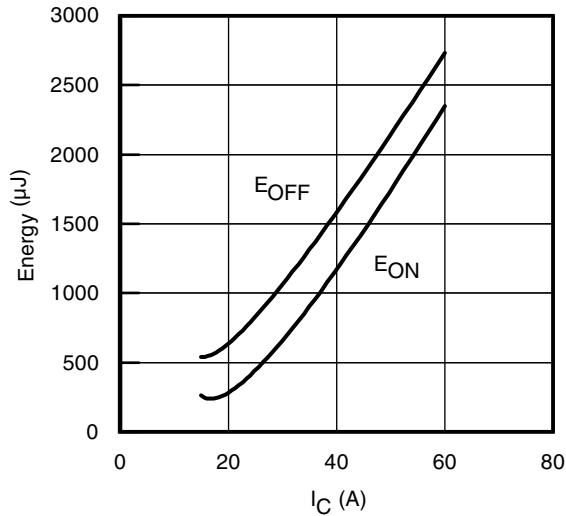

Fig. 13 - Typ. Energy Loss vs. I_C
 $T_J = 150^\circ\text{C}$; $L = 200\mu\text{H}$; $V_{CE} = 400\text{V}$
 $R_G = 10\Omega$; $V_{GE} = 15\text{V}$

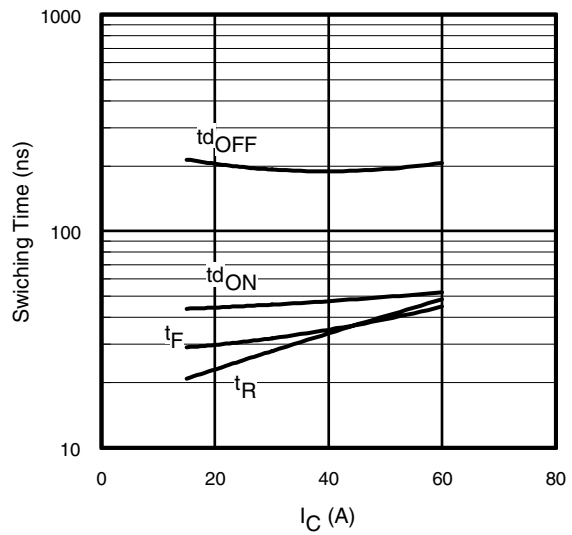

Fig. 14 - Typ. Switching Time vs. I_C
 $T_J = 150^\circ\text{C}$; $L = 200\mu\text{H}$; $V_{CE} = 400\text{V}$
 $R_G = 10\Omega$; $V_{GE} = 15\text{V}$

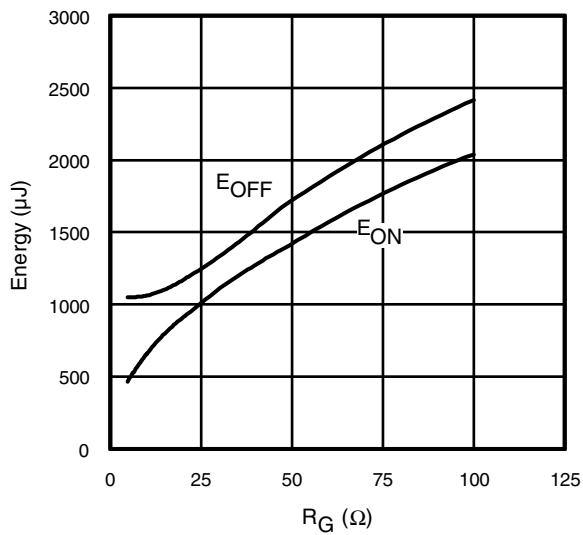

Fig. 15 - Typ. Energy Loss vs. R_G
 $T_J = 150^\circ\text{C}$; $L = 200\mu\text{H}$; $V_{CE} = 400\text{V}$
 $I_{CE} = 30\text{A}$; $V_{GE} = 15\text{V}$

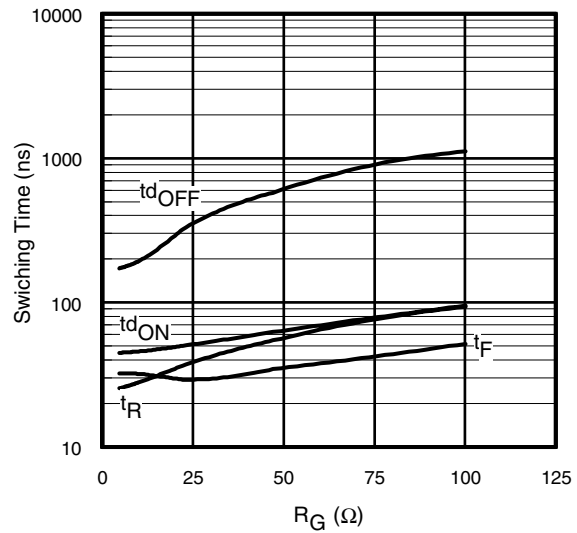

Fig. 16 - Typ. Switching Time vs. R_G
 $T_J = 150^\circ\text{C}$; $L = 200\mu\text{H}$; $V_{CE} = 400\text{V}$
 $I_{CE} = 30\text{A}$; $V_{GE} = 15\text{V}$

IRGP30B60KD-E

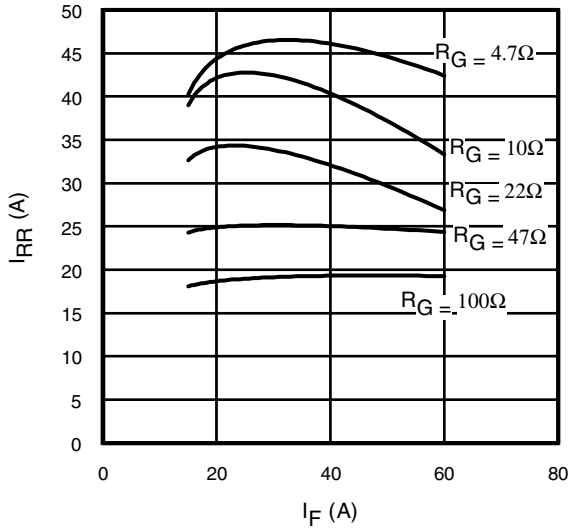

Fig. 17 - Typical Diode I_{RR} vs. I_F
 $T_J = 150^\circ\text{C}$

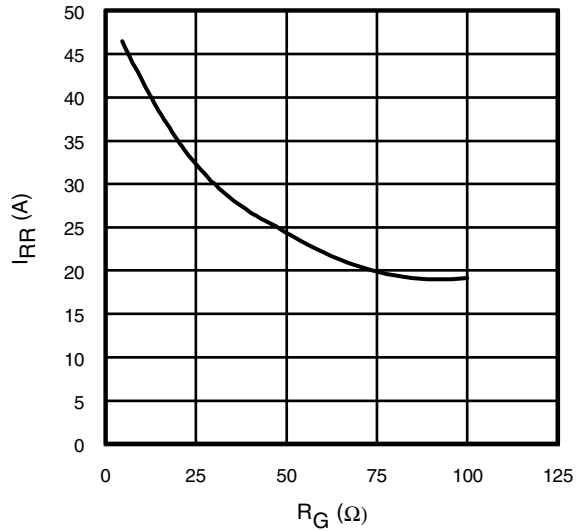

Fig. 18 - Typical Diode I_{RR} vs. R_G
 $T_J = 150^\circ\text{C}$; $I_F = 30\text{A}$

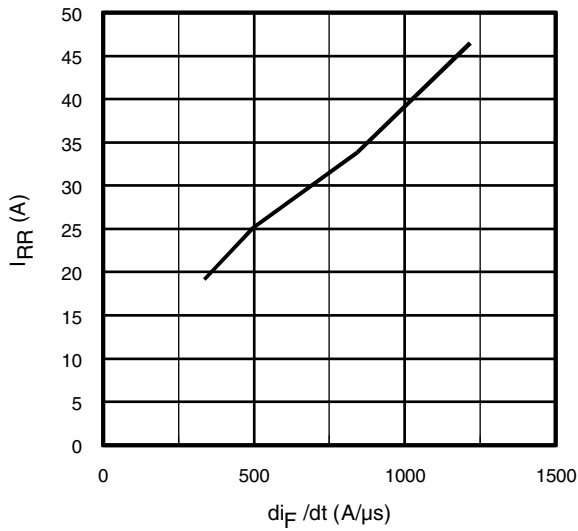

Fig. 19- Typical Diode I_{RR} vs. di_F/dt
 $V_{CC} = 400\text{V}$; $V_{GE} = 15\text{V}$;
 $I_F = 30\text{A}$; $T_J = 150^\circ\text{C}$

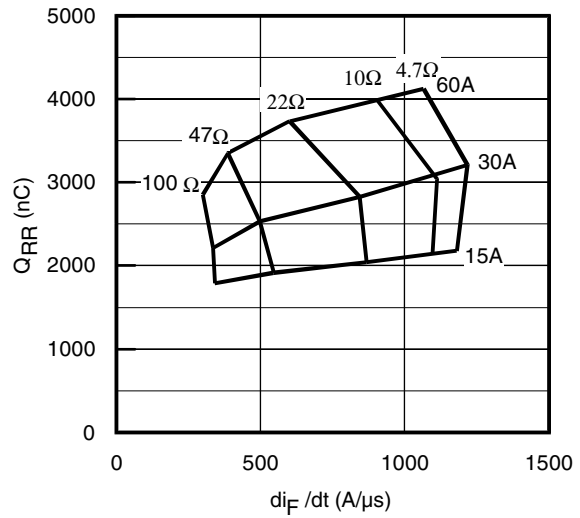

Fig. 20 - Typical Diode Q_{RR}
 $V_{CC} = 400\text{V}$; $V_{GE} = 15\text{V}$; $T_J = 150^\circ\text{C}$

IRGP30B60KD-E

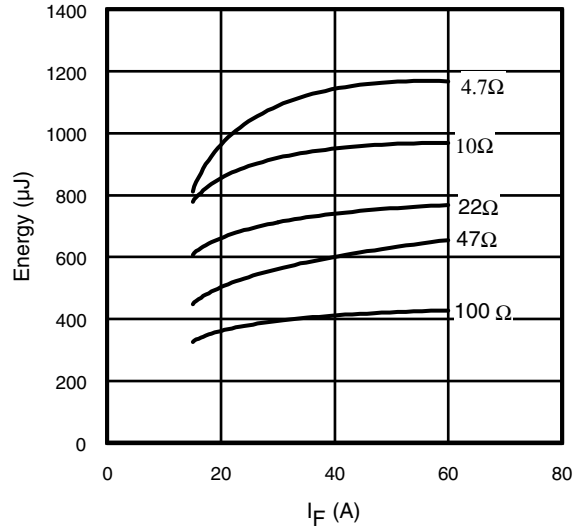

Fig. 21 - Typical Diode E_{RR} vs. I_F
 $T_J = 150^\circ\text{C}$

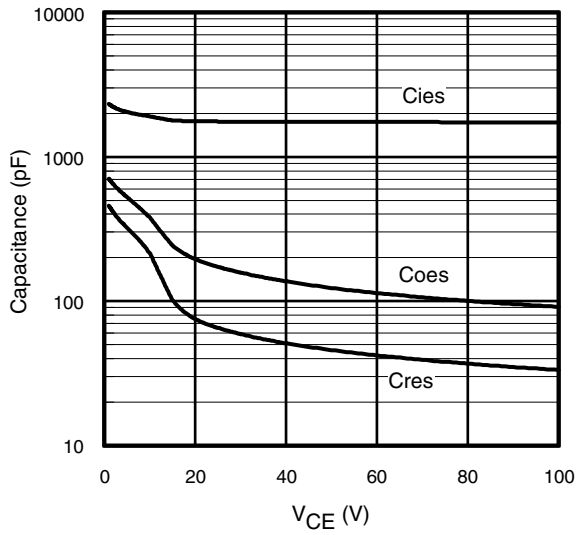

Fig. 22- Typ. Capacitance vs. V_{CE}
 $V_{GE} = 0\text{V}$; $f = 1\text{MHz}$

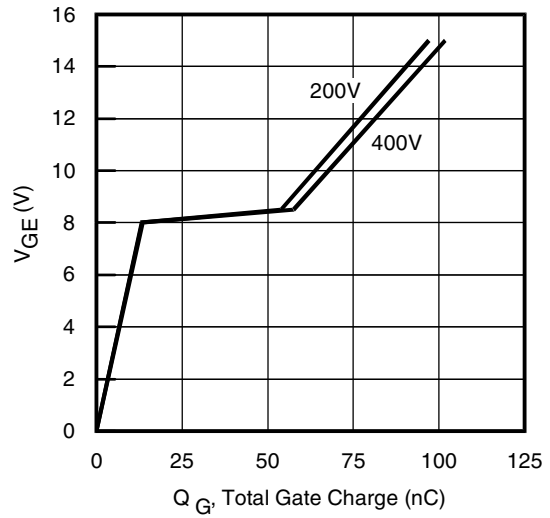

Fig. 23 - Typical Gate Charge vs. V_{GE}
 $I_{CE} = 30\text{A}$; $L = 600\mu\text{H}$

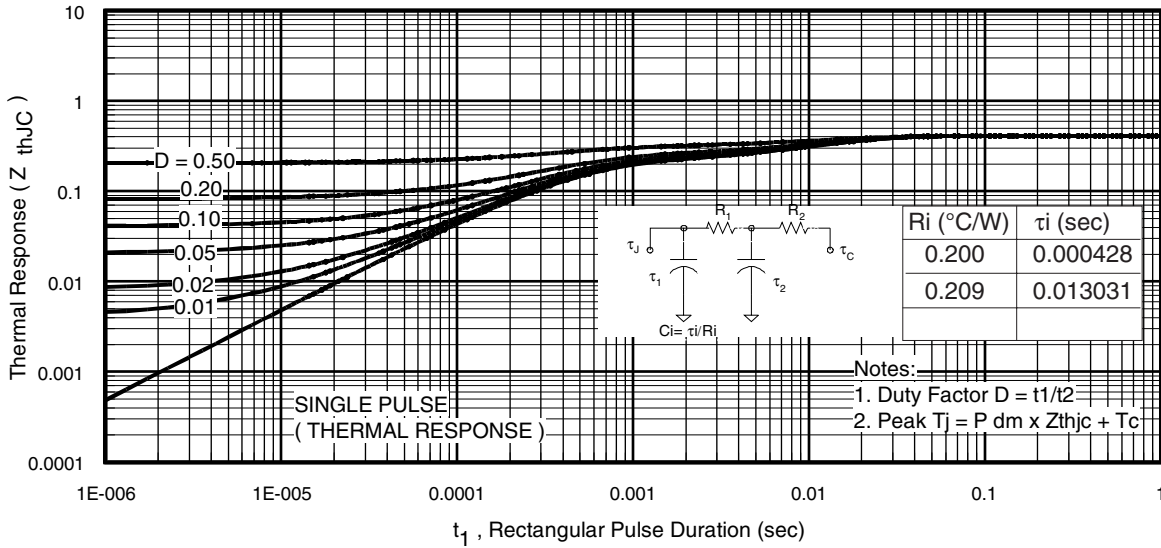

Fig 24. Maximum Transient Thermal Impedance, Junction-to-Case (IGBT)

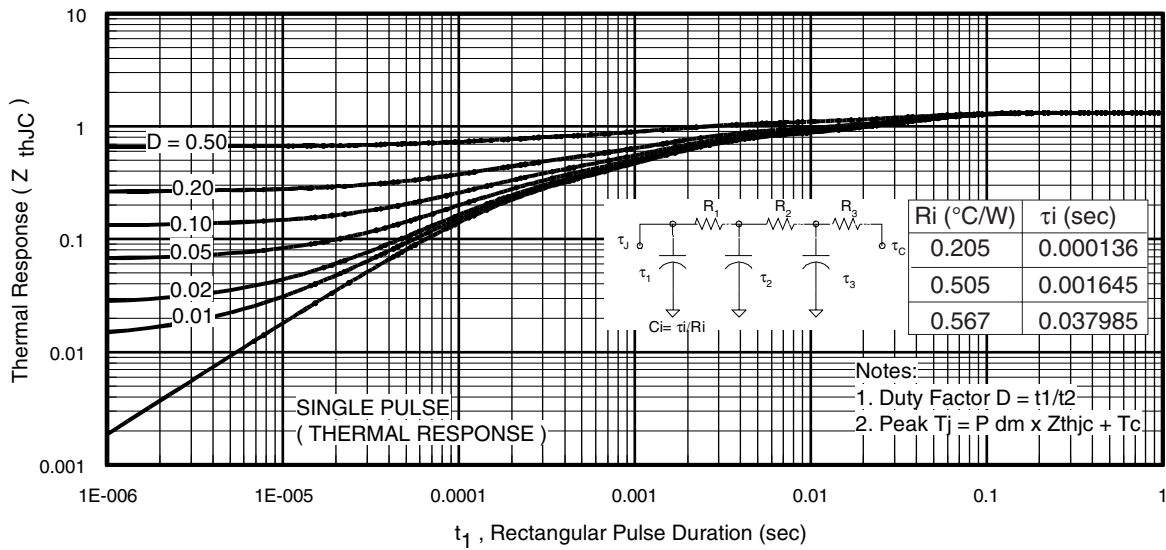

Fig 25. Maximum Transient Thermal Impedance, Junction-to-Case (DIODE)

IRGP30B60KD-E

International
IR Rectifier

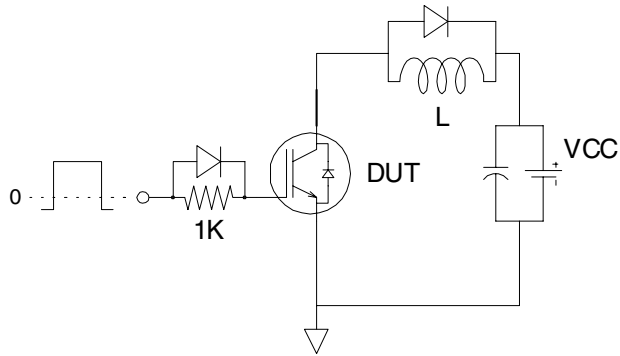

Fig.C.T.1 - Gate Charge Circuit (turn-off)

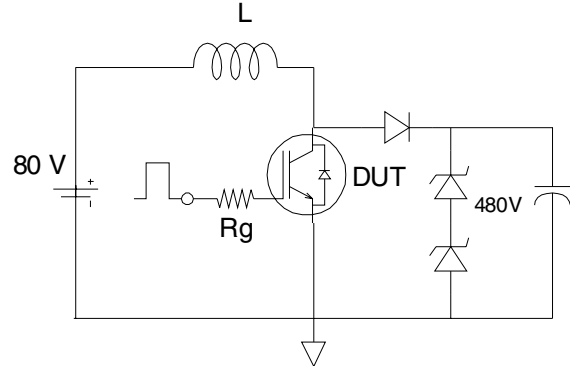

Fig.C.T.2 - RBSOA Circuit

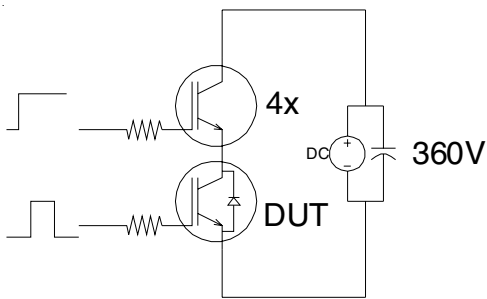

Fig.C.T.3 - S.C.SOA Circuit

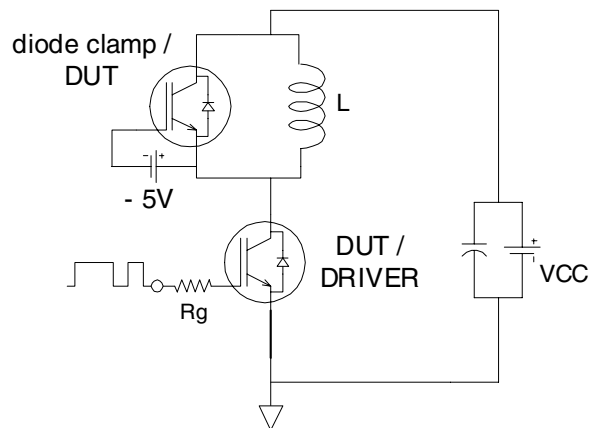

Fig.C.T.4 - Switching Loss Circuit

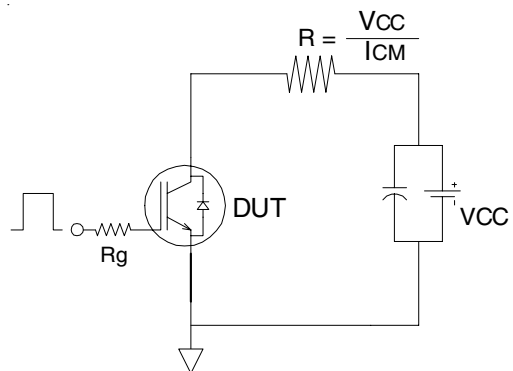

Fig.C.T.5 - Resistive Load Circuit

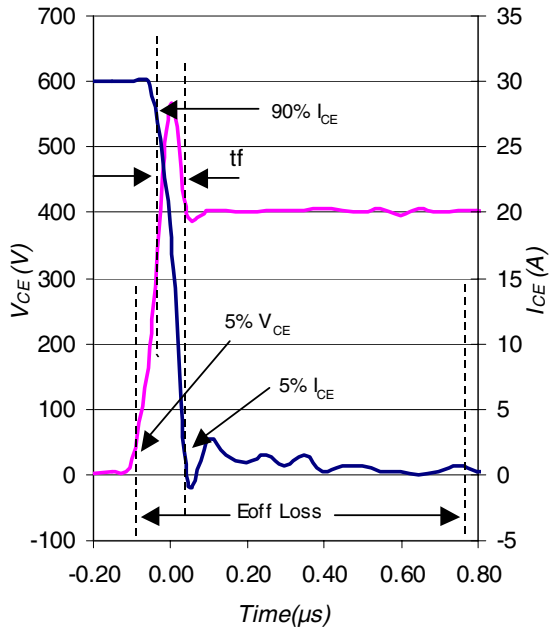

Fig. WF1- Typ. Turn-off Loss Waveform
@ $T_J = 150^\circ\text{C}$ using Fig. CT.4

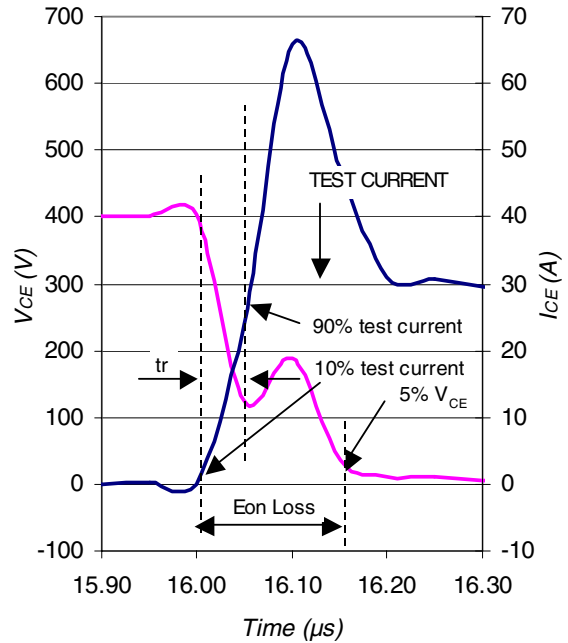

Fig. WF2- Typ. Turn-on Loss Waveform
@ $T_J = 150^\circ\text{C}$ using Fig. CT.4

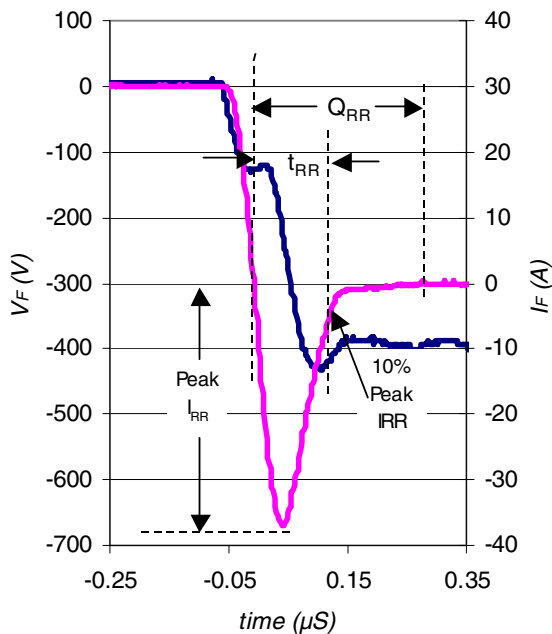

Fig. WF3- Typ. Diode Recovery Waveform
@ $T_J = 150^\circ\text{C}$ using Fig. CT.4

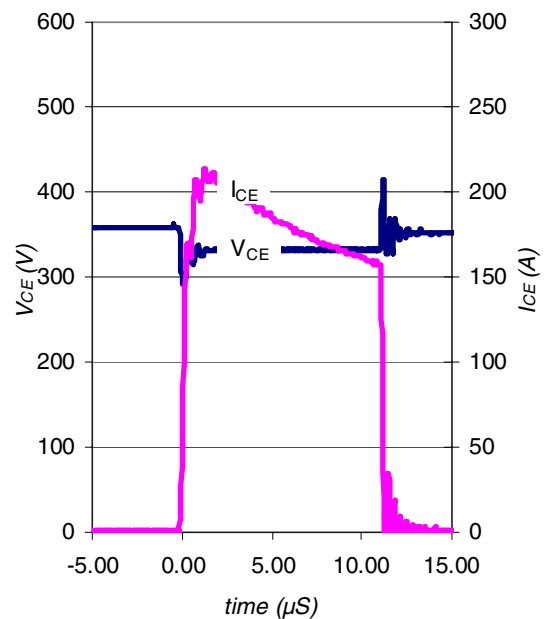
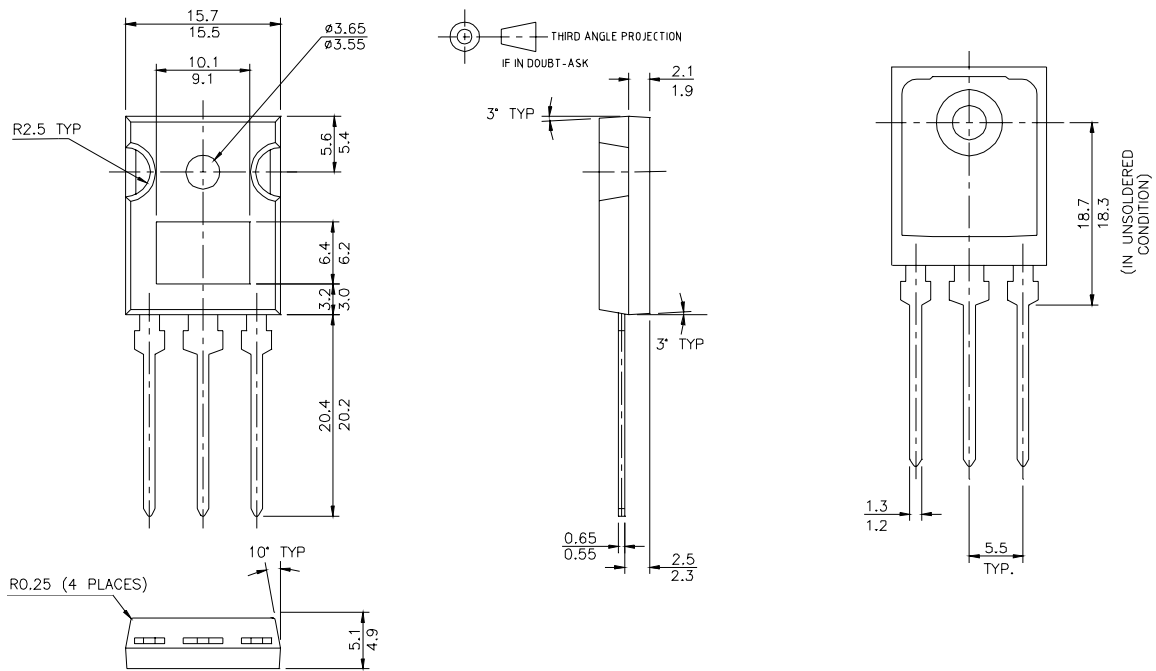

Fig. WF4- Typ. S.C Waveform
@ $T_C = 150^\circ\text{C}$ using Fig. CT.3

IRGP30B60KD-E

International
IR Rectifier

TO-247AD Case Outline and Dimensions



TO-247AD package is not recommended for Surface Mount Application.

Data and specifications subject to change without notice.
This product has been designed and qualified for Industrial market.
Qualification Standards can be found on IR's Web site.

International
IR Rectifier

IR WORLD HEADQUARTERS: 233 Kansas St., El Segundo, California 90245, USA Tel: (310) 252-7105
TAC Fax: (310) 252-7903

Visit us at www.irf.com for sales contact information. 10/02

www.irf.com