

Compact Power Relay

1 Pole—25A for Automotive Applications

FTR-G1 Series

RoHS compliant

■ FEATURES

- Compact for high density packaging (70% volume of previous generation FTR-P3 series)
- High contact capacity with proven contact material (min. 100,000 operations, 14V, 25A achieved, even with reduced size)
- Coil power savings (640mW nominal achieved with state-of-the-art magnetic analysis/design)
- Ease of PCB layout (all terminals on perimeter, coil and contact terminals separated)
- Lower noise (57dB average at 5cm)
- RoHS compliant since beginning of production. Please see page 7 for more information



■ ORDERING INFORMATION

[Example] FTR-G1 C N 010 W1
 (a) (b) (c) (d) (e)

(a)	Series Name	FTR-G1: FTR-G1 Series
(b)	Contact Arrangement	C : 1Form C
(c)	Contact Gap	N : 0.3mm gap
(d)	Nominal Coil Voltage	009 : 09 VDC 010 : 010 VDC 012 : 012 VDC
(e)	Contact Material	W1 : Silver-tin oxide-indium
(f)	Custom Designation	To be assigned custom designation

Note: The designation name is stamped on the top of the relay case as follows:
 Example: Ordering part number: FTR-G1CN010W1
 Stamped on part number: G1CN010W1

■ TYPICAL APPLICATIONS

- Power window
- Door lock
- Sun roof
- Power seat
- Wiper/IWW
- Tilt steering
- Retractable antenna

FTR-G1 SERIES

■ SPECIFICATIONS

Item		FTR-G1	
Contact	Arrangement	1 form C	
	Material	Silver-tin oxide-indium	
	Contact Path Voltage Drop (initial)	Maximum 100 mΩ (at 6 VDC 1A after stabilization)	
	Rating	25 A at 14VDC (locked motor load)	
	Maximum Carry Current	25 A / 1 hour (25°C, 100% rated coil voltage)	
	Maximum Inrush Current (reference)	35A	
Coil	Operating Ambient Temperature Range	-40°C to +85°C (no frost)	
	Storage Temperature Range	-40°C to +100°C (no frost)	
Time Values	Operate (at nominal voltage)	Maximum 10 ms (not including bounce)	
	Release (at nominal voltage)	Maximum 5 ms (not including bounce, no diode)	
Life	Mechanical	1x10 ⁶ operations minimum	
	Electrical	1) 100x10 ³ operation minimum, 14VDC, 25A inrush power window motor (1 operation: 1 forward and 1 reverse) 2) 200x10 ³ ops min., 14 VDC, 19A inrush, 12A break power window motor 3) 100x10 ³ ops. min. 14VDC, 20A inrush door locked motor	
Other	Vibration Resistance	Misoperation 10-55HZ, 1.5mm double amplitude	
	Shock Resistance	Misoperation	100 m/s ² minimum (10G)
		Endurance	1,000 m/s ² minimum (100G)
	Insulation Resistance (initial)	Max. 100 MΩ @500 VDC	
	Dielectric Withstanding Voltage (initial)	500 VAC	
	Weight	Approximately 3.5g	

■ COIL DATA CHART

FTR-G1 Series

Model	Nominal Coil Voltage	Coil Resistance (±10% at 20°C)	Must Operate Voltage	Must Release Voltage (at 20°C)	Coil Power at Nominal Voltage
FTR-G1CN009W1	9VDC	126	5.4VDC (at 20°C) 6.8VDC (at 20°C)	0.75VDC	0.64W
FTR-G1CN010W1	10VDC	160	6.5VDC (at 20°C) 8.2VDC (at 20°C)	0.8VDC	0.64W
FTR-G1CN012W1	12VDC	225	7.3VDC (at 20°C) 9.2VDC (at 20°C)	1.0VDC	0.64W

FTR-G1 SERIES

■ DIMENSIONS

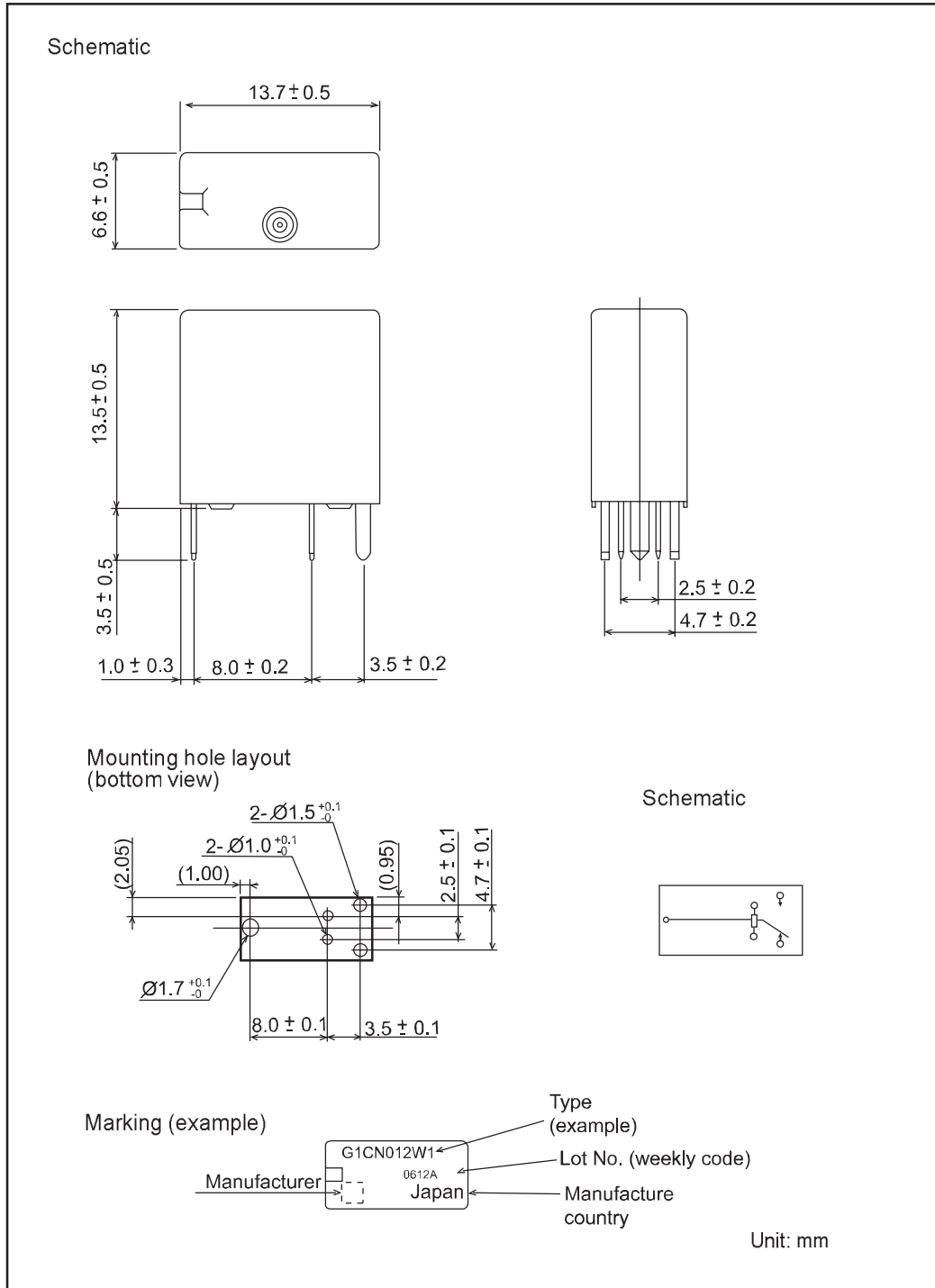

FTR-G1 SERIES

■ REFERENCE DATA

1. Pick-up & Drop-out Voltage Distributio

P/N: FTR-G1CN012W1

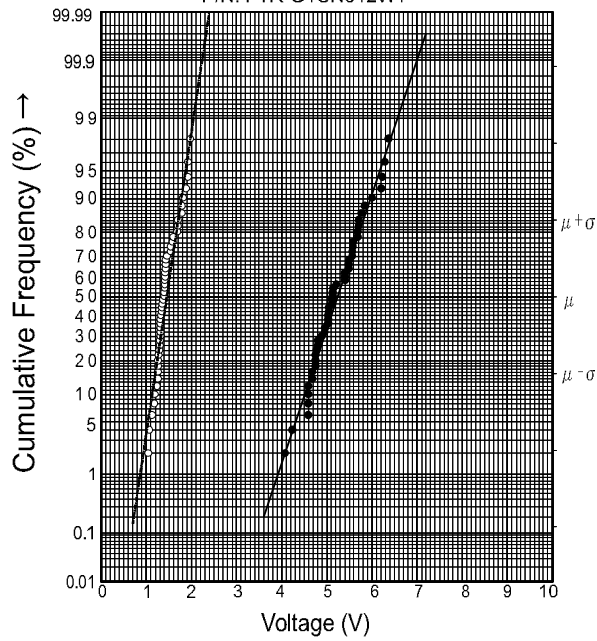

Remarks: ● Pick-up Voltage Spec. 7.3V or less
 ○ Drop-out Voltage Spec. 1.0 or more
 Sample: 50 pieces
 Temperature: 20°C

2. Contact Resistance Distribution

P/N: FTR-G1CN012W1

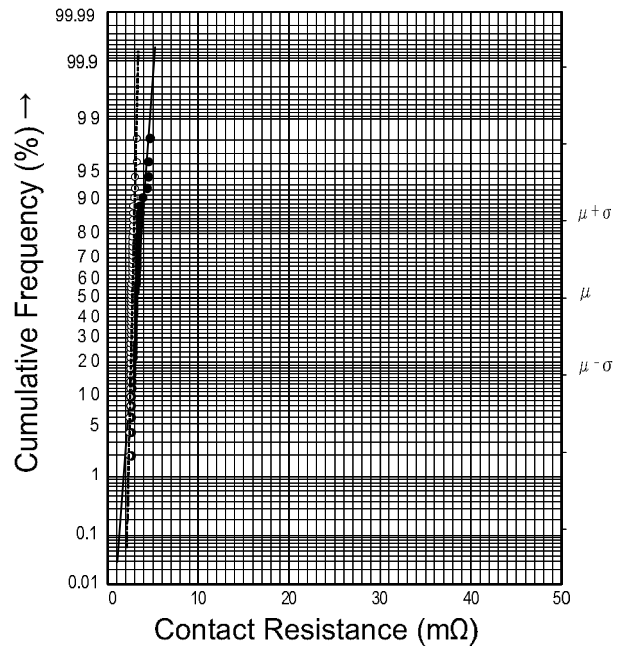

Remarks: ● N.O. contact Spec. 100mΩ or less at 6VDC, 1A, wet
 ○ N.C. contact
 Sample: 50 pieces
 Temperature: 20°C

FTR-G1 SERIES

3. Electrical Life Test 3.1 Power Window Motor Lock

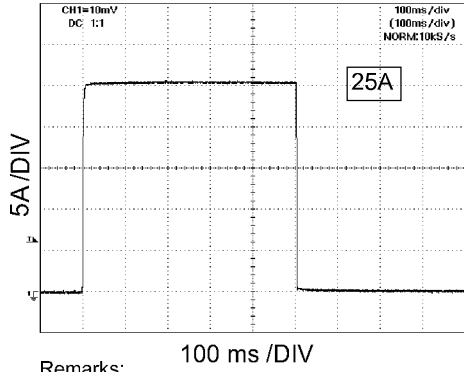

Remarks:
 V Supply: 14VDC
 Duty: 0.5 sec. ON / 9.5 sec. OFF
 Cycles: 100,000
 Temperature: 25°C
 Sample: 6 pieces

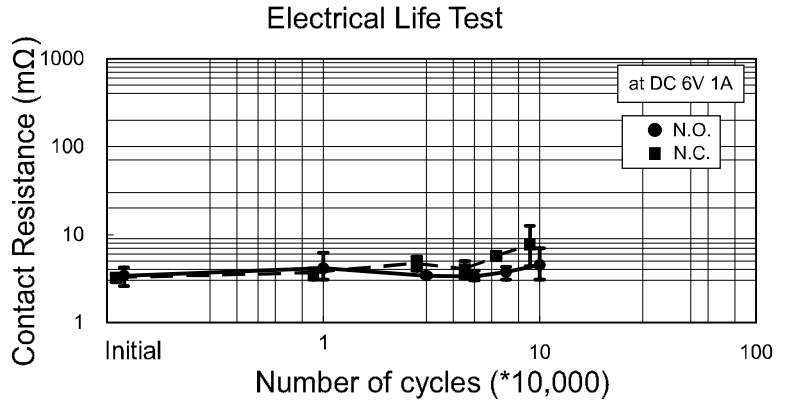

3.2 Electrical Life Test

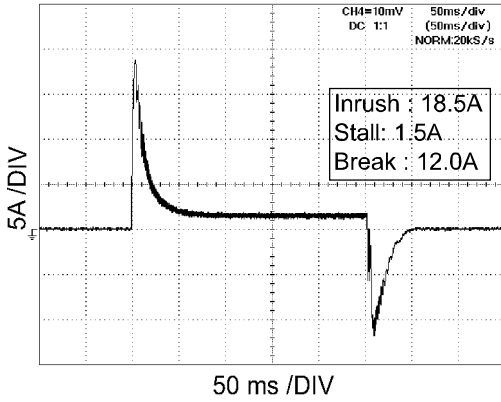

Remarks:
 V Supply: 14VDC
 Duty: 0.25 sec. ON / 9.75 sec. OFF
 Cycles: 100,000
 Temperature: 25°C
 Sample: 6 pieces

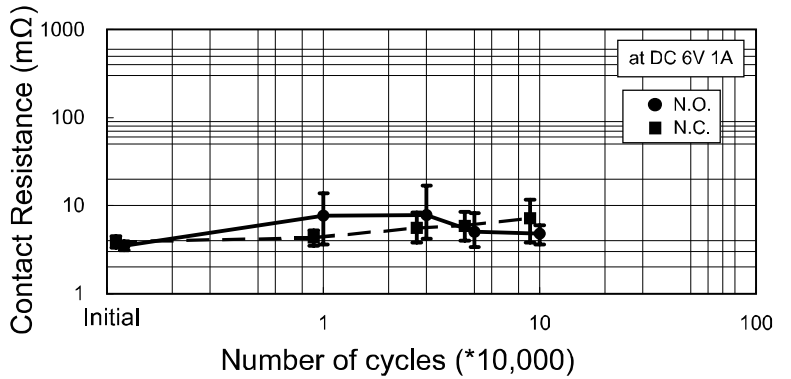

FTR-G1 SERIES

4. Carrying Current Capacity

P/N: FTR-G1CN012W1

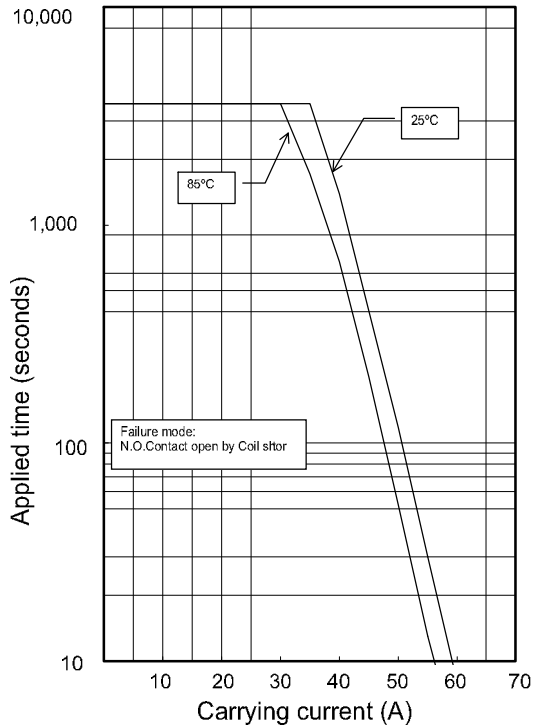

Remarks:
 Applied coil voltage: 14VDC
 The electric wire is soldered directly with the terminal.
 (Wire size: AWG12)

5. Operating Range

P/N: FTR-G1CN012W1

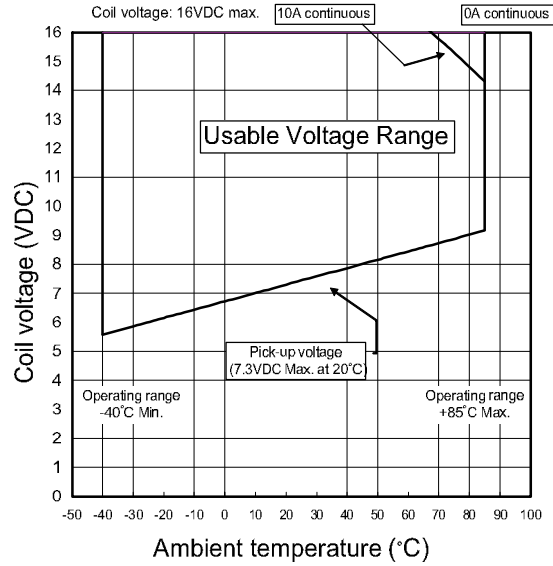

6. Coil Temperature Rise Test 1

P/N: FTR-G1CN012W1 (25°C)

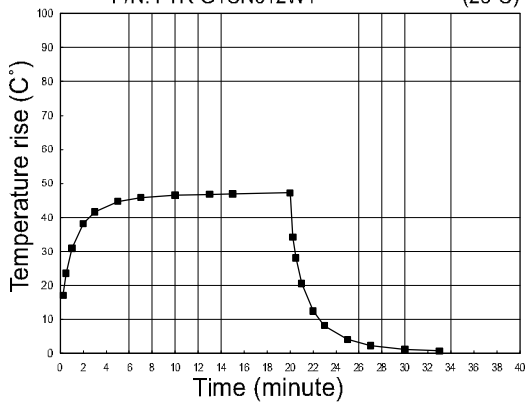

Remarks:
 Applied coil voltage: 12VDC
 Carrying current: 0A

7. Coil Temperature Rise Test 1

P/N: FTR-G1CN012W1 (25°C)

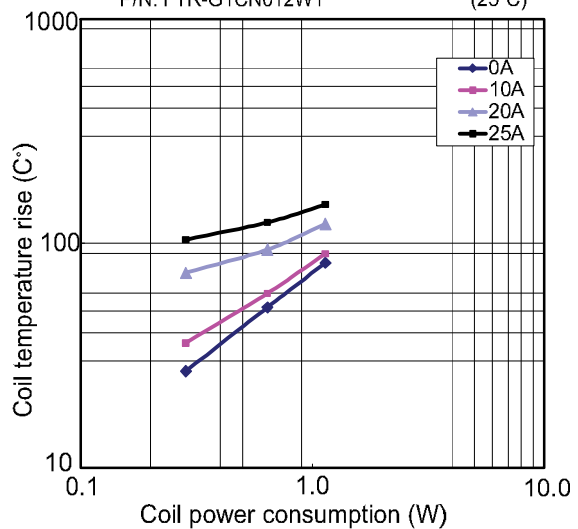

RoHS Compliance and Lead Free Relay Information

1. General Information

- Relays produced after the specific date code that is indicated on each data sheet are lead-free now. Most of our signal and power relays are lead-free. Please refer to Lead-Free Status Info. (<http://www.fujitsu.com/us/downloads/MICRO/fcai/relays/lead-free-letter.pdf>)
- Lead free solder paste currently used in relays is Sn-3.0Ag-0.5Cu.
- All signal and most power relays also comply with RoHS. Please refer to individual data sheets. Relays that are RoHS compliant do not contain the 5 hazardous materials that are restricted by RoHS directive (lead, mercury, chromium IV, PBB, PBDE).
- It has been verified that using lead-free relays in leaded assembly process will not cause any problems (compatible).
- "LF" is marked on each outer and inner carton. (No marking on individual relays).
- To avoid leaded relays (for lead-free sample, etc.) please consult with area sales office.
- We will ship leaded relays as long as the leaded relay inventory exists.

Note: Cadmium was exempted from RoHS on October 21, 2005. (Amendment to Directive 2002/95/EC)

2. Recommended Lead Free Solder Profile

- Recommended solder paste Sn-3.0Ag-0.5Cu.

Flow Solder condition:

Pre-heating:	maximum 120°C
Soldering:	dip within 5 sec. at 260°C solder bath

Solder by Soldering Iron:

Soldering Iron	
Temperature:	maximum 360°C
Duration:	maximum 3 sec.

We highly recommend that you confirm your actual solder conditions

3. Moisture Sensitivity

- Moisture Sensitivity Level standard is not applicable to electromechanical relays.

4. Tin Whisker

- Dipped SnAgCu solder is known as low risk tin whisker. No considerable length whisker was found by our in house test.

FTR-G1 SERIES

Fujitsu Components International Headquarter Offices

Japan

Fujitsu Component Limited
Gotanda-Chuo Building
3-5, Higashigotanda 2-chome, Shinagawa-ku
Tokyo 141, Japan
Tel: (81-3) 5449-7010
Fax: (81-3) 5449-2626
Email: promothq@ft.ed.fujitsu.com
Web: www.fcl.fujitsu.com

North and South America

Fujitsu Components America, Inc.
250 E. Caribbean Drive
Sunnyvale, CA 94089 U.S.A.
Tel: (1-408) 745-4900
Fax: (1-408) 745-4970
Email: marcom@fcai.fujitsu.com
Web: <http://www.fujitsu.com/us/services/edevices/components/>

Europe

Fujitsu Components Europe B.V.
Diamantlaan 25
2132 WV Hoofddorp
Netherlands
Tel: (31-23) 5560910
Fax: (31-23) 5560950
Email: info@fceu.fujitsu.com
Web: <http://www.fujitsu.com/emea/services/components/>

Asia Pacific

Fujitsu Components Asia Ltd.
102E Pasir Panjang Road
#04-01 Citilink Warehouse Complex
Singapore 118529
Tel: (65) 6375-8560
Fax: (65) 6273-3021
Email: fcal@fcal.fujitsu.com
Web: <http://www.fujitsu.com/sg/services/micro/components/>

©2006 Fujitsu Components America, Inc. All rights reserved. All trademarks or registered trademarks are the property of their respective owners.

Fujitsu Components America does not warrant that the content of datasheet is error free. In a continuing effort to improve our products Fujitsu Components America, Inc. reserves the right to change specifications/datasheets without prior notice. Rev. 01/18/2006.