

Powerex, Inc., 200 Hillis Street, Youngwood, Pennsylvania 15697-1800 (412) 925-7272
 Powerex, Europe, S.A. 428 Avenue G. Durand, BP107, 72003 Le Mans, France (43) 41.14.14

Phase Control SCR
 490 Amperes Average
 2400 Volts

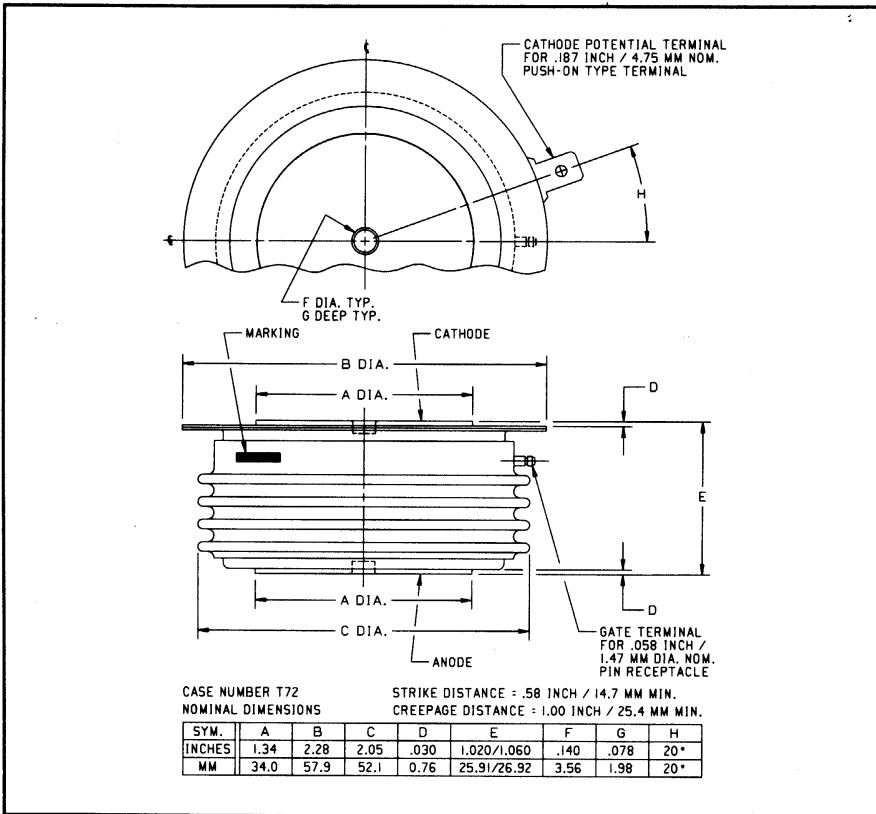

C391 (Outline Drawing)

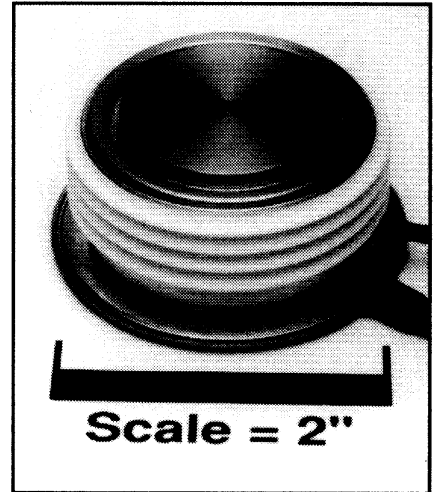

C391 Phase Control SCR
 490 Amperes Average, 2400 Volts

Description:

Powerex Silicon Controlled Rectifiers (SCR) are designed for phase control applications. These are all-diffused, Press-Pak (Pow-R-Disc) devices employing the field-proven amplifying (di/namic) gate.

Features:

- Low On-State Voltage
- High di/dt
- High dv/dt
- Hermetic Packaging
- Excellent Surge and I^2t Ratings

Applications:

- Power Supplies
- Battery Chargers
- Motor Control
- VAR Generators

Ordering Information:

Select the complete six digit part number you desire from the table, i.e. C391LD is a 2400 Volt, 490 Ampere Phase Control SCR.

Type	Voltage		Current
	V_{DRM}	V_{RRM} Code	$I_{T(av)}$
C391	1400	PD	490
	1600	PM	
	1800	PN	
	2000	L	
	2200	LB	
	2400	LD	



Powerex, Inc., 200 Hillis Street, Youngwood, Pennsylvania 15697-1800 (412) 925-7272
 Powerex, Europe, S.A. 428 Avenue G. Durand, BP107, 72003 Le Mans, France (43) 41.14.14

C391

Phase Control SCR

490 Amperes Average, 2400 Volts

Absolute Maximum Ratings

	Symbol	C391	Units
RMS On-State Current @ $T_C = 64^\circ\text{C}$	$I_{T(RMS)}$	770	Amperes
Average On-State Current @ $T_C = 64^\circ\text{C}$	$I_{T(av)}$	490	Amperes
Peak One-Cycle Surge (Non-Repetitive) On-State Current (60Hz)	I_{TSM}	8000	Amperes
Peak One-Cycle Surge (Non-Repetitive) On-State Current (50Hz)	I_{TSM}	7000	Amperes
Critical Rate-of-Rise of On-State Current (Non-Repetitive)	di/dt	150	Amperes/ μs
Critical Rate-of-Rise of On-State Current (Repetitive)	di/dt	75	Amperes/ μs
I^2t (for Fusing), One Cycle at 60Hz	I^2t	265,000	A^2sec
Peak Gate Power Dissipation	P_{GM}	200	Watts
Average Gate Power Dissipation	$P_{G(av)}$	5	Watts
Storage Temperature	T_{STG}	-40 to +150	$^\circ\text{C}$
Operating Temperature	T_J	-40 to +125	$^\circ\text{C}$
Mounting Force		2000 to 2500	lb.
Mounting Force		8.9 to 11.1	kN

Electrical and Thermal Characteristics

Characteristics	Symbol	Test Conditions	C391	Units
Voltage—Blocking State Maximums				
Forward Leakage, Peak	I_{DRM}	$T_J = 125^\circ\text{C}$, Rated V_{DRM}	45	mA
Reverse Leakage, Peak	I_{RRM}	$T_J = 125^\circ\text{C}$, Rated V_{RRM}	45	mA
Current—Conducting State Maximums				
Peak On-State Voltage	V_{TM}	$I_{TM} = 3000\text{A}$ Peak, Duty Cycle $\leq 0.01\%$, $T_C = 25^\circ\text{C}$	2.65	Volts
Switching				
Typical Turn-Off Time	t_q	$T_J = 125^\circ\text{C}$; $I_{TM} = 500$ Amps; $V_R = 50$ Volts Min.; $.8 \times V_{DRM}$ (Reapplied); Rate-of-Rise of Reapplied Off-State Voltage = $20\text{V}/\mu\text{sec}$ (linear); Commutation $di/dt = 25$ Amps/ μsec ; Repetition Rate = 1 pps; Gate Bias During Turn-Off Interval = 0 Volts, 100Ω	200	μsec
Typical Delay Time	t_d	$T_J = 25^\circ\text{C}$, $I_{TM} = 50$ Adc, V_{DRM} Rated. Gate Supply: 20 Volts, 20Ω , $0.1 \mu\text{sec}$ Max. Rise Time	1	μsec
Min. Critical dv/dt exponential to V_{DRM}	dv/dt	$0.8V_{DRM}$ Rated, $T_J = 125^\circ\text{C}$	200	$\text{V}/\mu\text{sec}$
Thermal				
Maximum Thermal Resistance, double sided cooling				
Junction to Case	$R_{\theta JC}$		0.06	$^\circ\text{C}/\text{Watt}$
Case to Sink, Lubricated	$R_{\theta CS}$		0.02	$^\circ\text{C}/\text{Watt}$
Gate—Maximum Parameters				
Gate Current to Trigger	I_{GT}	$V_D = 6\text{Vdc}$, $T_C = 25^\circ\text{C}$, $R_L = 3\Omega$	150	mA
Gate Voltage to Trigger	V_{GT}	$T_C = -40$ to $+125^\circ\text{C}$, $V_D = 6\text{Vdc}$, $R_L = 3\Omega$	5	Volts
Non-Triggering Gate Voltage	V_{GDM}	$V = \text{rated } V_{DRM}$, $T_C = 125^\circ\text{C}$, $R_L = 1000\Omega$	0.15	Volts
Peak Forward Gate Current	I_{GTM}		10	Amperes
Peak Reverse Gate Voltage	V_{GRM}		5	Volts

Powerex, Inc., 200 Hillis Street, Youngwood, Pennsylvania 15697-1800 (412) 925-7272
 Powerex, Europe, S.A. 428 Avenue G. Durand, BP107, 72003 Le Mans, France (43) 41.14.14

C391
 Phase Control SCR
 490 Amperes Average, 2400 Volts

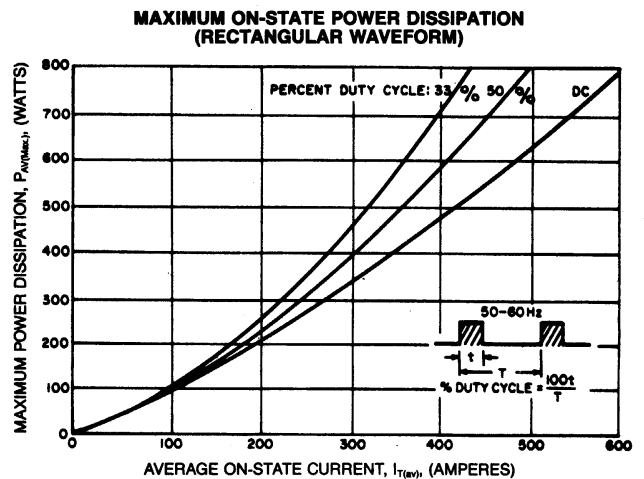
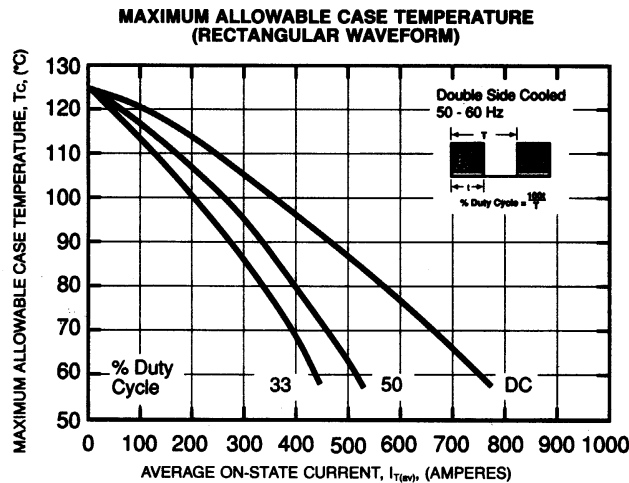
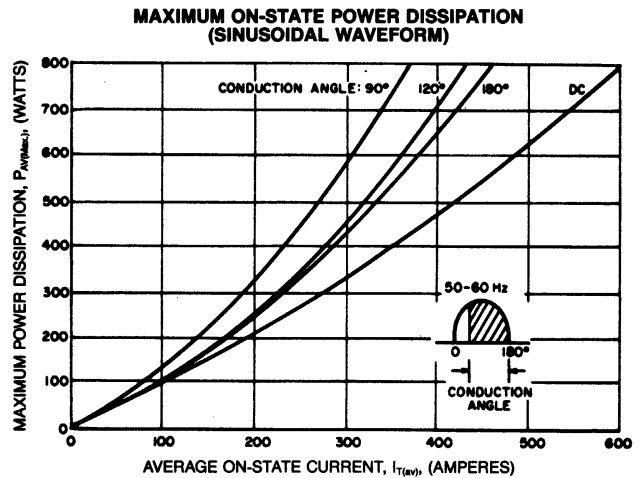
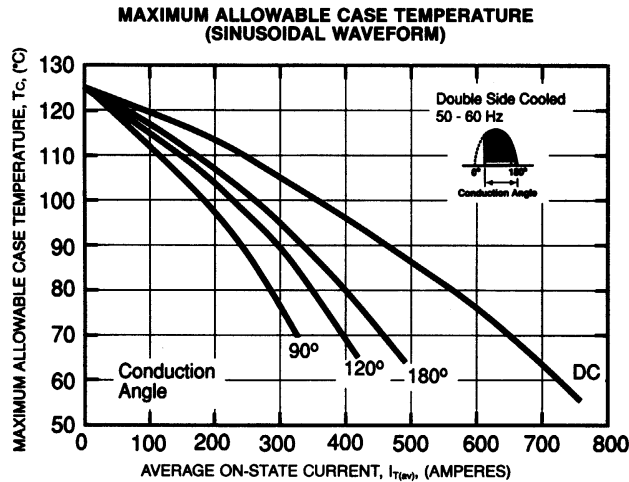
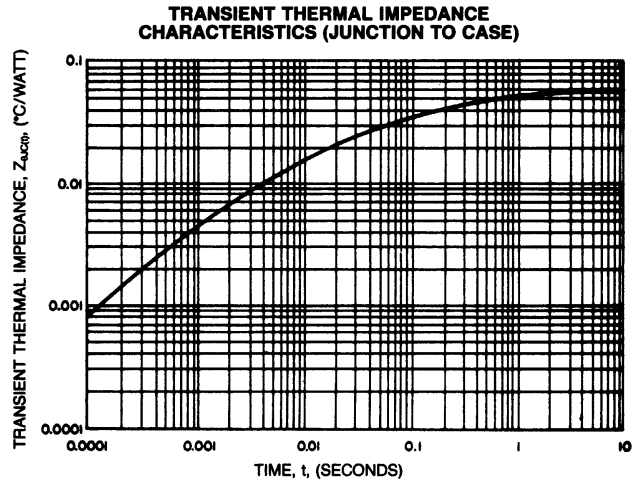
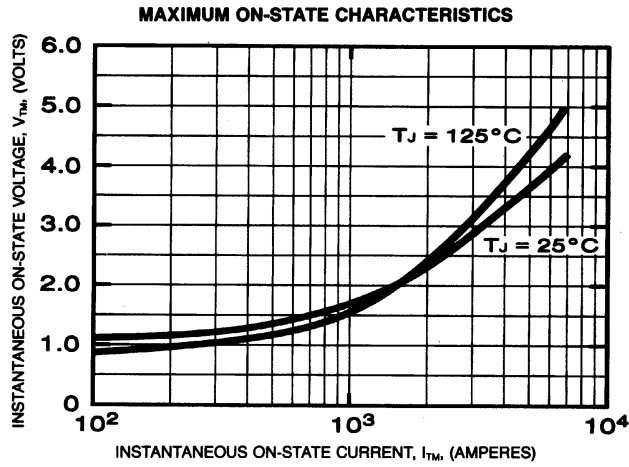

Powerex, Inc., 200 Hillis Street, Youngwood, Pennsylvania 15697-1800 (412) 925-7272
 Powerex, Europe, S.A. 428 Avenue G. Durand, BP107, 72003 Le Mans, France (43) 41.14.14

C391
Phase Control SCR
 490 Amperes Average, 2400 Volts

MAXIMUM ALLOWABLE CASE TEMPERATURE (SINUSOIDAL WAVEFORM)

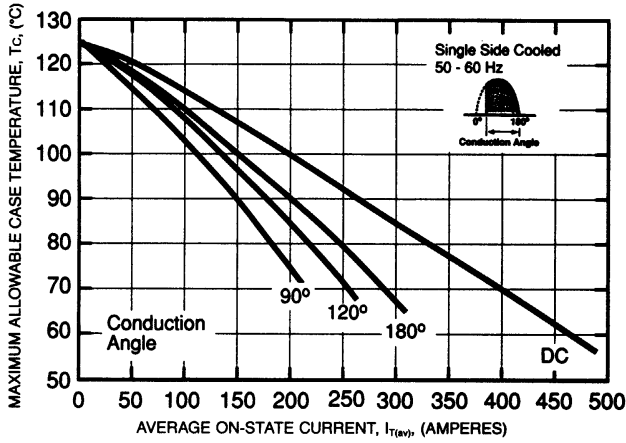

MAXIMUM ALLOWABLE CASE TEMPERATURE (RECTANGULAR WAVEFORM)

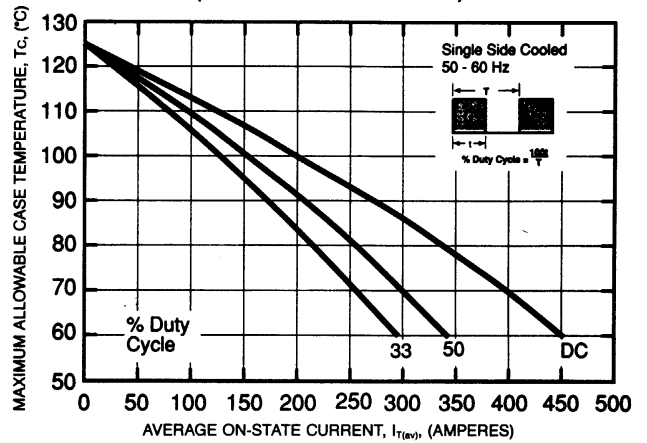

MAXIMUM ON-STATE POWER DISSIPATION (SINUSOIDAL WAVEFORM — EXTENDED)

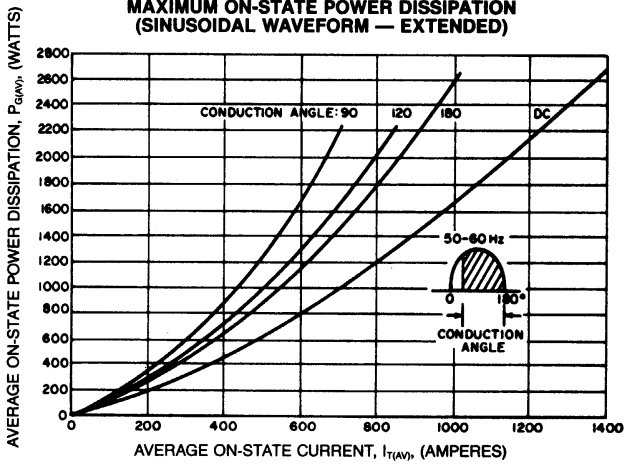

MAXIMUM ON-STATE POWER DISSIPATION (RECTANGULAR WAVEFORM — EXTENDED)

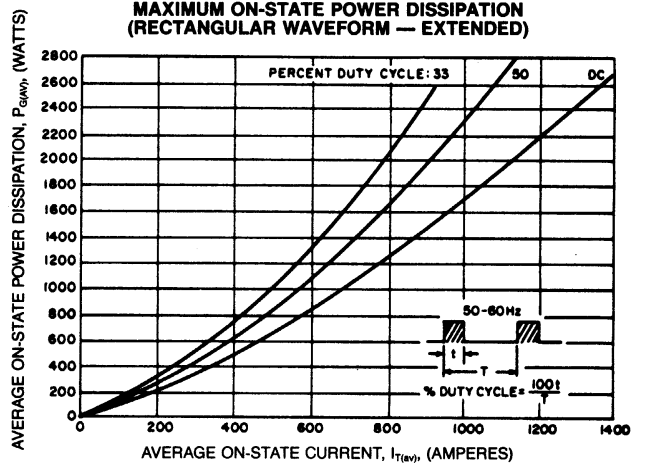

SUB-CYCLE SURGE AND I^2t RATINGS (RATED LOAD CONDITIONS)

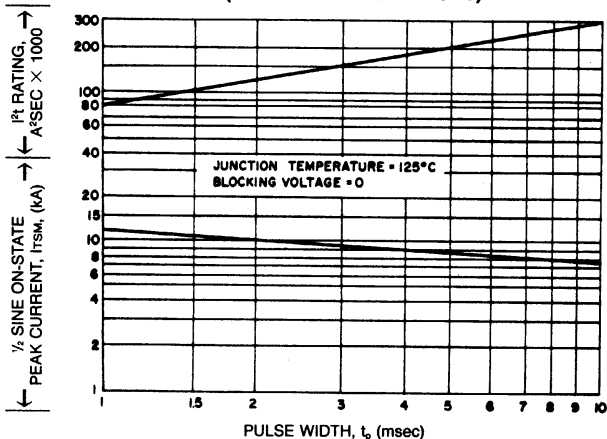

GATE CHARACTERISTICS

