

# Precision Adjustable Shunt Regulator

## Monolithic IC MM1530 AT/AN

### Outline

The MM1530AT/AN is 3-terminal adjustable shunt regulator, which provides a highly accurate 0.8% bandgap reference voltage. The output voltage can be adjusted to any value between reference voltage  $V_{REF}$  and 12 volts with two external resistors. Moreover, there are a lot of ranges of the application as a zener diode besides the replacement is possible because it has steep turn-on characteristics.

### Features

- |                                   |                            |
|-----------------------------------|----------------------------|
| 1. Reference voltage tolerance    | $V_{REF}=1.260V\pm0.8\%$   |
| 2. Output voltage can be adjusted | $V_{REF}\leq V_o\leq 12V$  |
| 3. Low Dynamic Output Impedance   | $ Z_{KA} =0.13\Omega$ typ. |

### Package

TO-92 (TAPING)  
SOT-25A

### Pin Assignment

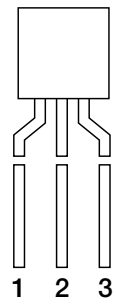

TO-92 (TAPING)

1	Reference
2	Anode
3	Cathode

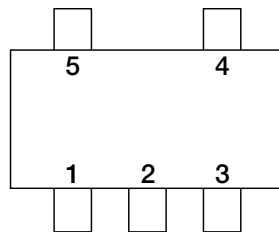

SOT-25A (TOP VIEW)

1	NC
2	SUB
3	Cathode
4	Reference
5	Anode

note: The second terminal is SUB, so connect the terminal to GND.

**Equivalent Circuit Diagram**

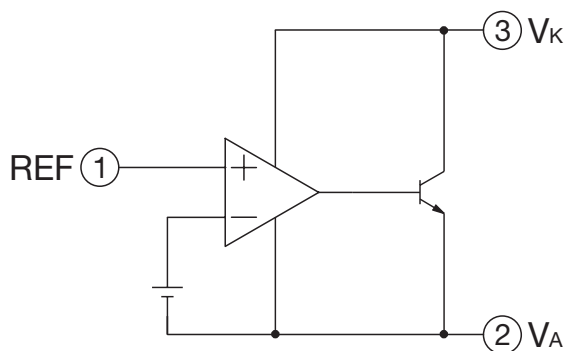

\* TO-92 Package

**Absolute Maximum Ratings** (Ambient Temperature,  $T_a=25^{\circ}\text{C}$ )

Item	Symbol	Ratings	Unit
Operating Temperature	$T_{OPR}$	-30~+85	$^{\circ}\text{C}$
Storage Temperature	$T_{STG}$	-40~+125	$^{\circ}\text{C}$
Cathode to Anode voltage	$V_{KA}$	12	V
Cathode current	$I_K$	50	mA
Reference input current	$I_{REF}$	50	$\mu\text{A}$
Allowable loss	$P_d$	500 (TO-92) 150 (SOT-25A)	mW

**Recommended Operating Conditions** (Ambient Temperature,  $T_a=25^{\circ}\text{C}$ )

Cathode to Anode voltage	$V_{KA}$	$V_{REF}\sim 12$	V
Cathode current	$I_K$	1~30	mA

**Electrical Characteristics** (Ambient Temperature,  $T_a=25^\circ\text{C}$ )

Item	Symbol	Measurement conditions	Min.	Typ.	Max.	Unit
Reference voltage	$V_{REF}$	$V_{KA}=V_{REF}$	1.250	1.260	1.270	V
Reference voltage deviation over temperature range	$\Delta V_{REF}/\Delta T_a$	$V_{KA}=V_{REF}$ $T_a=0\sim+70^\circ\text{C}$		3	12	mV
Load regulation	$\Delta V_{REF}/\Delta V_{KA}$	$\Delta V_{KA}=V_{REF}$ , $ V_{REF}  \leq V_{KA} \leq 5V$		1.0	2.7	mV/V
		$5V \leq V_{KA} \leq 12V$		1.0	2.0	mV/V
Reference input current	$I_{REF}$	$V_{KA}=V_{REF}$ $R_1=10K$ , $R_2=\infty$		2	4	$\mu\text{A}$
Reference input current deviation over temperature range	$\Delta I_{REF}/\Delta T_a$	$V_{KA}=V_{REF}$ , $R_1=10K$ , $R_2=\infty$ $T_a=0\sim+70^\circ\text{C}$		0.3	1.2	$\mu\text{A}$
Minimum Cathode Current	$I_{Kmin.}$	$V_{KA}=V_{REF}$ , $\Delta V_{REF}=2\%$		0.15	0.3	mA
Off-state Cathode Current	$I_{OFF}$	$V_{KA}=12V$ , $V_{REF}=0V$		0.1	1.0	$\mu\text{A}$
Dynamic Impedance	$ Z_{KA} $	$V_{KA}=V_{REF}$ , $f \leq 1\text{kHz}$ $I_K=1\sim 30\text{mA}$		0.13	0.5	$\Omega$

**Measuring Circuit**

(1)  $V_{KA}=V_{REF}$

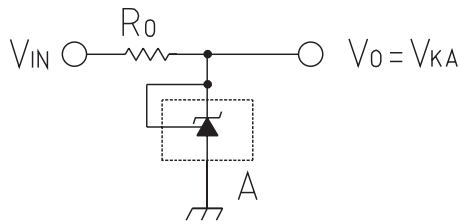

(3)  $I_{OFF}$

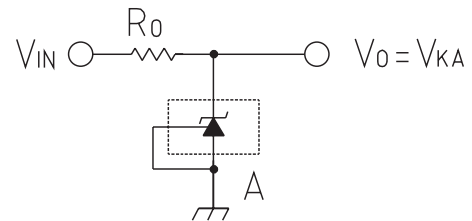

(2)  $V_{KA} \geq V_{REF}$   $V_0=V_{KA}=V_{REF}$

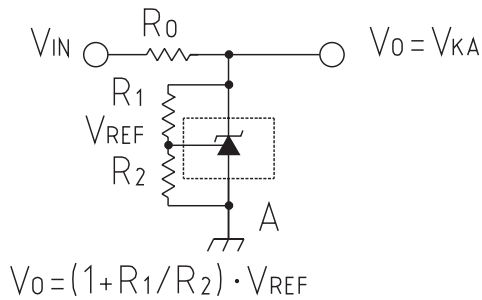

(4) Open Loop Voltage Gain

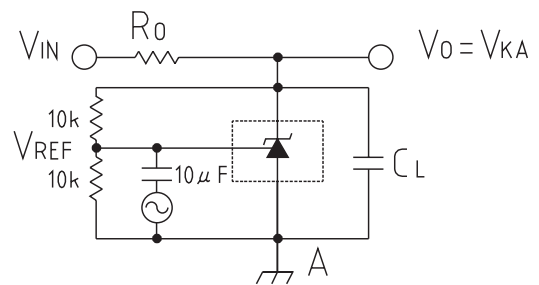

Characteristics

High Voltage Operating Characteristics

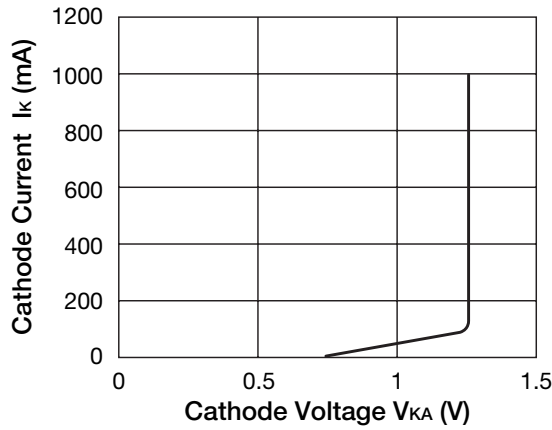

Input Current

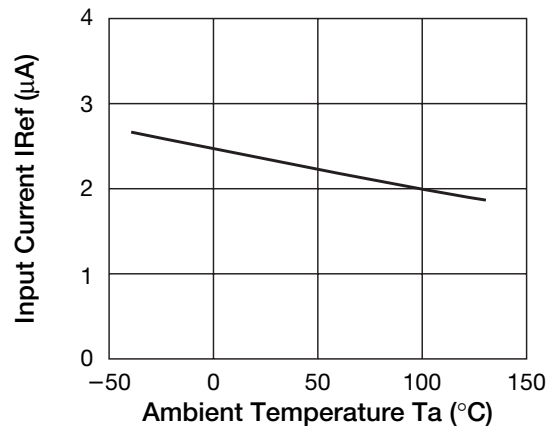

Low Current Operating Characteristics

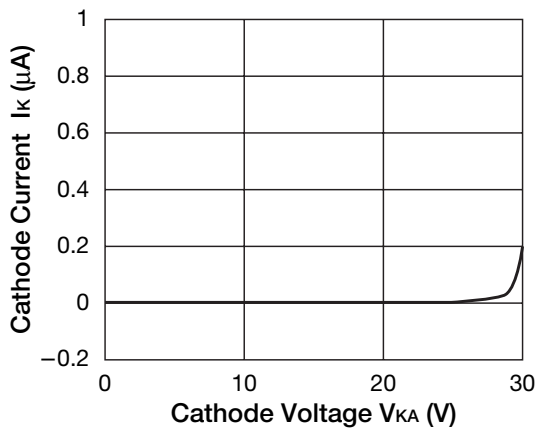

Reference Voltage

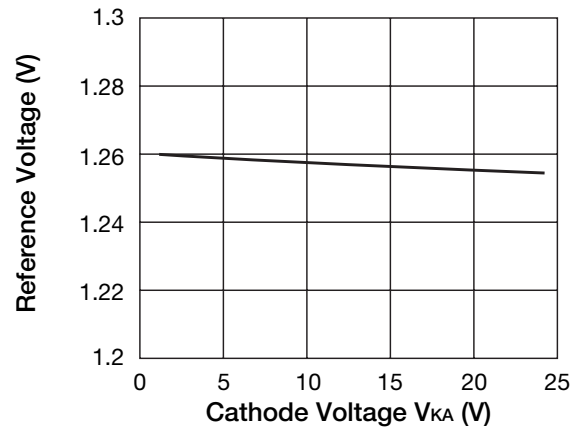

Detection Voltage Character

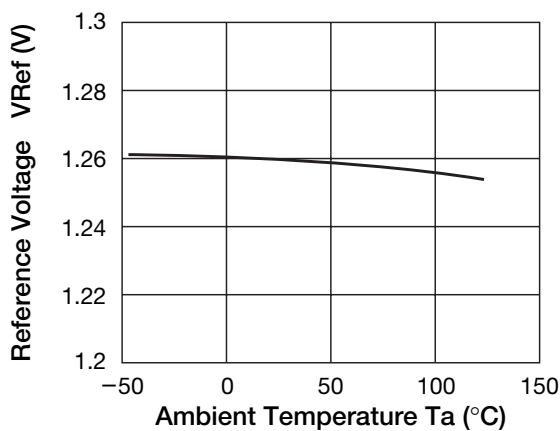

Off State Leakage

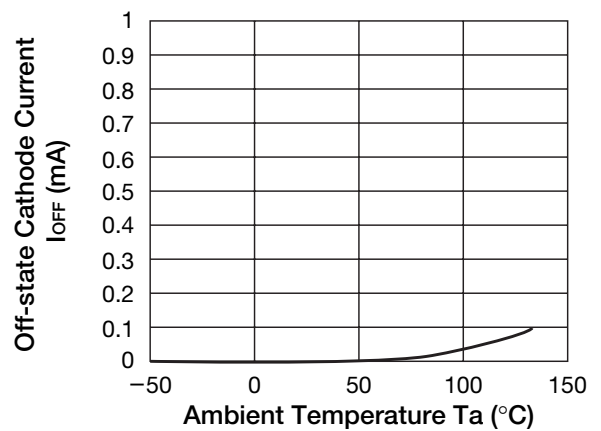

■ Dynamic Output Impedance

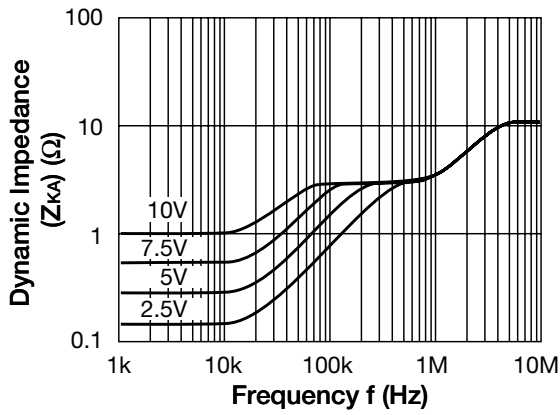

■ Open loop Voltage Gain · Phase

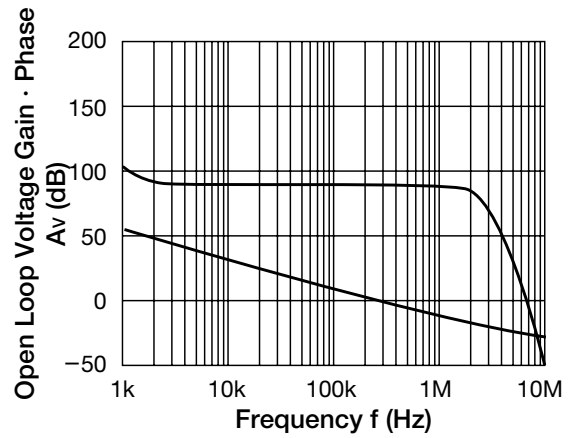

■ Pulse Response

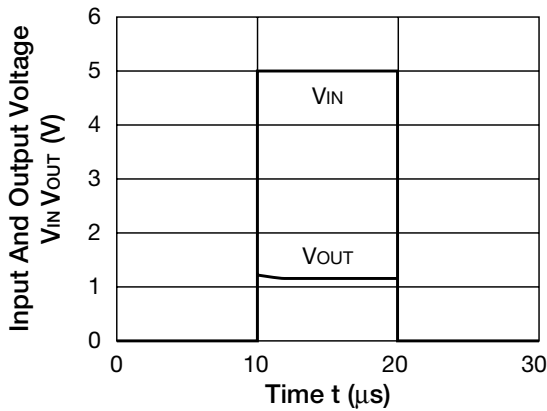

■ Stability Boundary Conditions

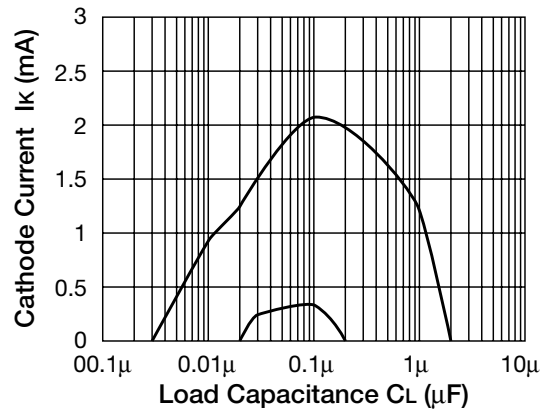

Notes concerning stability operation region

The MM1431AT/AN requires external capacitors for regulator stability. These capacitors must be correctly selected for good performance.