

NPN Transistors

 Lead(Pb)-Free

TO-92

1. EMITTER
 2. COLLECTOR
 3. BASE

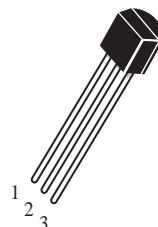

ABSOLUTE MAXIMUM RATINGS (Ta=25°C)

Rating	Symbol	2SD16116	2SD1616A	Unit
Collector-Emitter Voltage	V _{CEO}	50	60	V _{dc}
Collector-Base Voltage	V _{CBO}	60	120	V _{dc}
Emitter-Base Voltage	V _{EBO}	6.0		V _{dc}
Collector Current	I _C	1.0		A _{dc}
Total Device Dissipation T _A =25°C	P _D	0.75		W
Junction Temperature	T _j	150		°C
Storage, Temperature	T _{stg}	-55 to +150		°C

ELECTRICAL CHARACTERISTICS

Characteristics	Symbol	Min	Max	Unit
Collector-Emitter Breakdown Voltage (I _C = 2.0 mA _{dc} , I _B =0)	V _{(BR)CEO}	50 60	-	V _{dc}
Collector-Base Breakdown Voltage (I _C = 10 uA _{dc} , I _E =0)	V _{(BR)CBO}	60 120	-	V _{dc}
Emitter-Base Breakdown Voltage (I _E = 10 uA _{dc} , I _C =0)	V _{(BR)EBO}	6.0	-	V _{dc}
Collector Cutoff Current (V _{CB} =60 V _{dc} , I _E =0)	I _{CBO}	-	0.1	uA _{dc}
Emitter Cutoff Current (V _{EB} = 6.0 V _{dc} , I _C =0)	I _{EBO}	-	0.1	uA _{dc}

2SD1616
2SD1616A **WEITRON****ELECTRICAL CHARACTERISTICS** ($T_A=25^\circ\text{C}$ unless otherwise noted) (Continued)

Characteristics	Symbol	Min	TYP	Max	Unit
-----------------	--------	-----	-----	-----	------

ON CHARACTERISTICS

DC Current Gain ($I_C=100\text{ mAdc}, V_{CE}=2.0\text{ Vdc}$)	$h_{FE(1)}$	135	-	600	-
DC Current Gain ($I_C=1.0\text{ mAdc}, V_{CE}=2.0\text{ Vdc}$)	$h_{FE(2)}$	81	-	-	-
Collector-Emitter Saturation Voltage ⁽¹⁾ ($I_C=1.0\text{ mAdc}, I_B=50\text{ mAdc}$)	$V_{CE(sat)}$	-	0.15	0.3	Vdc
Base-Emitter Saturation Voltage (1) ($I_C=1.0\text{ mAdc}, I_B=50\text{ mAdc}$)	$V_{BE(sat)}$	-	0.9	1.2	Vdc
Base-Emitter on Voltage (1) ($I_C=50\text{ mA}, V_{CE}=2.0\text{ V}$)	$V_{BE(on)}$	-	0.64	0.7	Vdc
Current-Gain-Bandwidth Product ($I_C=100\text{ mAdc}, V_{CE}=2.0\text{ Vdc}, f=30\text{ MHz}$)	f_T	100	160	-	MHz
Output Capacitance ($V_{CB}=10\text{ V}, I_E=0\text{ V}, f=1\text{ MHz}$)	Cob	-	-	25	PF

SWITCHING CHARACTERISTICS

Turn-On Time	$V_{CC}=10\text{ V}, I_C=100\text{ mA}$ $I_{B1}=-I_{B2}=10\text{ mA}$ $V_{BE(OFF)}=2-3\text{ V}$	ton	-	0.07	-	us
Storage Time		ts	-	0.95	-	
Fall Time		tf	-	0.07	-	

Note:

1. Pulse Test: Pulse Width 350 us, Duty Cycle 2%.

Classification of $h_{FE(1)}$

Rank	L	K	U
Range	135-270	200-400	300-600

WEITRON<http://www.weitron.com.tw>

Typical Characteristics

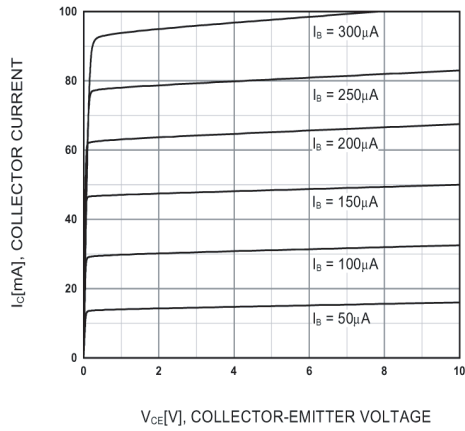

Figure 1. Static Characteristic

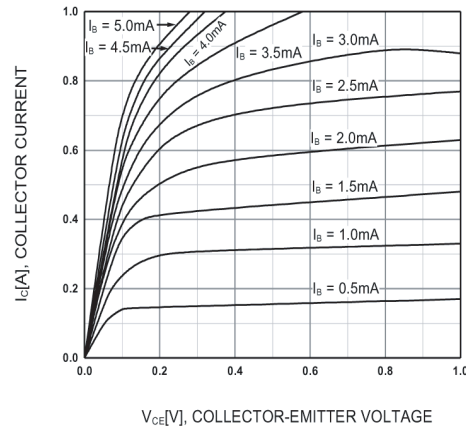

Figure 2. Static Characteristic

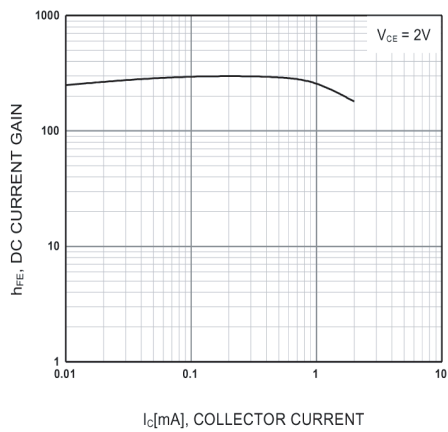
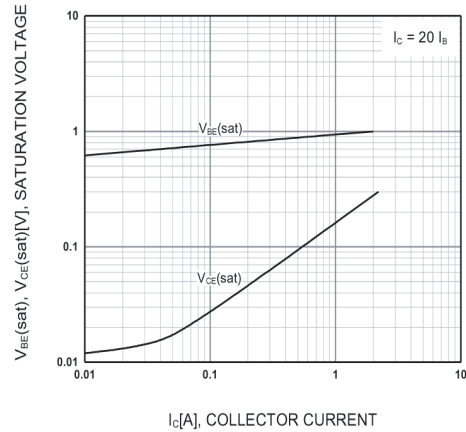

Figure 3. DC current Gain



**Figure 4. Base-Emitter Saturation Voltage
Collector-Emitter Saturation Voltage**

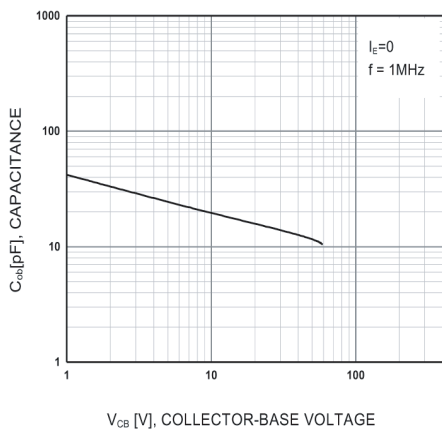

Figure 5. Collector Output Capacitance

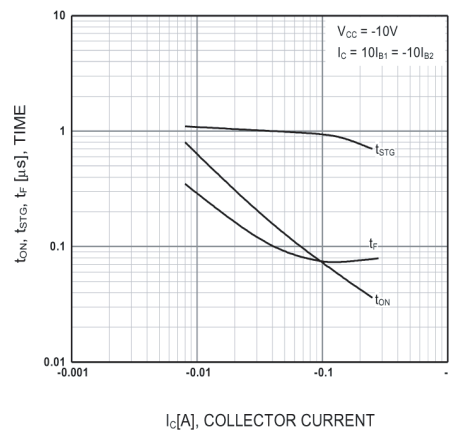

Figure 6. Switching Time

Typical Characteristics

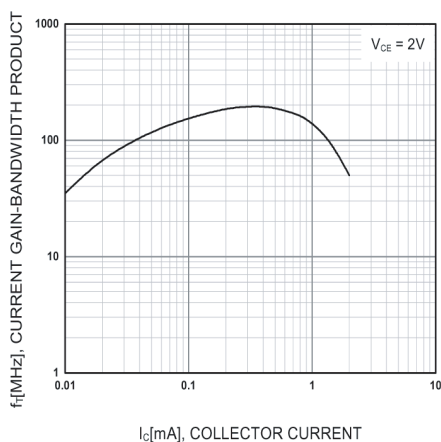

Figure 7. Current Gain Bandwidth Product

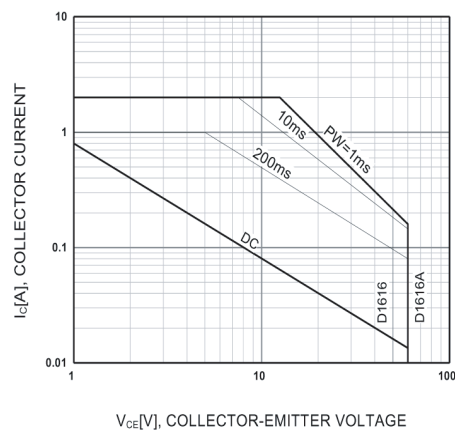

Figure 8. Safe Operating Area

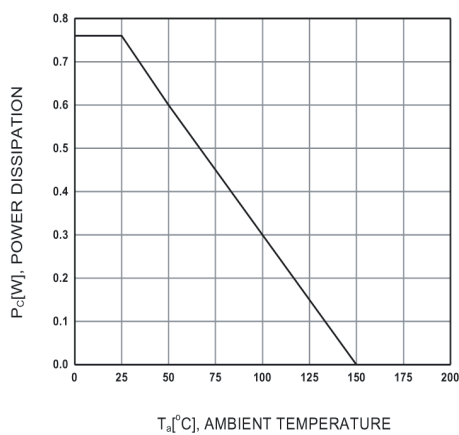
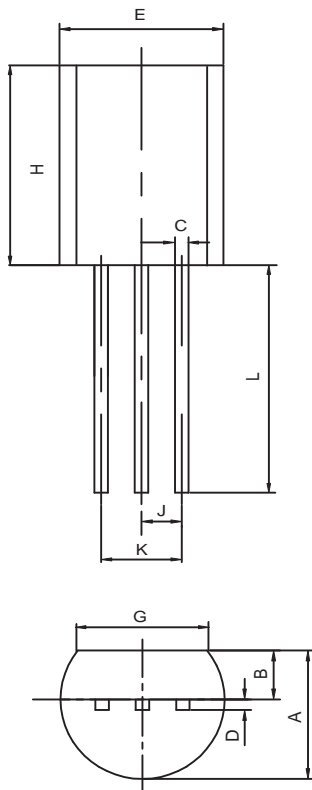

Figure 9. Power Derating

TO-92 Outline Dimensions

unit:mm



TO-92		
Dim	Min	Max
A	3.30	3.70
B	1.10	1.40
C	0.38	0.55
D	0.36	0.51
E	4.40	4.70
G	3.43	-
H	4.30	4.70
J	1.270TYP	
K	2.44	2.64
L	14.10	14.50