

**SPECIFICATIONS**

Contact Rating: Dependent upon contact material  
 Electrical Life: 40,000 make-and-break cycles at full load  
 Contact Resistance: 10 mΩ max. typical initial @ 2-4 VDC 100 mA for both silver and gold plated contacts  
 Insulation Resistance: 1,000 MΩ min.  
 Dielectric Strength: 1,000 V RMS @ sea level  
 Operating Temperature: -30° C to 85° C

**MATERIALS**

Case & Bushing: PBT  
 Pedestal of Case: LPC  
 Actuator: Brass, chrome plated with internal O-ring seal  
 Switch Support: Brass or steel tin plated  
 Contacts / Terminals: Silver or gold plated copper alloy

HOW TO ORDER

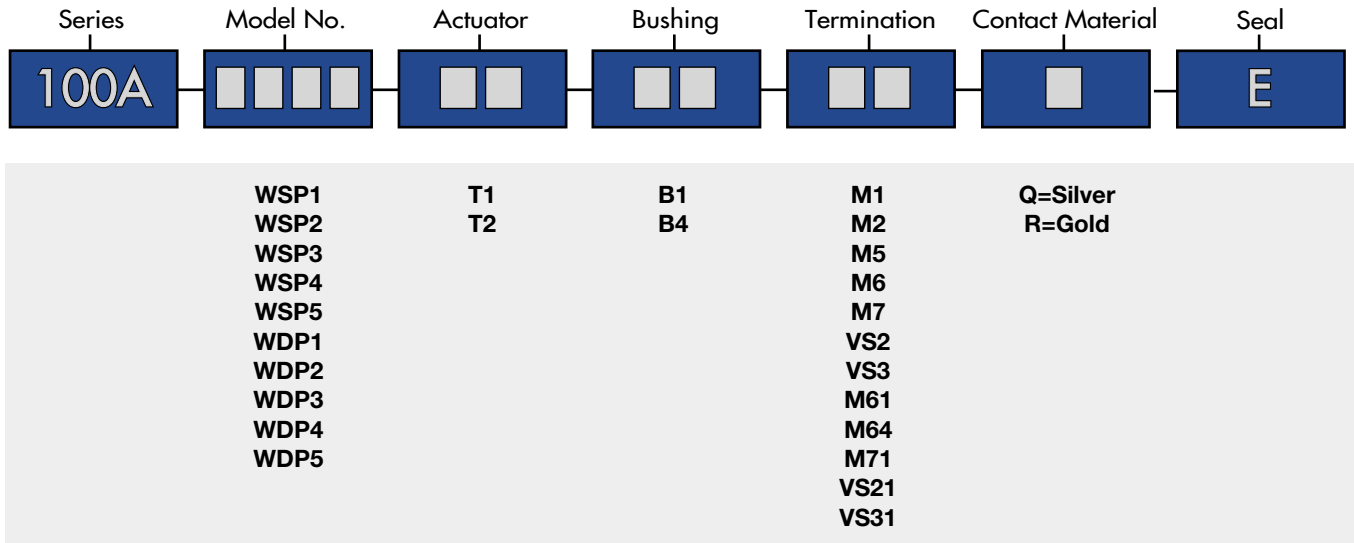

EXAMPLE

100A → WDP4 → T1 → B4 → M1 → R → E

SPECIFICATIONS SUBJECT TO CHANGE WITHOUT NOTICE.



**SPDT**

Model No.	POS 1	POS 2	POS 3
WSP-1	ON	NONE	ON
WSP-2	ON	NONE	(ON)
WSP-3	ON	OFF	ON
WSP-4	(ON)	OFF	(ON)
WSP-5	ON	OFF	(ON)
Term. Comm.	2-3	OPEN	2-1

Schematic



( ) = Momentary

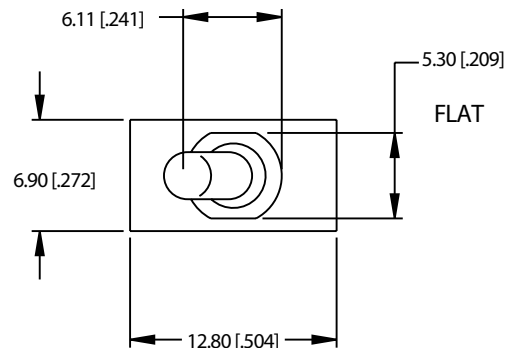

PROCESS SEALED MINIATURE TOGGLE SWITCHES

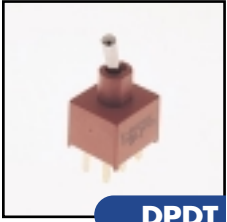

**DPDT**

Model No.	POS 1	POS 2	POS 3
WDP-1	ON	NONE	ON
WDP-2	ON	NONE	(ON)
WDP-3	ON	OFF	ON
WDP-4	(ON)	OFF	(ON)
WDP-5	ON	OFF	(ON)
Term. Comm.	2-3, 5-6	OPEN	2-1, 5-4

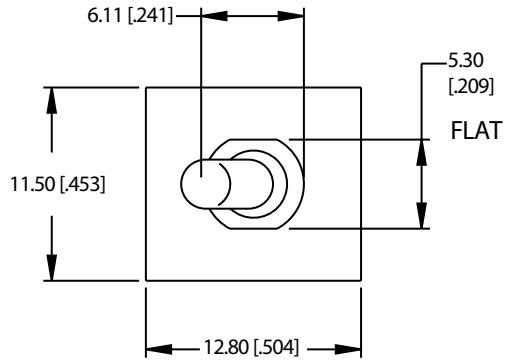
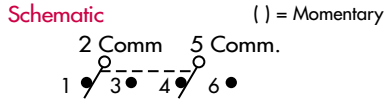

ACTUATOR OPTIONS

**T1**

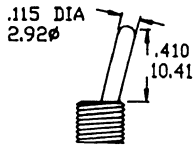

T1 actuator std. when ordered with M1 termination.  
Add 0.100 (2.54) for B4 bushing.

**T2**

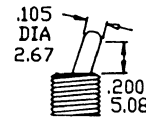

T2 actuator std. when ordered with VS, M2, M6 or M7 terminations.  
Add 0.100 (2.54) for B4 bushing.

BUSHING OPTIONS

**B1**

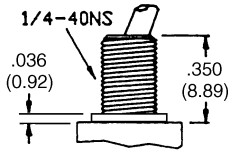

Std for M1

**B4**

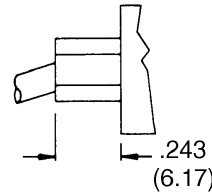

Std for M2, M6, M7, VS termination

TERMINATION OPTIONS

**M1**

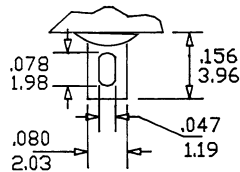

THK .030 (0.76)

**M2**

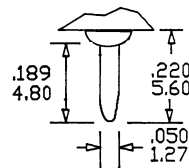

THK .030 (0.76)

SPECIFICATIONS SUBJECT TO CHANGE WITHOUT NOTICE.

# SERIES 100A SWITCHES

## PROCESS SEALED MINIATURE TOGGLE SWITCHES



**M6**  
**SPDT**

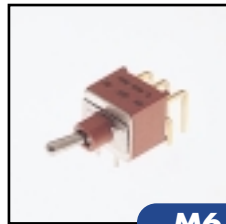
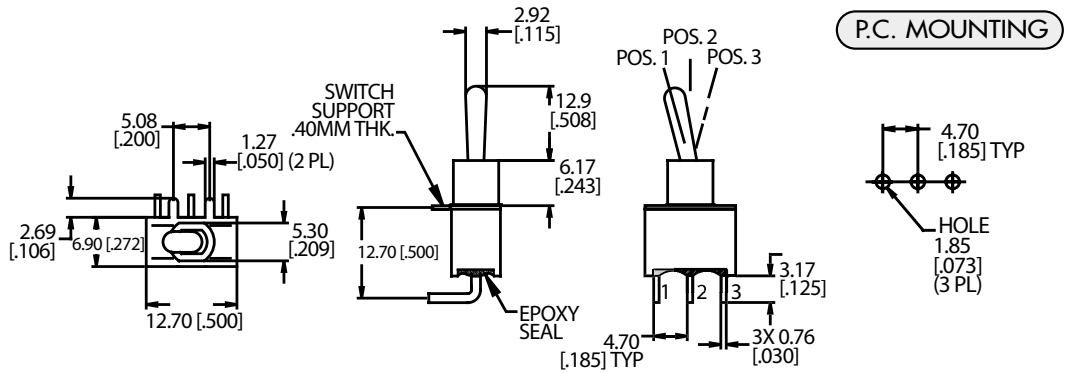

**M6**  
**DPDT**

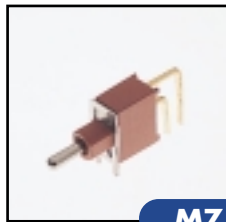
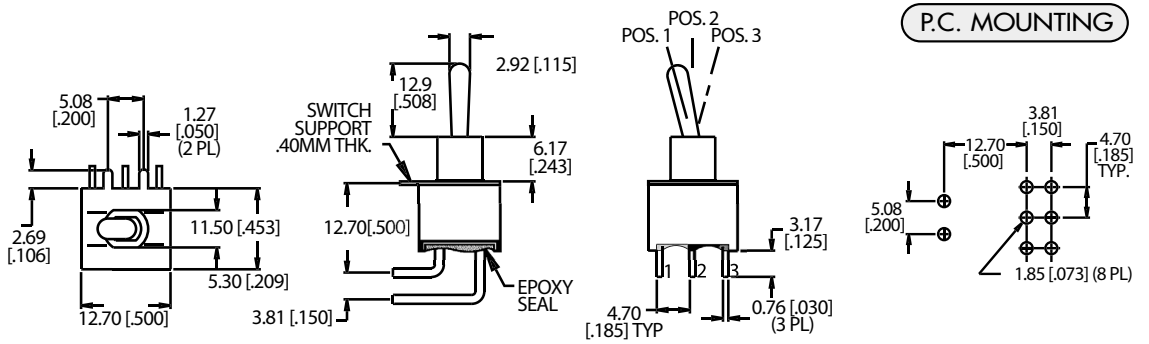

**M7**  
**SPDT**

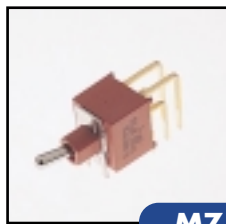
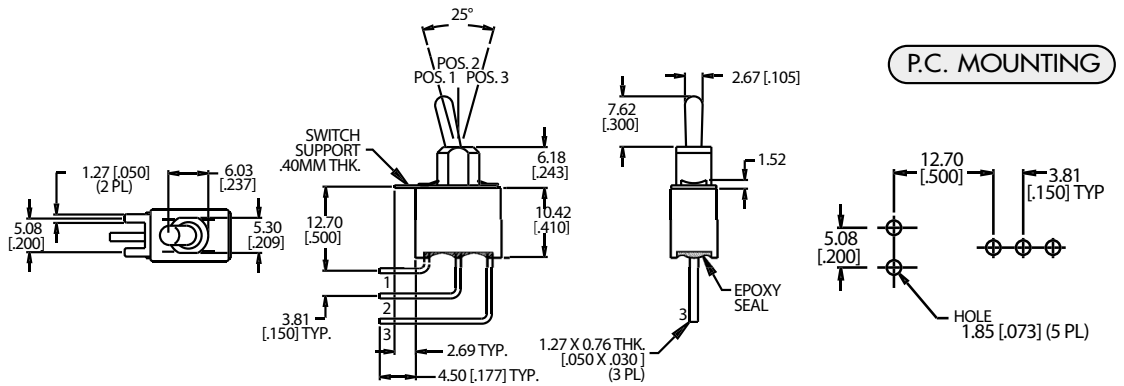

**M7**  
**DPDT**

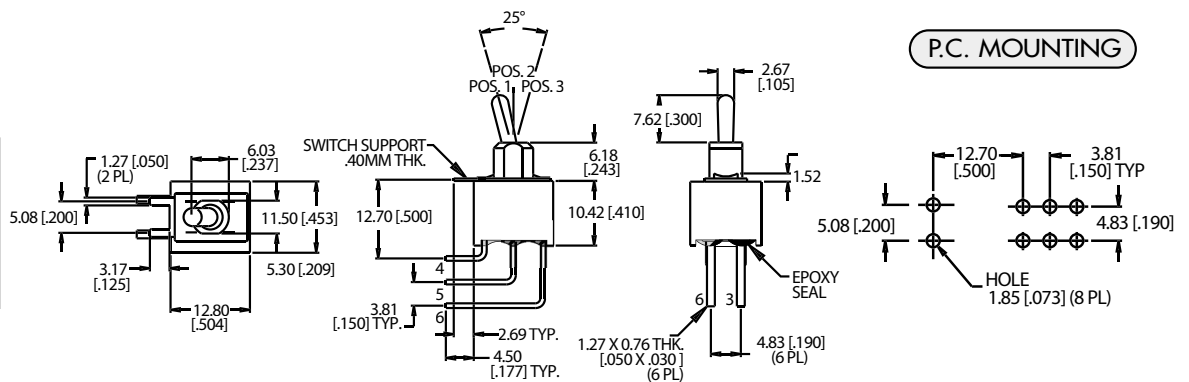

SPECIFICATIONS SUBJECT TO CHANGE WITHOUT NOTICE.

# SERIES 100A SWITCHES

## PROCESS SEALED MINIATURE TOGGLE SWITCHES



**VS2-VS3**

**SPDT**

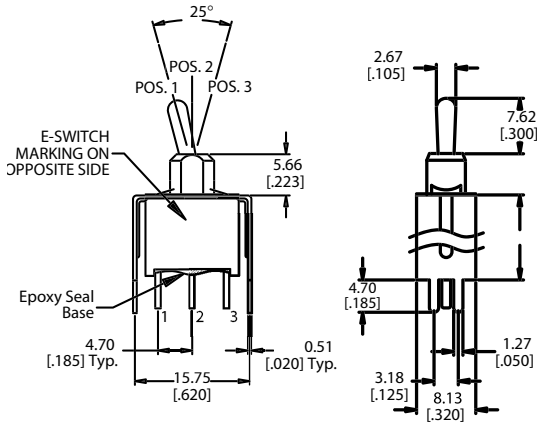

OPTION CODE	DIM. 'A'
VS2	.460 (11.68)
VS3	.630 (16.00)

P.C. MOUNTING

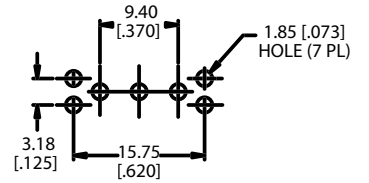

**VS2-VS3**

**DPDT**

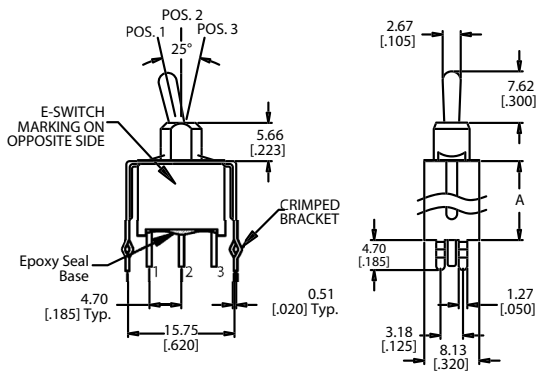

OPTION CODE	DIM. 'A'
VS2	.460 (11.68)
VS3	.630 (16.00)

P.C. MOUNTING

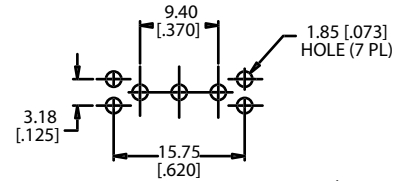

### CONTACT MATERIAL OPTIONS

**Q**

**Fixed Terminal:** Gold flash over silver plated copper alloy

**Moving Contact:** Silver plated copper alloy

**Rating:** 5 Amps with resistive load @ 120VAC or 28VDC;  
2 Amps with resistive load @ 250VAC

**R**

**Fixed Terminal:** Copper alloy with gold plate over nickel plate

**Moving Contact:** Copper alloy with gold plate over nickel plate

**Rating:** 0.4 Volt-Amps (VA) max. @ 20V max. (AC or DC)

### HARDWARE

**HDW2 Nut**

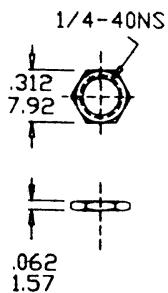

**HDW15 Locking Ring**

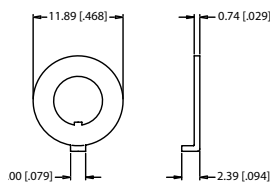

**HDW11 Lock Washer**

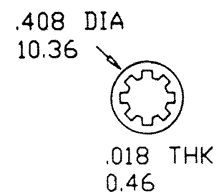

SPECIFICATIONS SUBJECT TO CHANGE WITHOUT NOTICE.