

FEATURES

- -55°C to +85°C operation
- 19 to 36 VDC input or
16 to 36 VDC input typical
- Fully isolated
- Magnetic feedback
- Fixed frequency, 375 kHz typical
- Topology – Single Ended Forward
- 50 V for 50 ms transient protection
- Inhibit function
- Output trim
- Indefinite short circuit protection
- Radiation hardened to
 - 10¹³ neutrons/sq cm neutron fluence
 - 10¹¹ rads(Si)/sec dose rate
 - 10⁵ rads(Si) total dose
- Meets MIL-STD-704E emergency operation and transient standards

DC/DC CONVERTERS 28 VOLT INPUT

MRH SERIES 15 WATT



MODELS		
VDC OUTPUT		
SINGLE	DUAL	TRIPLE
5	±12	+5 & ±12
12	±15	+5 & ±15
15		

Size (max.): Non-flanged, case F3

1.950 x 1.350 x 0.455 inches (49.53 x 34.29 x 11.56 mm)

Flanged, case J3

2.720 x 1.350 x 0.455 inches (69.09 x 34.29 x 11.56 mm)

See Section B8, cases F3 and J3, for dimensions.

Weight: 50 grams typical

Screening: Standard or ES. See Section C2 for screening options and Section A5 for ordering information.

DESCRIPTION

The MRH Series™ of DC/DC converters offers up to 15 watts of power in a radiation hardened design. The low profile MRH converters are manufactured in Interpoint's fully certified and qualified MIL-STD-1772 production facility and packaged in hermetically sealed steel cases. They are ideal for use in programs requiring high reliability, small size, and high levels of radiation hardening.

The MRH converters are switching regulators which use a quasi-square wave, single ended forward converter design with a nominal switching frequency of 375 kHz, typical. Close regulation (main output line regulation is 0.05%) is maintained with advanced constant frequency pulse width modulation design techniques. With a 16 to 36 VDC input range and triple outputs of +5 VDC and either ±12 or ±15 VDC, MRH converters are suitable for a wide range of airborne, naval, and ground based applications. The MRH's feed-forward compensation topology provides high levels (50 dB nominal) of input-to-output ripple rejection.

The MRH converters provide full power operation from -55°C to +85°C with derated operation to +125°C. Flanged and non-flanged package configurations are available with optional environmental screening.

INHIBIT FUNCTION

The MRH Series incorporates an inhibit terminal that can be used to disable internal switching. The converter is inhibited when a logic low (≤ 0.8 V) signal is applied to the TTL open collector compatible inhibit pin. In the inhibit mode the inhibit pin current requirement is less than -2 mA. The converter resumes normal operation when a logic high (≥ 2.4 V) signal or open circuit is applied to the inhibit pin. The open circuit voltage of the inhibit is 5 to 6 volts.

OUTPUT VOLTAGE TRIM

The output voltage on single output models can be trimmed upward by as much as 5% of nominal by connecting a resistor between pin 3 and 4.

RADIATION HARDENED

The MRH DC/DC converters are designed to provide continuous normal operation through radiation levels associated with proximity to thermonuclear events. The converters will operate normally in environments with up to 10¹³ neutrons per square centimeter neutron fluence, 10¹¹ rads (Si) per second dose rate, and 10⁵ rads (Si) total dose. These levels of radiation tolerance make the MRH converters suitable for electronics in tactical programs where operation in high radiation environments is required.

At the highest dose rating (10¹¹ rads (Si)/sec dose rate) there will be an upset resulting in a dip in the voltage. This is non-destructive to the unit. The converter will operate through the upset.

CRANE

interpoint

A CRANE CO. COMPANY

MRH SERIES 15 WATT

DC/DC CONVERTERS

ABSOLUTE MAXIMUM RATINGS	
Power Dissipation (Pd)	• 5 W
Output Power	• 15 watts
Lead Soldering Temperature (10 sec per lead)	• 300°C
Storage Temperature Range (Case)	• -65°C to +125°C

INHIBIT	
Inhibit TTL Open Collector	• Logic low (output disabled) Inhibit pin current ≤ -2 mA
	• Referenced to input common
	• Logic high (output enabled) Open collector

TYPICAL CHARACTERISTICS	
Output Voltage Temperature Coefficient	• 250 ppm/°C max
Input to Output Capacitance	• 100 p, typical
Current Limit	• 125% of full load typical
Isolation	• 100 megohm minimum at 500 V
Conversion Frequency	• 375 kHz, typical
Inhibit Pin Voltage (unit enabled)	• 5 to 6 V
Radiation (will operate through)	• Neutron fluence 10^{13} neutrons/ sq. cm. • Radiation dose rate 10^{11} rads (Si) /sec • Total dose 10^5 rads (Si)

RECOMMENDED OPERATING CONDITIONS	
Input Voltage Range	• Continuous 16 to 40 VDC MRH28XXS and MRH2812D 19 to 40 VDC MRH2815D 16 to 36 VDC MRH285XXT
	• 50 V for 50 msec transient
Case Operating Temperature (Tc)	• -55°C to +85°C full power • -55°C to +125°C absolute

DERATING OUTPUT POWER/CURRENT AND INPUT VOLTAGE	
Temperatures are referenced to the temperature at the converter's baseplate	
• Linearly derate output power/current from 100% at 85°C to 0% at 125°C.	
• Above 105°C linearly derate steady state input voltage to 33 V and transient voltage to 38 V, at 125°C.	
• Operation below an input voltage of 19 volts, including operation in MIL-STD-704E emergency power conditions, is possible with derated output power. See Figures 9 and 10.	

Electrical Characteristics: 25°C Tc, 28 VDC Vin, 100% load, unless otherwise specified.

SINGLE OUTPUT MODELS		MRH2805S			MRH2812S			MRH2815S			UNITS
PARAMETER	CONDITIONS	MIN	TYP	MAX	MIN	TYP	MAX	MIN	TYP	MAX	
OUTPUT VOLTAGE		4.95	5.0	5.05	11.88	12	12.12	14.85	15	15.15	VDC
OUTPUT CURRENT	-55°C TO +85°C	0.05	—	3.0	0.02	—	1.25	0.016	—	1.0	A
OUTPUT POWER	MIN. TO MAX. VIN	0.25	—	15	0.25	—	15	0.25	—	15	W
OUTPUT RIPPLE	10 kHz TO 2 MHz	—	40	70	—	25	50	—	25	50	mV p-p
LINE REGULATION	16 TO 40 VIN	—	5	10	—	5	20	—	5	20	mV
LOAD REGULATION ¹	MIN. LOAD TO FULL	—	5	30	—	5	30	—	5	30	mV
INPUT VOLTAGE ²	NO LOAD TO FULL	16	28	40	16	28	40	19	28	40	VDC
	TRANSIENT 50 ms	—	—	50	—	—	50	—	—	50	V
INPUT CURRENT	NO LOAD	—	50	60	—	50	60	—	50	60	mA
	FULL LOAD	—	—	750	—	—	730	—	—	720	
	INHIBITED	—	22	25	—	22	25	—	22	25	
INPUT RIPPLE CURRENT	10 kHz TO 10 MHz	—	25	50	—	25	50	—	25	50	mA p-p
EFFICIENCY		73	75	—	76	78	—	78	80	—	%
LOAD FAULT ³	SHORT CIRCUIT	—	5	—	—	5	—	—	5	—	W
POWER DISSIPATION	OVERLOAD	—	5	—	—	5	—	—	5	—	W
START-UP	DELAY	—	3	10	—	3	10	—	3	10	ms

Notes

1. Load regulation is not guaranteed below minimum load.
2. Converter should not be inhibited or operated below 12 Vin above 10^4 rads (Si) total dose.

3. Indefinite short circuit protection is not guaranteed above 85°C case.

DC/DC CONVERTERS

MRH SERIES 15 WATT

Electrical Characteristics: 25°C Tc, 28 VDC Vin, 100% load, unless otherwise specified.

DUAL AND TRIPLE OUTPUT MODELS		MRH2812D			MRH2815D			MRH2812T			MRH2815T			UNITS
PARAMETER	CONDITION	MIN	TYP	MAX	MIN	TYP	MAX	MIN	TYP	MAX	MIN	TYP	MAX	
OUTPUT VOLTAGE	MAIN	+11.88	+12.0	+12.12	+14.85	+15.0	+15.15	+4.95	+5.0	+5.05	+4.95	+5.0	+5.05	VDC
	AUX.	-11.82	-12.0	-12.18	-14.77	-15.0	-15.23	±11.50	±12.0	±12.50	±14.40	±15.0	±15.60	
OUTPUT CURRENT ¹ -55°C TO +85°C	MAIN	+0.01	+0.625	+1.0	+0.008	+0.50	+0.8	+0.40	+1.80	+2.00	+0.40	+1.80	+2.00	A
	AUX.	-0.01	-0.625	-1.0	-0.008	-0.50	-0.8	±0.00	±0.25	±0.50	±0.00	±0.20	±0.40	
OUTPUT POWER ¹	MAIN	—	7.5	12	—	7.5	12	2	9	10	2	9	10	W
	AUX.	—	7.5	12	—	7.5	12	0	3	6	0	3	6	
	TOTAL	0.25	—	15	0.25	—	15	2	—	15	2	—	15	
OUTPUT RIPPLE VOLTAGE, 10 kHz - 2 MHz	MAIN	—	40	60	—	40	60	—	50	75	—	30	50	mV p-p
	AUX.	—	40	60	—	40	60	—	30	50	—	30	50	
LINE REGULATION VIN = MIN. TO MAX.	MAIN	—	5	20	—	5	20	—	5	10	—	5	10	mV
	AUX.	—	20	100	—	20	100	—	200	400	—	250	500	
LOAD REGULATION ² NO LOAD TO FULL	MAIN	—	5	30	—	5	30	—	5	10	—	5	10	mV
	AUX.	—	10	100	—	10	100	—	200	400	—	250	500	
INPUT VOLTAGE ³	CONTINUOUS	16	28	40	19	28	40	16	28	36	16	28	36	VDC
	TRANSIENT 50 ms	—	—	50	—	—	50	—	—	40	—	—	40	
INPUT CURRENT	NO LOAD	—	55	70	—	55	70	—	70	80	—	85	95	mA
	FULL LOAD	—	—	700	—	—	700	—	—	770	—	—	778	
	INHIBITED	—	22	25	—	22	25	—	23	25	—	23	25	
INPUT RIPPLE CURRENT	10 kHz TO 2 MHz	—	25	50	—	25	50	—	25	50	—	25	50	mA p-p
EFFICIENCY		76	78	—	76	78	—	70	72	—	70	72	—	%
LOAD FAULT ⁴ POWER DISSIPATION	SHORT CIRCUIT OVERLOAD	—	5	—	—	5	—	—	5	—	—	5	—	W
START-UP DELAY		—	3	10	—	3	10	—	3	10	—	3	10	ms

Notes

- Maximum combined output power is 15 watts for both dual and triple models.
Dual output models: The maximum specification is the total output current/power.
Up to 80% of that total is available from either output provided the positive output maintains a minimum of 20% of the total power used.
Triple output models: The maximum combined power of the auxiliaries is 6 watts, of which 100% is available from either output.
- Load regulation is not guaranteed below minimum load.
- Converter should not be inhibited or operated below 12 Vin above 10⁴ rads (Si) total dose.
- Indefinite short circuit protection is not guaranteed above 85°C case.

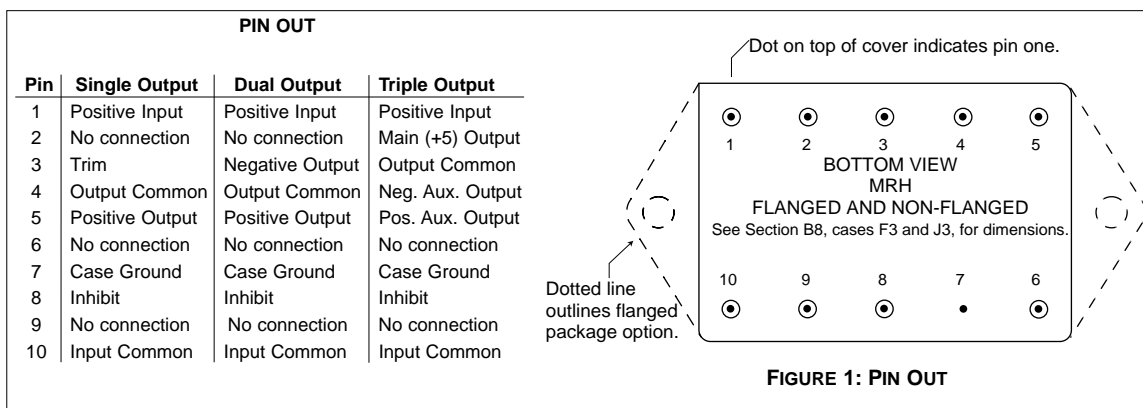
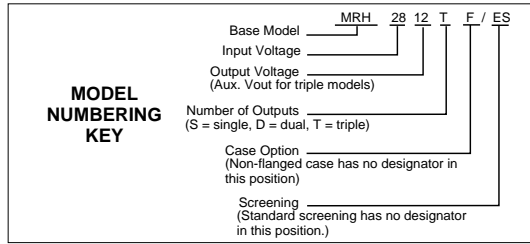

FIGURE 1: PIN OUT

MRH SERIES 15 WATT

DC/DC CONVERTERS



Typical Performance Curves: 25°C Tc, 28 VDC Vin, 100% load, unless otherwise specified.

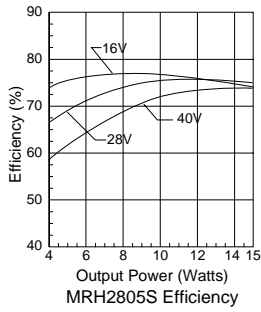

FIGURE 2

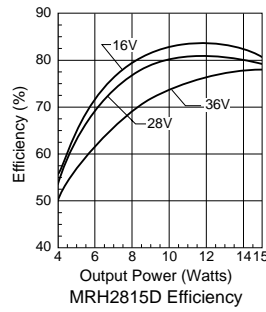

FIGURE 3

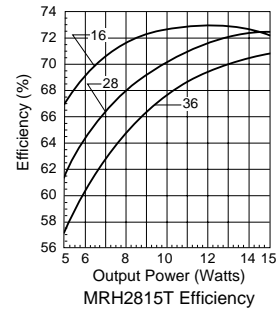

FIGURE 4

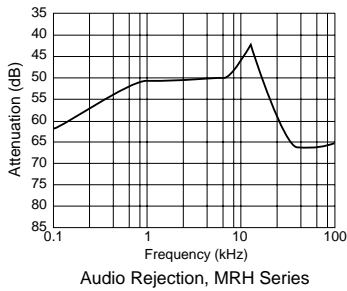

FIGURE 5

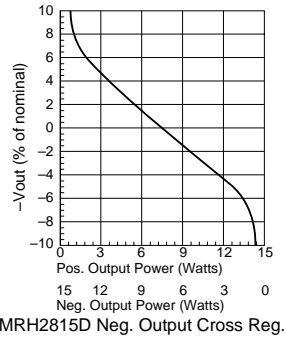

FIGURE 6

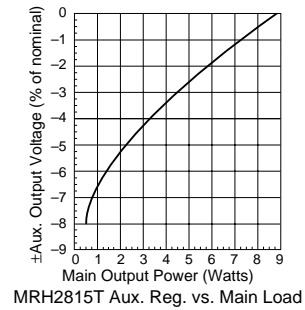

FIGURE 7

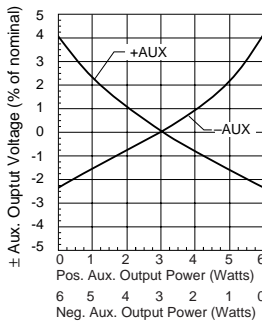

FIGURE 8

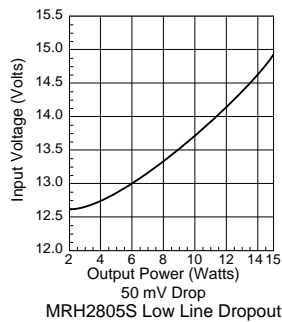

FIGURE 9

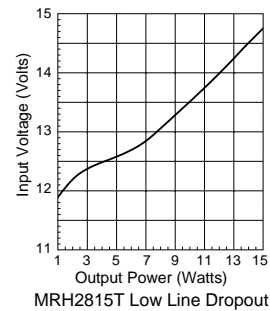
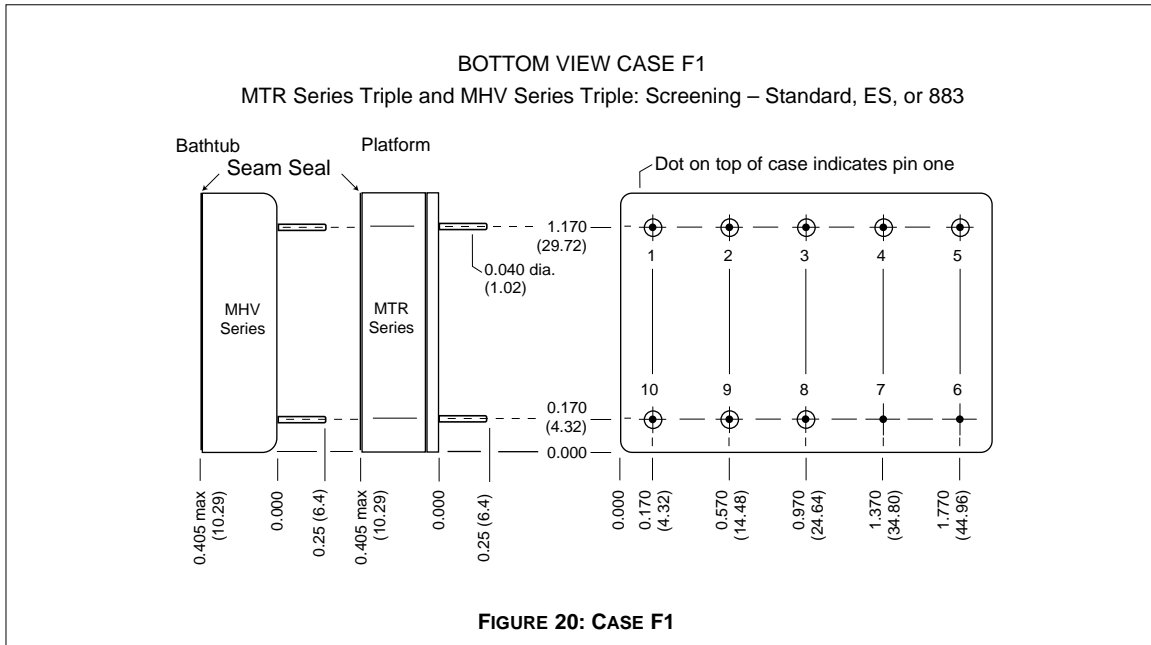
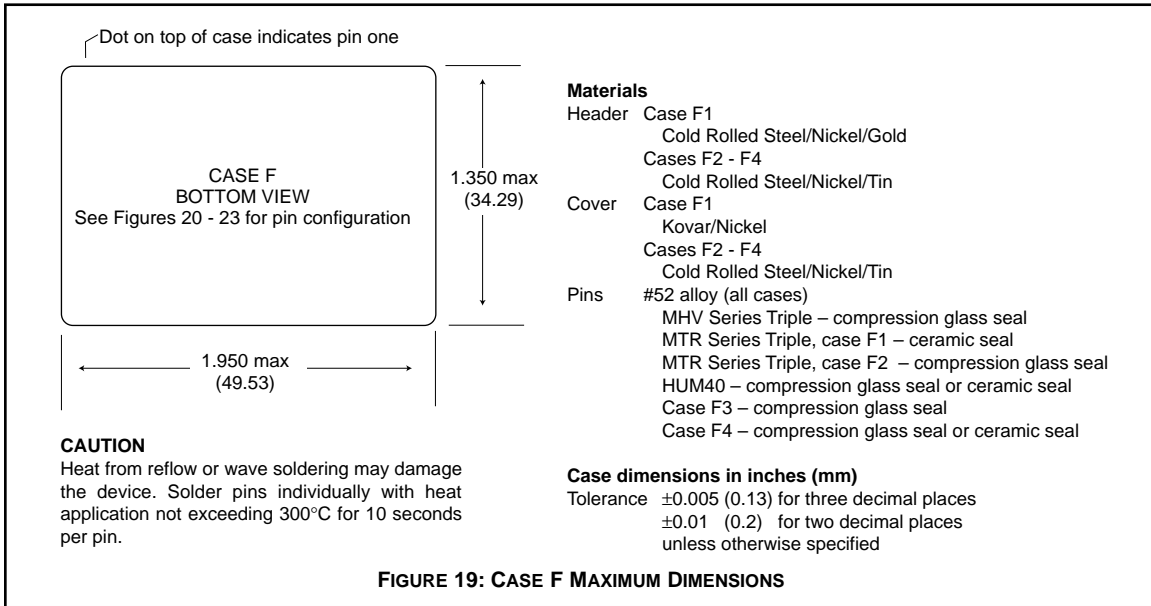

FIGURE 10

23821-001-DTS Rev A DQ# 1020
All technical information is believed to be accurate, but no responsibility is assumed for errors or omissions. Interpoint reserves the right to make changes in products or specifications without notice. MRH Series is a trademark of Interpoint. Copyright © 1994 - 1999 Interpoint. All rights reserved.

CASE F

CASES



Note: Although every effort has been made to render the case drawings at actual size, variations in the printing process may cause some distortion. Please refer to the numerical dimensions for accuracy.

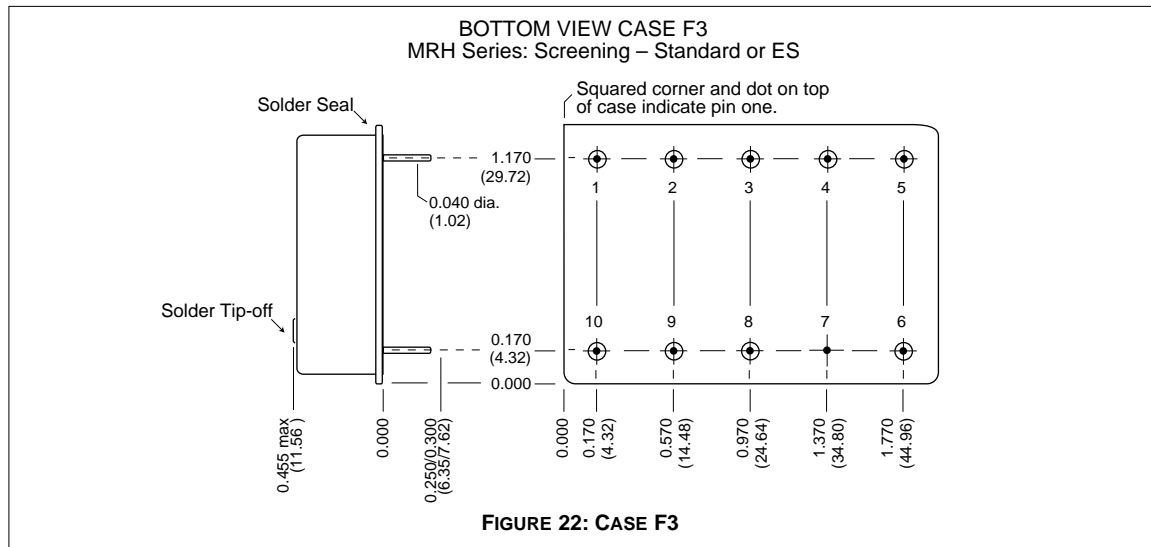
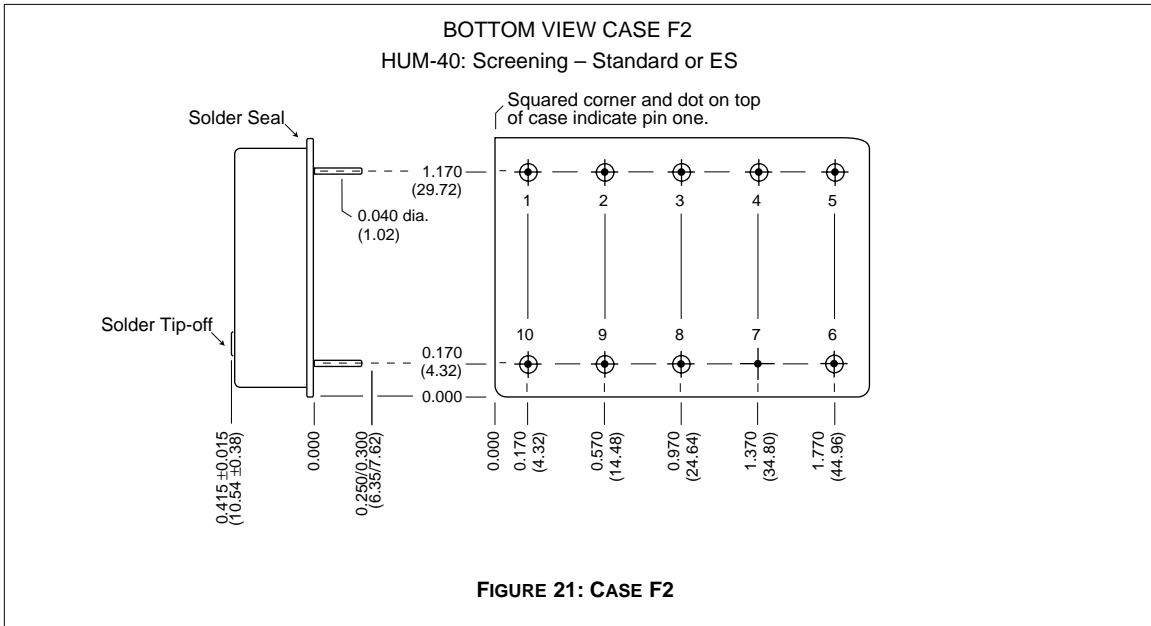

CASE J

CASES

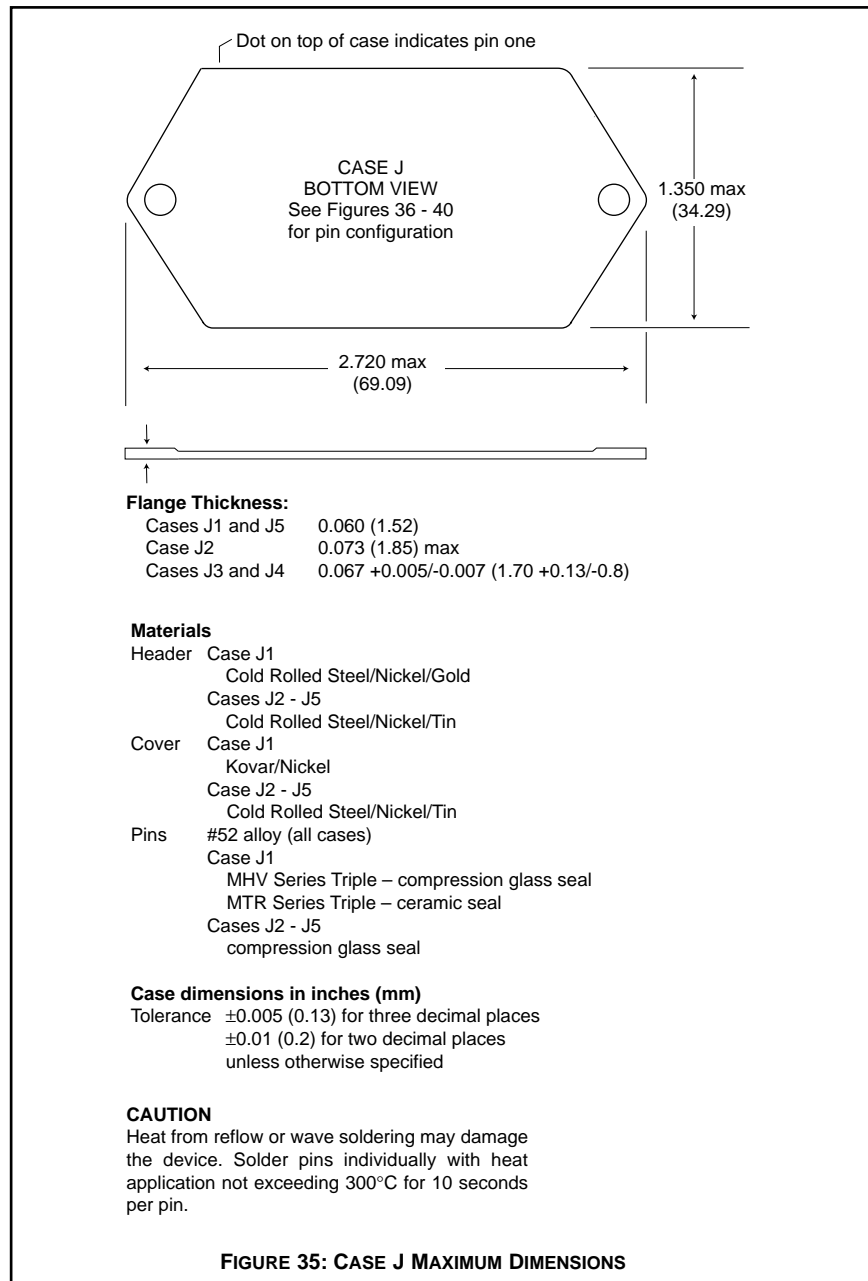

Note: Although every effort has been made to render the case drawings at actual size, variations in the printing process may cause some distortion. Please refer to the numerical dimensions for accuracy.

CASE J

CASES

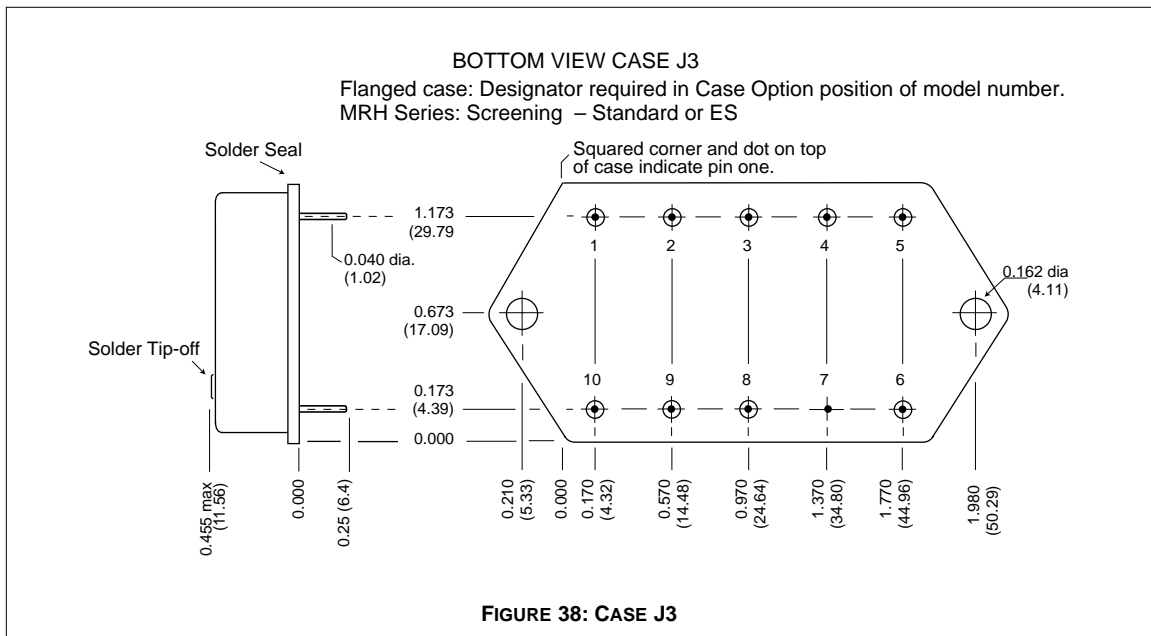
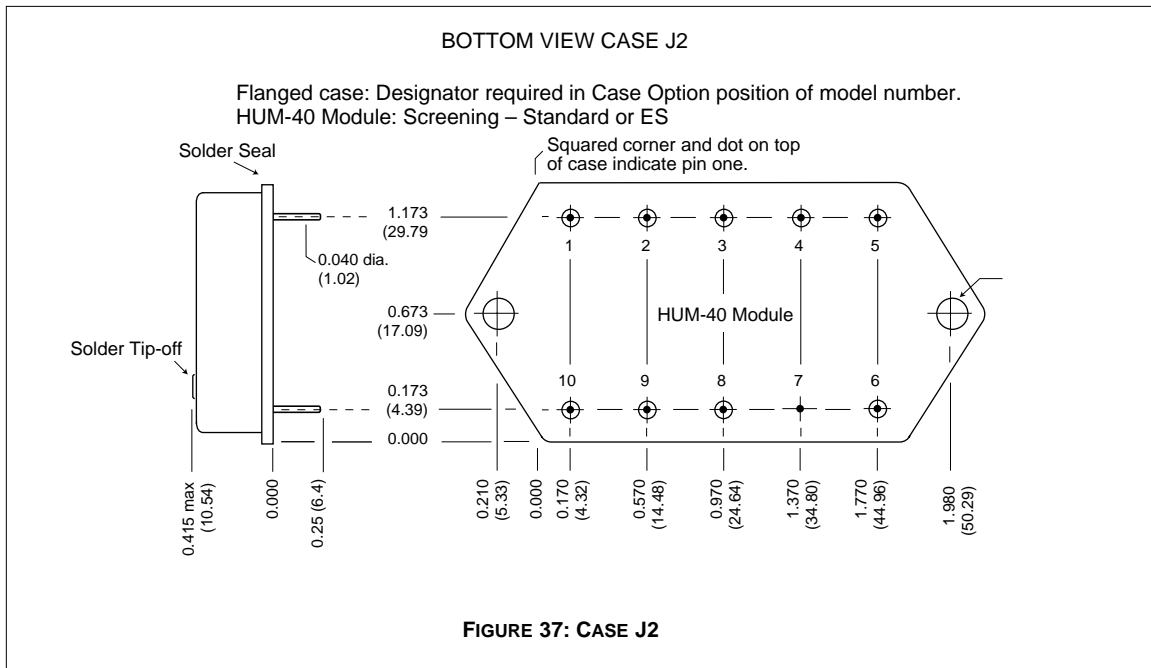

**QA SCREENING
85°C PRODUCTS**

85°C PRODUCTS

TEST (85°C Products excluding HR products)	STANDARD	/ES
PRE-CAP INSPECTION Method 2017	yes	yes
TEMPERATURE CYCLE (10 times) Method 1010, Cond. B, -55°C to 125°C	no	yes
CONSTANT ACCELERATION Method 2001, 500 g	no	yes
BURN-IN 96 hours at 70°C ambient (typical)	no	yes
FINAL ELECTRICAL TEST MIL-PRF-38534, Group A Subgroups 1 and 4: +25°C case	yes	yes
HERMETICITY TESTING Fine Leak, Method 1014, Cond. A Gross Leak, Method 1014, Cond. C Gross Leak, Dip (1 x 10 ⁻³)	no no yes	yes yes no
FINAL VISUAL INSPECTION Method 2009	yes	yes

Test methods are referenced to MIL-STD-883 as determined by MIL-PRF-38534.

Applies to the following products:

- MFW Series
- MTW Series
- MHE/MLP Series
- MHL Series
- MRH Series
- MTO Series
- MSR Series
- DCH Series
- FM/FMA/FMB EMI Filters
- MSF EMI Filter