

# LAS 1500, 15U, 15A00, SERIES

## 1.5 AMP POSITIVE REGULATORS

### DESCRIPTION

The LAS-1500 series voltage regulators are monolithic integrated circuits designed for use in applications requiring a well regulated positive output voltage. Outstanding features include full power usage up to 1.5 amperes of load current, internal current limiting, thermal shutdown, and safe area protection on the chip, providing protection of the series pass darlington, under most operating conditions. Hermetically sealed steel TO-3 packages are utilized for high reliability and low thermal resistance when used with an appropriate heat sink. A low-noise temperature stable diode reference is the key design factor insuring excellent temperature regulation of the LAS-1500 series. This coupled to a very low output impedance insures superior performance and load regulation.

The LAS-1500 series of three-terminal regulators are available in fixed output voltage tolerances of  $\pm 5\%$  with nominal output voltages ranging from +5 to +28 volts. The LAS-15A00 three-terminal regulators are available in fixed output voltage tolerances of  $\pm 2\%$  with nominal output voltages available of +5, +12, and +15 volts. The LAS-15U, a four-terminal adjustable regulator, is available with an output range from +4 to +30 volts, adjustable with a single potentiometer.

### ABSOLUTE MAXIMUM RATINGS

PARAMETER	SYMBOL	MINIMUM	MAXIMUM	UNITS
INPUT VOLTAGE	$V_{IN}$	0	35 (40) <sup>(1)</sup>	VOLTS
INPUT/OUTPUT DIFFERENTIAL	$V_{IN}-V_{OUT}$	0	30 <sup>(1)</sup>	VOLTS
POWER DISSIPATION @ $T_C \leq 105^\circ\text{C}$	$P_D$		15 <sup>(1,2)</sup>	WATTS
THERMAL RESISTANCE JUNCTION TO CASE	$\theta_{JC}$		3	$^\circ\text{C}/\text{WATT}$
OPERATING JUNCTION TEMPERATURE RANGE	$T_J$	-55	150	$^\circ\text{C}$
STORAGE TEMPERATURE RANGE	$T_{STG}$	-5E	150	$^\circ\text{C}$
LEAD TEMPERATURE (SOLDERING, 60 SECONDS TIME LIMIT)	$T_{LEAD}$		300	$^\circ\text{C}$

- (1) The maximum input voltage of the LAS-1500 Series is limited by the maximum input-output differential, maximum power dissipation, or the maximum current limit-safe operating area, whichever is less. Values of 35 volts apply to  $V_O$  of +4V to +12V. Values of +40V apply to  $V_O$  of 13.8V to +28V.
- (2) For operation above  $105^\circ\text{C}$   $T_{CASE}$ , derate @ 333 mW/ $^\circ\text{C}$ .

### REGULATOR PERFORMANCE SPECIFICATIONS

INPUT VOLTAGE TEST CONDITIONS ARE AS FOLLOWS:  $V_1 = V_O + 5$  VOLTS,  $V_2 = V_O + 15$  VOLTS,  $V_3 = V_O + 20$  VOLTS, OR THE MAXIMUM INPUT WHICHEVER IS LESS.

PARAMETER	SYMBOL	TEST CONDITIONS			LAS 1500 TEST LIMITS		LAS 15U TEST LIMITS		UNITS	
		$V_{IN}$	$I_O$	$T_J$	MIN	MAX	MIN	MAX		
Input Voltage	$V_{IN}$		5mA	0-125 $^\circ\text{C}$	$V_O + 2.4$	(s)	$V_O + 2.4$	(s)	volts	
Output Voltage	$V_O$	$V_1$ to $V_2$	10mA to 1.0A	25 $^\circ\text{C}$	$0.95 V_O ^{(1)}$	$1.05V_O$	$4.0^{\circ}$	30	volts	
Input-Output Differential	$V_{IN}-V_O$		1.0A	0-125 $^\circ\text{C}$	2.4		2.4		volts	
Output Current	$I_O$	$V_1$		25 $^\circ\text{C}$	0	1.5	0	1.5	amps	
Line Regulation <sup>(2)</sup>	REG(LINE)	$V_1$ to $V_3$	0.1A	25 $^\circ\text{C}$		1.0		1.0	% $V_O$	
		$V_1$ to $V_3$	0.5A	25 $^\circ\text{C}$		2.0		2.0	% $V_O$	
		$V_1$ to $V_2$	1.0A	25 $^\circ\text{C}$		2.0		2.0	% $V_O$	
Load Regulation <sup>(2)</sup>	REG(LOAD)	$V_1$	5mA to 1.5A	25 $^\circ\text{C}$		0.6		0.6	% $V_O$	
Quiescent Current	$I_Q$	$V_1$	Output/Open	25 $^\circ\text{C}$		10		10	mA	
Quiescent Current Line	$I_{Q(LINE)}$	$V_1$ to $V_3$	5mA	25 $^\circ\text{C}$		1.3		1.3	mA	
Quiescent Current Load	$I_{Q(LOAD)}$	$V_1$	5mA to 1.5A	25 $^\circ\text{C}$		0.75		0.75	mA	
Current Limit	$I_{LIM}$	$V_1$		25 $^\circ\text{C}$		3.5		3.5	amps	
Short Circuit Current	$I_S$	$V_1$		25 $^\circ\text{C}$		3.5		3.5	amps	
Temperature Coefficient	$T_C$	$V_1$	0.1A	0-125 $^\circ\text{C}$		0.03		0.03	% $V_O/^\circ\text{C}$	
Output Noise Voltage	$V_N$	$V_1$	0.1A	0-125 $^\circ\text{C}$		$10^{(3)}$		$10^{(3)}$	$\mu\text{Vrms}/\text{V}$	
Ripple Attenuation	RA	$V_1$	1.0A	0-125 $^\circ\text{C}$		58 <sup>(4)</sup>		58 <sup>(4)</sup>	dB	
Control Voltage	VC	$V_1$ to $V_2$	5mA	25 $^\circ\text{C}$				3.5	4.0	volts

- (1) Nominal output voltages are specified under ordering information.
- (2) Instantaneous regulation, average chip temperature changes must be accounted for separately.
- (3) BW = 10 HZ — 100 KHz.
- (4) Ripple attenuation is specified for a 1 Vrms, 120 Hz input ripple. Ripple attenuation is a minimum of 58 dB at a 5 volt output, and is 1 dB less for each volt increase in the output voltage.
- (5) The maximum input voltage of the LAS-1500 series is limited by maximum input-output differential voltage, maximum power dissipation, or the current limit-SOA, whichever is less.
- (6)  $V_O = V_C (1 + \frac{R1}{R2})$  R1 = Resistance from output to control.  
R2 = Resistance from control to common.

Continued on next page

# LAS 1500, 15U, 15A00, SERIES

## 1.5 AMP POSITIVE REGULATORS

### REGULATOR PERFORMANCE SPECIFICATIONS

INPUT VOLTAGE TEST CONDITIONS ARE AS FOLLOWS:  $V_1 = V_o + 5$  VOLTS,  $V_2 = V_o + 15$  VOLTS,  $V_3 = V_o + 20$  VOLTS, OR THE MAXIMUM INPUT WHICHEVER IS LESS.

PARAMETER	SYMBOL	TEST CONDITIONS			LAS 15A00 TEST LIMITS		UNITS
		$V_{IN}$	$I_o$	$T_J$	MIN	MAX	
Input Voltage	$V_{IN}$	5mA	0-125°C	$V_o + 2.4$ (5)			volts
Output Voltage	$V_o$	$V_1$ to $V_2$	10mA to 1.0A	25°C	$0.98 V_o $ (1)	$1.02 V_o$	volts
Input-Output Differential	$V_{IN}-V_o$		1.0A	0-125°C	2.4		volts
Output Current	$I_o$	$V_1$		25°C	0	1.5	amps
Line Regulation (2)	REG(LINE)	$V_1$ to $V_3$	0.1A	25°C		1.0	% $V_o$
		$V_1$ to $V_3$	0.5A	25°C		1.0	% $V_o$
		$V_1$ to $V_2$	1.0A	25°C		1.0	% $V_o$
Load Regulation (2)	REG(LOAD)	$V_1$	5mA to 1.5A	25°C		0.6	% $V_o$
Quiescent Current	$I_Q$	$V_1$	Output/Open	25°C		10	mA
Quiescent Current Line	$I_Q$ (LINE)	$V_1$ to $V_3$	5mA	25°C		1.3	mA
Quiescent Current Load	$I_Q$ (LOAD)	$V_1$	5mA to 1.5A	25°C		0.75	mA
Current Limit	$I_{LIM}$	$V_1$		25°C		3.5	amps
Short Circuit Current	$I_S$	$V_1$		25°C		3.5	amps
Temperature Coefficient	$T_C$	$V_1$	0.1A	0-125°C		0.03	% $V_o/°C$
Output Noise Voltage	$V_N$	$V_1$	0.1A	0-125°C		$10^{(3)}$	$\mu V_{rms}/V$
Ripple Attenuation	RA	$V_1$	1.0A	0-125°C		$58^{(4)}$	dB

- (1) Nominal output voltages are specified under ordering information.
- (2) Instantaneous regulation, average chip temperature changes must be accounted for separately.
- (3) BW = 10 Hz — 100 KHz.
- (4) Ripple attenuation is specified for a 1 Vrms, 120 Hz input ripple. Ripple attenuation is a minimum of 58 dB at a 5 volt output, and is 1 dB less for each volt increase in the output voltage.
- (5) The maximum input voltage of the LAS-15A00 series is limited by maximum input-output differential voltage, maximum power dissipation, or the current limiting-SOA, whichever is less.

## OUTLINE DRAWING

TO-3 3-TERMINAL (STEEL)

TO-3 4-TERMINAL (STEEL)

LAS-1500  
LAS-15A00

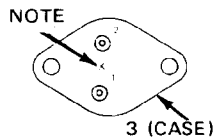
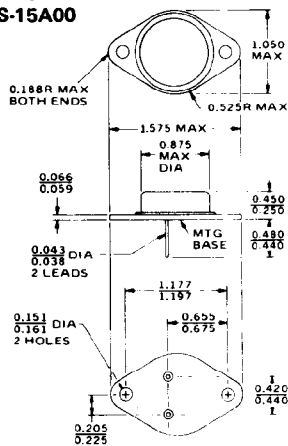

PIN	FUNCTION
1	INPUT
2	OUTPUT
3	COMMON

NOTE (X) = CASE TEMPERATURE MEASURED AT THIS POINT.

LAS-15U

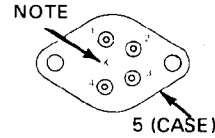
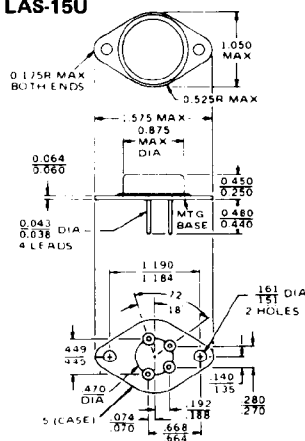

PIN	FUNCTION
1	COMMON (ELEC)
2	CONTROL
3	OUTPUT
4	INPUT
5	COMMON

NOTE (X) = CASE TEMPERATURE MEASURED AT THIS POINT.

# LAS 1500, 15U, 15A00, SERIES

## 1.5 AMP POSITIVE REGULATORS OPERATIONAL DATA

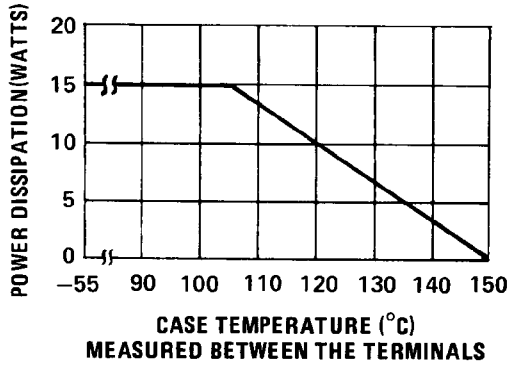

POWER DERATING

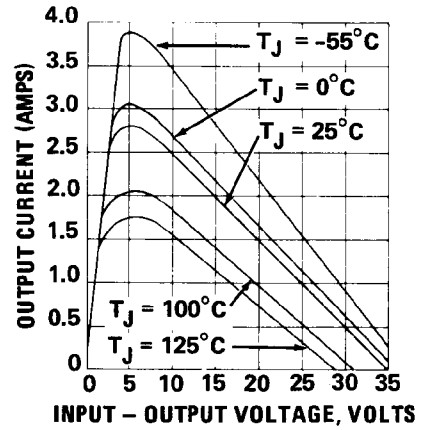

TYPICAL CURRENT LIMIT VS INPUT-OUTPUT VOLT. DIFF.

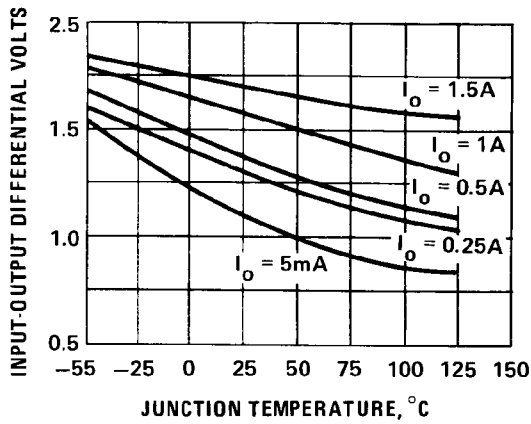

TYPICAL MINIMUM INPUT-OUTPUT DIFFERENTIAL VOLTAGE VS JUNCTION TEMPERATURE

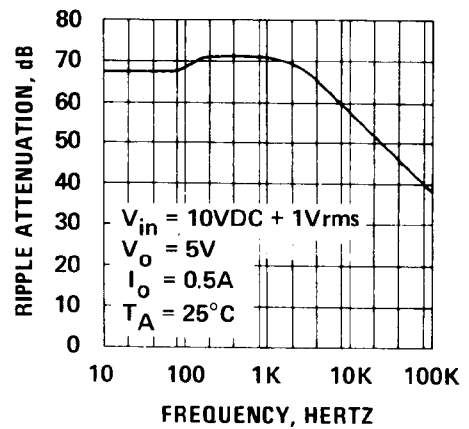

TYPICAL RIPPLE ATTENUATION VS FREQUENCY

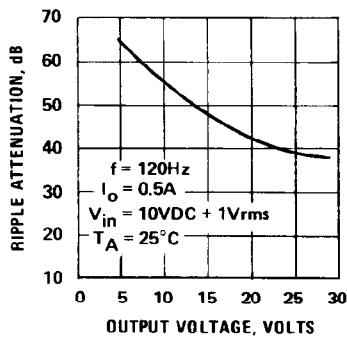

TYPICAL RIPPLE ATTENUATION VS OUTPUT VOLTAGE

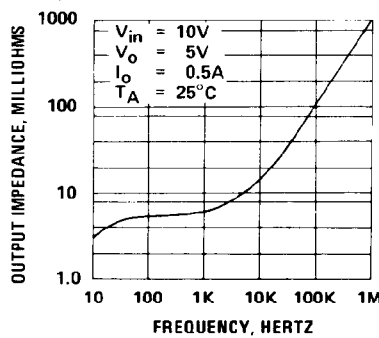

TYPICAL OUTPUT IMPEDANCE VS FREQUENCY

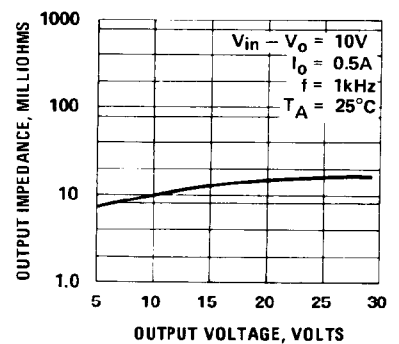

TYPICAL OUTPUT IMPEDANCE VS OUTPUT VOLTAGE