

FEATURES

- Correlated Double Sampler (CDS)
- 6 dB to 40 dB Variable Gain Amplifier (VGA)
- Black Level Clamp with Variable Level Control
- Complete On-Chip Timing Generator
- Precision Timing Core with 1 ns Resolution
- On-Chip: 2-Channel Horizontal and 1-Channel RG Drivers
- 2-Phase H-Clock Modes
- 4-Phase Vertical Transfer Clocks
- Electronic and Mechanical Shutter Modes
- On-Chip Sync Generator with External Sync Option
- Space Saving 48-Lead LFCSP Package

APPLICATIONS

- Digital Still Cameras
- Digital Video Camcorders

GENERAL DESCRIPTION

The AD9898 is a highly integrated CCD signal processor for digital still camera and digital video camera applications. It includes a complete analog front end with A/D conversion combined with a full function programmable timing generator. A Precision Timing core allows adjustment of high speed clocks with 1 ns resolution at 20 MHz operation.

The AD9898 is specified at pixel rates as high as 20 MHz. The analog front end includes black level clamping, CDS, VGA, and a 10-bit A/D converter. The timing generator provides all the necessary CCD clocks: RG, H-clocks, V-clocks, sensor gate pulses, substrate clock, and substrate bias pulse. Operation is programmed using a 3-wire serial interface.

Packaged in a space saving 48-Lead LFCSP, the AD9898 is specified over an operating temperature range of -20°C to $+85^{\circ}\text{C}$.

FUNCTIONAL BLOCK DIAGRAM

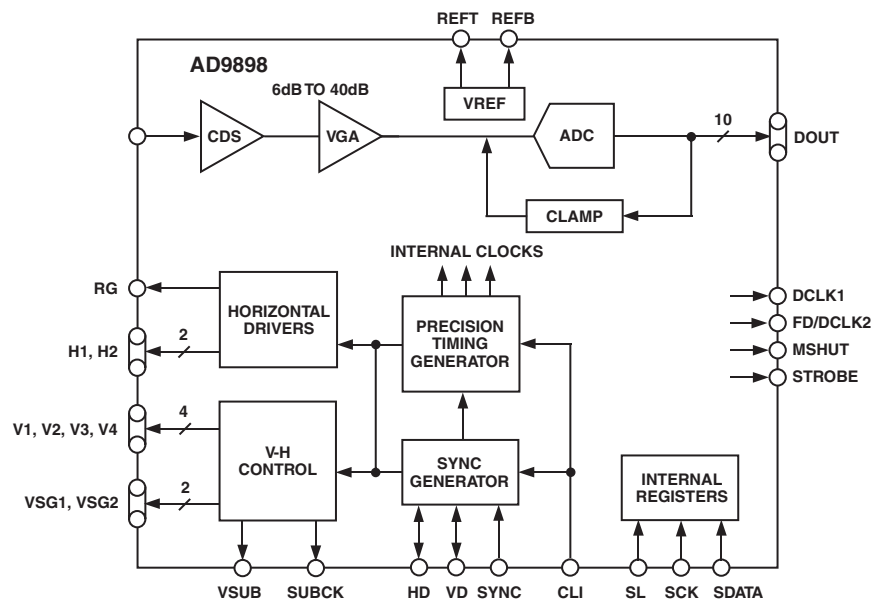

REV. 0

Information furnished by Analog Devices is believed to be accurate and reliable. However, no responsibility is assumed by Analog Devices for its use, nor for any infringements of patents or other rights of third parties that may result from its use. No license is granted by implication or otherwise under any patent or patent rights of Analog Devices. Trademarks and registered trademarks are the property of their respective companies.

SPECIFICATIONS

Parameter	Min	Typ	Max	Unit
TEMPERATURE RANGE				
Operating	-20		+85	°C
Storage	-65		+150	°C
POWER SUPPLY VOLTAGE				
AVDD (AFE Analog Supply)	2.7	3.0	3.6	V
TCVDD (Timing Core Analog Supply)	2.7	3.0	3.6	V
RGVDD (RG Driver)	2.7	3.0	3.6	V
HVDD (H1–H2 Drivers)	2.7	3.0	3.6	V
DRVDD (Data Output Drivers)	2.7	3.0	3.6	V
DVDD (Digital)	2.7	3.0	3.6	V
POWER DISSIPATION				
20 MHz, Typical Supply Levels, 100 pF H1–H2 Loading		150		mW
Power from HVDD Only*		36		mW
Power-Down Mode (AFE and Digital in Standby Operation)		3		mW
MAXIMUM CLOCK RATE (CLI)				
AD9898	20			MHz

*The total power dissipated by the HVDD supply may be approximated using the equation

$$\text{Total HVDD Power} = (\text{CLOAD} \times \text{HVDD} \times \text{Pixel Frequency}) \times \text{HVDD} \times \text{Number of H-Outputs Used}$$

Actual HVDD power may be slightly higher than the calculated value because of stray capacitance inherent in the PCB layout/routing.

Specifications subject to change without notice.

DIGITAL SPECIFICATIONS (RGVDD = HVDD = 2.7 V to 3.6 V, DVDD = DRVDD = 2.7 V to 3.6 V, C_L = 20 pF, T_{MIN} to T_{MAX}, unless otherwise noted.)

Parameter	Symbol	Min	Typ	Max	Unit
LOGIC INPUTS					
High Level Input Voltage	V _{IH}	2.1			V
Low Level Input Voltage	V _{IL}			0.6	V
High Level Input Current	I _{IH}		10		μA
Low Level Input Current	I _{IL}		10		μA
Input Capacitance	C _{IN}		10		pF
LOGIC OUTPUTS (Except H and RG)					
High Level Output Voltage @ I _{OH} = 2 mA	V _{OH}	2.2			V
Low Level Output Voltage @ I _{OL} = 2 mA	V _{OL}			0.5	V
RG and H-DRIVER OUTPUTS (H1–H2)					
High Level Output Voltage @ Maximum Current	V _{OH}	VDD – 0.5			V
Low Level Output Voltage @ Maximum Current	V _{OL}			0.5	V
RG Maximum Output Current (Programmable)				15	mA
H1 and H2 Maximum Output Current (Programmable)				30	mA
Maximum Load Capacitance		100			pF

Specifications subject to change without notice.

AD9898

ANALOG SPECIFICATIONS (AVDD = 3.0 V, f_{CLI} = 20 MHz, T_{MIN} to T_{MAX}, unless otherwise noted.)

Parameter	Min	Typ	Max	Unit	Comments
CDS					
Allowable CCD Reset Transient		500		mV	Input Signal Characteristics
Maximum Input Range before Saturation*	1.0			V p-p	
Maximum CCD Black Pixel Amplitude		±100		mV	
VARIABLE GAIN AMPLIFIER (VGA)					
Maximum Output Range	2.0			V p-p	
Gain Control Resolution		1024		Steps	
Gain Monotonicity		Guaranteed			
Gain Range					
Low Gain		6		dB	
Maximum Gain		40		dB	
BLACK LEVEL CLAMP					
Clamp Level Resolution		64		Steps	LSB is measured at ADC output.
Clamp Level				LSB	
Minimum Clamp Level		0		LSB	
Maximum Clamp Level		63		LSB	
A/D CONVERTER					
Resolution	10			Bits	
Differential Nonlinearity (DNL)		±0.5		LSB	
No Missing Codes		Guaranteed			
Full-Scale Input Voltage		2.0		V	
VOLTAGE REFERENCE					
Reference Top Voltage (REFT)		2.0		V	
Reference Bottom Voltage (REFB)		1.0		V	
SYSTEM PERFORMANCE					
Gain Accuracy					Includes entire signal chain
Low Gain (VGA Code = 20)	5	6	7	dB	Gain = (0.035 × Code) + 5.3 dB
Maximum Gain (VGA Code = 991)	39	40	41	dB	
Peak Nonlinearity, 500 mV Input Signal		0.1		%	12 dB gain applied
Total Output Noise		0.3		LSB rms	AC grounded input, 6 dB gain applied
Power Supply Rejection (PSR)		40		dB	Measured with step change on supply

*Input signal characteristics defined as follows:

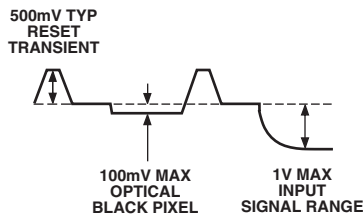

Specifications subject to change without notice.

TIMING SPECIFICATIONS ($C_L = 20$ pF, $AVDD = DVDD = DRVDD = 3.0$ V, $f_{CLI} = 20$ MHz, unless otherwise noted.)

Parameter	Symbol	Min	Typ	Max	Unit
MASTER CLOCK, CLI					
CLI Clock Period	t_{CONV}	50			ns
CLI High/Low Pulsewidth		20	25		ns
Delay from CLI Rising Edge to Internal Pixel Position 0	t_{CLIDLY}		6		ns
AFE CLAMP PULSES*					
CLPOB Pulsewidth		4	10		Pixels
AFE SAMPLE LOCATION* (See Figure 13)					
SHP Sample Edge to SHD Sample Edge	t_{S1}	20	25		Pixels
DATA OUTPUTS (See Figure 15)					
Output Delay from DCLK Rising Edge	t_{OD}		9		ns
Pipeline Delay from SHP/SHD Sampling			9		Cycles
SERIAL INTERFACE (See Figures 7 and 8)					
Maximum SCK Frequency	f_{SCLK}	10			MHz
SL to SCK Setup Time	t_{LS}	10			ns
SCK to SL Hold Time	t_{LH}	10			ns
SDATA Valid to SCK Rising Edge Setup	t_{DS}	10			ns
SCK Falling Edge to SDATA Valid Hold	t_{DH}	10			ns
SCK Falling Edge to SDATA Valid Read	t_{DV}	10			ns

*Parameter is programmable.

Specifications subject to change without notice.

AD9898

ABSOLUTE MAXIMUM RATINGS*

Parameter	With Respect To	Min	Max	Unit
AVDD	AVSS	-0.3	+3.9	V
TCVDD	TCVSS	-0.3	+3.9	V
HVDD	HVSS	-0.3	+3.9	V
RGVDD	RGVSS	-0.3	+3.9	V
DVDD	DVSS	-0.3	+3.9	V
DRVDD	DRVSS	-0.3	+3.9	V
RG Output	RGVSS	-0.3	RGVDD + 0.3	V
H1-H2 Output	HVSS	-0.3	HVDD + 0.3	V
Digital Outputs	DVSS	-0.3	DVDD + 0.3	V
Digital Inputs	DVSS	-0.3	DVDD + 0.3	V
SCK, SL, SDATA	DVSS	-0.3	DVDD + 0.3	V
REFT, REFB	AVSS	-0.3	AVDD + 0.3	V
CCDIN	AVSS	-0.3	AVDD + 0.3	V
Junction Temperature			150	°C
Lead Temperature, 10 sec			300	°C

*Stresses above those listed under Absolute Maximum Ratings may cause permanent damage to the device. This is a stress rating only; functional operation of the device at these or any other conditions above those listed in the operational sections of this specification is not implied. Exposure to absolute maximum rating conditions for extended periods may affect device reliability.

PACKAGE THERMAL CHARACTERISTICS

Thermal Resistance

$$\theta_{JA} = 92^{\circ}\text{C}/\text{W}$$

ORDERING GUIDE

Model	Temperature Range	Package Description	Package Option
AD9898KCP-20	-20°C to +85°C	Lead Frame Chip Scale Package (LFCSP)	CP-48
AD9898KCPRL-20	-20°C to +85°C	Lead Frame Chip Scale Package (LFCSP)	CP-48

CAUTION

ESD (electrostatic discharge) sensitive device. Electrostatic charges as high as 4000 V readily accumulate on the human body and test equipment and can discharge without detection. Although the AD9898 features proprietary ESD protection circuitry, permanent damage may occur on devices subjected to high energy electrostatic discharges. Therefore, proper ESD precautions are recommended to avoid performance degradation or loss of functionality.



PIN CONFIGURATION

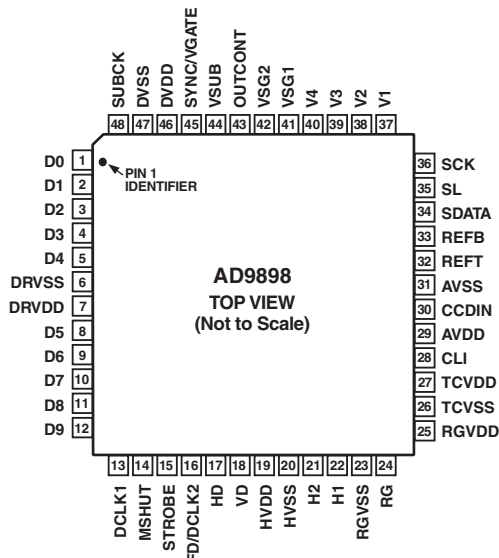

PIN FUNCTION DESCRIPTION

Pin No.	Mnemonic	Type*	Description	Pin No.	Mnemonic	Type*	Description
1	D0	DO	Data Output	28	CLI	DI	Reference Clock Input
2	D1	DO	Data Output	29	AVDD	P	Analog Supply for AFE
3	D2	DO	Data Output	30	CCDIN	AI	CCD Input Signal
4	D3	DO	Data Output	31	AVSS	P	Analog Ground for AFE
5	D4	DO	Data Clock Output	32	REFT	AO	Voltage Reference Top Bypass
6	DRVSS	P	Data Output Driver Ground	33	REFB	AO	Voltage Reference Bottom Bypass
7	DRVDD	P	Data Output Driver Supply	34	SDATA	DI	3-Wire Serial Data Input
8	D5	DO	Data Output	35	SL	DI	3-Wire Serial Load Pulse
9	D6	DO	Data Output	36	SCK	DI	3-Wire Serial Clock
10	D7	DO	Data Output	37	V1	DO	CCD Vertical Transfer Clock 1
11	D8	DO	Data Output	38	V2	DO	CCD Vertical Transfer Clock 2
12	D9	DO	Data Output	39	V3	DO	CCD Vertical Transfer Clock 3
13	DCLK1	DO	Data Clock Output	40	V4	DO	CCD Vertical Transfer Clock 4
14	MSHUT	DO	Mechanical Shutter Pulse	41	VSG1	DO	CCD Sensor Gate Pulse 1
15	STROBE	DO	Strobe Pulse	42	VSG2	DO	CCD Sensor Gate Pulse 2
16	FD/ DCLK2	DO	Field Designator Output DCLK2 Output	43	OUTCONT	DI	Output Control
17	HD	DI	Horizontal Sync Pulse	44	VSUB	DO	CCD Substrate Bias
18	VD	DI	Vertical Sync Pulse	45	SYNC/ VGATE	DI	External System Sync Input VGATE Input
19	HVDD	P	H1–H2 Driver Supply	46	DVDD	P	Digital Supply for VSG, V1–V4, HD, VD, MSHUT, STROBE, and Serial Interface
20	HVSS	P	H1–H2 Driver Ground	47	DVSS	P	Digital Ground
21	H2	DO	CCD Horizontal Clock 2	48	SUBCK	DO	CCD Substrate Clock (E-Shutter)
22	H1	DO	CCD Horizontal Clock 1				
23	RGVSS	P	RG Driver Ground				
24	RG	DO	CCD Reset Gate Clock				
25	RGVDD	P	RG Driver Supply				
26	TCVSS	P	Analog Ground for Timing Core				
27	TCVDD	P	Analog Supply for Timing Core				

*AI = Analog Input, AO = Analog Output, DI = Digital Input, DO = Digital Output, P = Power.

AD9898

SPECIFICATION DEFINITIONS

Differential Nonlinearity (DNL)

An ideal ADC exhibits code transitions that are exactly 1 LSB apart. DNL is the deviation from this ideal value. Thus every code must have a finite width. No missing codes guaranteed to 10-bit resolution indicates that all 1024 codes, respectively, must be present over all operating conditions.

Peak Nonlinearity

Peak nonlinearity, a full signal chain specification, refers to the peak deviation of the output of the AD9898 from a true straight line. The point used as zero scale occurs 1/2 LSB before the first code transition. Positive full scale is defined as a level 1 1/2 LSB beyond the last code transition. The deviation is measured from the middle of each particular output code to the true straight line. The error is then expressed as a percentage of the 2 V ADC full-scale signal. The input signal is always appropriately gained up to fill the ADC's full-scale range.

Total Output Noise

The rms output noise is measured using histogram techniques. The standard deviation of the ADC output codes is calculated in LSB and represents the rms noise level of the total signal chain at the specified gain setting. The output noise can be converted to an equivalent voltage, using the relationship $1 \text{ LSB} = (\text{ADC Full Scale}/2^N \text{ codes})$ where N is the bit resolution of the ADC. For the AD9898, 1 LSB is 2 mV.

Power Supply Rejection (PSR)

The PSR is measured with a step change applied to the supply pins. The PSR specification is calculated from the change in the data outputs for a given step change in the supply voltage.

EQUIVALENT INPUT CIRCUITS

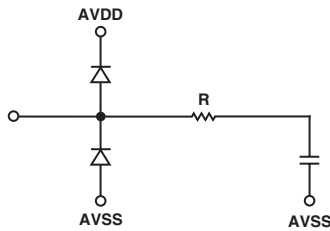

Figure 1. CCDIN

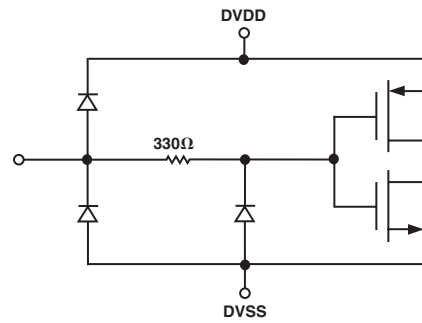

Figure 3. Digital Inputs

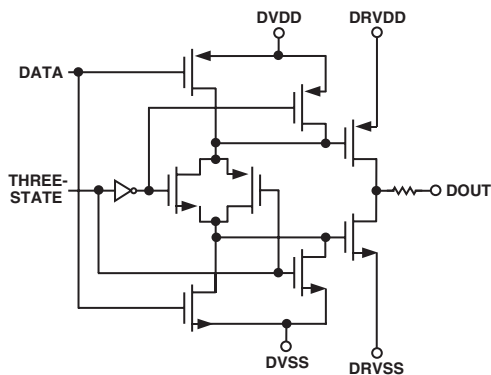

Figure 2. Digital Data Outputs

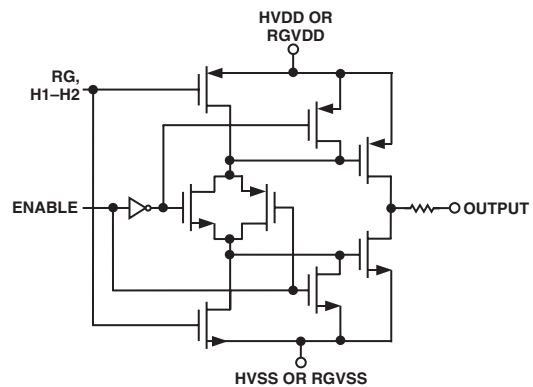
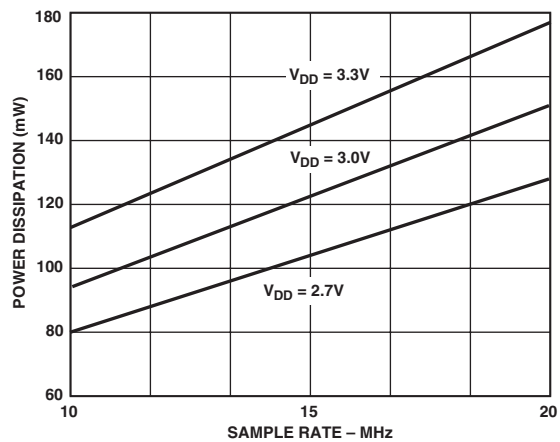
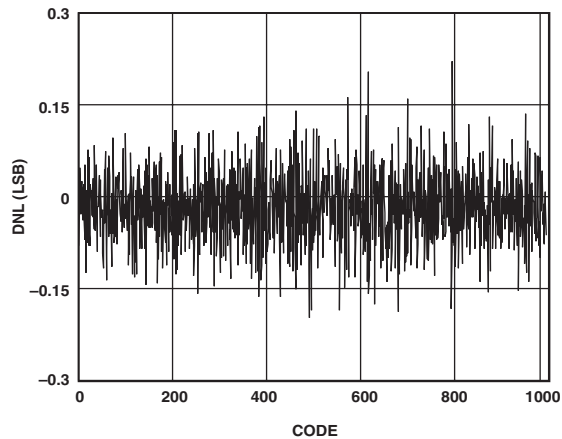

Figure 4. H1-H2, RG Drivers

Typical Performance Characteristics—AD9898



TPC 1. Power vs. Sample Rate



TPC 2. Typical DNL Performance

Table I. Control Register Address Map (Register Names Are Subject to Change)

Address	Content	Bit Width	Default Value	Register Name	Register Description
00	(23:0)	23	000000	SW_RESET	Software Reset = 000000. (Reset all registers to default.)
01	(23:21) 20 (19:18) 17 16 (15:14) 13 12 (11:10) (9:8) 7 6 5 4 (3:1) 0	3 1 2 1 1 2 1 1 2 2 1 1 1 3 1	0 0 1 1 0 0 0 0 0 0 1 1 0 0	 HBLKMASK SYNCPOL SUBCKMODE_HP SUBCKSUPPRESS MSHUTPAT MSHUT/VGATE_EN MSHUT/SUBCK_EN CLP_CONT CLP_MODE VDMODE	Unused Unused. Test Mode. Should be set = 0. Unused Masking Polarity for H1 during blanking period (0 = Low, 1 = High) External SYNC Active Polarity (0 = Active Low) Unused High Precision Shutter Mode Operation (0 = Single Pulse, 1 = Multiple Pulse) Suppress First SUBCK after Last VSG Line Pulse (0 = No Suppression, 1 = Suppression of 1 SUBCK) Unused Selects MSHUT Pattern (See Figure 44) (0 = MSHUTPAT0, 1 = MSHUTPAT1, 2 = MSHUTPAT2, 3 = MSHUTPAT3) MSHUT Masking of VGATE Input (0 = MSHUT does not mask VGATE, 1 = MSHUT does mask VGATE) MSHUT Masking of SUBCK (0 = MSHUT does not mask SUBCK, 1 = MSHUT does mask SUBCK) CLPOB Control (0 = CLPOB OFF, 1 = CLPOB ON) CLPOB CCD Region Control (See Table XII) Unused VD Synchronous/Asynchronous Mode Setting (0 = VD Synchronous, 1 = VD Asynchronous)
02	(23:22) (21:16) (15:14) (13:8) (7:6) (5:0)	2 6 2 6 2 6	0 0x34 0 0x18 0 0x0B	SHDLOC SHPLOC DCLKPHASE DOUTPHASE	Unused SHD Sample Location Unused SHP Sample Location DCLK Pulse Adjustment Data Output [9:0] Phase Adjustment
03	(23:17) 16 (15:14) (13:8) (7:6) (5:0)	7 1 2 6 2 6	0x00 0 0 0x00 0 0x10	H1BLKRETIME H1POSLOC RGNEGLOC	Unused Retimes the H1 HBLK to Internal Clock Unused H1 Positive Edge Location Unused RG Negative Edge Location
04	(23:22) (21:16) (14:12) 11 (10:8) (7:3) (2:0)	2 6 3 1 3 5 3	0 0x20 5 0 5 0x00 2	REFBLACK H2DRV H1DRV RGDRV	Unused Black Clamp Level H2 Drive Strength (0 = Off, 1 = 4.3 mA, 2 = 8.6 mA, 3 = 12.9 mA, 4 = 17.2 mA, 5 = 21.5 mA, 6 = 25.8 mA, 7 = 30.1 mA) Unused H1 Drive Strength (0 = Off, 1 = 4.3 mA, 2 = 8.6 mA, 3 = 12.9 mA, 4 = 17.2 mA, 5 = 21.5 mA, 6 = 25.8 mA, 7 = 30.1 mA) Unused RG Drive Strength (0 = Off, 1 = 2.15 mA, 2 = 4.2 mA, 3 = 6.45 mA, 4 = 8.6 mA, 5 = 10.75 mA, 6 = 12.9 mA, 7 = 15.05 mA)
05	(23:10) 9 8 (7:2) 1 0	14 1 1 6 1 1	0x0000 0 0 00 0 1	AFESTBY DIGSTBY OUTCONT_REG OUTCONT_ENB	Unused AFE Standby (0 = Standby , 1 = Normal Operation) Digital Standby (0 = Standby , 1 = Normal Operation) Unused Internal OUTCONT Signal Control (0 = Digital Outputs held at fixed dc level, 1 = Normal Operation) External OUTCONT Signal Input Pin 43 Control (0 = Pin Enabled, 1 = Pin Disabled)

Table I. Control Register Address Map (Register Names Are Subject to Change)

Address	Content	Bit Width	Default Value	Register Name	Register Description
0A (VD SyncReg)*	23	1	0		Unused
	22	1	0	FDPOL	FD Polarity Control (0 = Low, 1 = High)
	(21:16)	6	0x00	VSGMASK	VSG Masking (See Table XXIII)
	(15:12)	4	0	SYNCCNT	External SYNC Setting
	(11:10)	2	0	SVREP_MODE	Super Vertical Repetition Mode
	9	1	0	HBLKEXT	H Pulse Blanking Extend Control
	8	1	0	HPULSECNT	H Pulse Control during Blanking
	(7:4)	4	C	SPATLOGIC	SPAT Logic Setting (See Table XX)
	(3:2)	2	3	SVOS	Second V Output Setting (10 = Output Repetition 1)
1	1	0	SPAT_EN	SPAT Control (0 = SPAT Disable, 1 = SPAT Enable)	
0	1	0	MODE	Mode Control Bit (0 = Mode_A, 1 = Mode_B)	
0B (VD SyncReg)*	(23:22)	2	0		Unused
	21	1	1	SUBCK_EN	SUBCK Output Enable Control (0 = Disable, 1 = Enable)
	20	1	1	VSG_EN	VSG Output Enable Control (0 = Disable, 1 = Enable)
	(19:17)	3	0		Unused
	16	1	0	STROBE_EN	STROBE Output Control (0 = STROBE Output Held Low, 1 = STROBE Output Enabled)
	15	1	0		Unused
	(14:12)	3	0	SUBCKNUM_HP	High Precision Shutter SUBCLK Pulse Position/Number
11	1	0		Unused	
(10:0)	11	0x7FF	SUBCKNUM	Total Number of SUBCKs per Field	
0C (VD SyncReg)*	(23:21)	3	0		Unused
	20	1	0	MSHUTINIT	MSHUT Initialize (1 = Forces MSHUT Low)
	(19:18)	2	0		Unused
	17	1	0		Unused
	16	1	0	MSHUTEN	MSHUT Control (0 = MSHUT Held at Last State, 1 = MSHUT Output)
	15	1	0		Unused
	(14:12)	3	0	MSHUTPOS_HP	MSHUT Position during High Precision Operation
11	1	0		Unused	
(10:0)	11	0x000	MSHUTPOS	MSHUT Position during Normal Operation	
0D (VD SyncReg)*	(23:17)	7			Unused
	16	1	0	VSUBPOL	VSUB Active Polarity (0 = Low, 1 = High)
	(15:11)	5			Unused
(10:0)	11	0x000	VSUBTOG	VSUB Toggle Position. Active starting line in any field.	
0E (VD SyncReg)*	(23:21)	3	0		Unused
	20	1	0		Unused. Test Mode. Should be set = 0.
	(19:18)	2	0		Unused
	17	1	0		Unused. Test Mode. Should be set = 0.
	16	1	0		Unused. Test Mode. Should be set = 0.
	(15:10)	6	0x00		Unused
(9:0)	10	0x000	VGAGAIN	VGA Gain	
D5	(23:4)	20	0x00000		Unused
	3	1	1	DCLK2SEL	DCLK2 Selector (0 = Select Internal FD Signal to be Output on FD/DCLK2 Pin 16, 1 = Select CLI to be Output on FD/DCLK2 Pin 16)
	2	1	0	DCLK1SEL	DCLK1 Selector (0 = Select DLL Version for DCLK1 Output, 1 = Select CLI for DCLK1 Output)
	(1:0)	2	0	CLKDIV	Input Clock Divider (0 = No Division, 1 = 1/2, 2 = 1/3, 3 = 1/4)
D6	(23:1)	23	0x000000		Unused
	0	1	1	SLAVE_MODE	Operating Mode (0 = Master Mode, 1 = Slave Mode)

*This register defaults to VD synchronous mode type at power up. VD sync type registers do not get updated until the first falling edge of VD is asserted after the register has been programmed. VD sync type registers can be programmed to be asynchronous registers by setting VDMODE = 1 (Addr 0x01).

Table II. System Register Address Map (Addr 0x14)

Register	Content	Bit Width	Default (Decimal)	Register Name	Register Description
Sys_Reg(0)	(31:24) (23:0)	8 24	NA NA	System_Reg_Addr System_Number_N	System Register Address Is (Addr 0x14) Number N Register Writes (0x000000 = Write All Registers)
Sys_Reg(1)	(31:23) 22 21 20 19 (18:10) (9:1) 0	9 1 1 1 1 9 9 1	37 0 0 1 1 0 19 0	VTPLEN0 V1STARTPOL0 V2STARTPOL0 V3STARTPOL0 V4STARTPOL0 V1TOG1POS0 V1TOG2POS0 V2TOG1POS0 [8]	Vertical Sequence No. 0: Length between Repetitions Vertical Sequence No. 0: V1 Start Polarity Vertical Sequence No. 0: V2 Start Polarity Vertical Sequence No. 0: V3 Start Polarity Vertical Sequence No. 0: V4 Start Polarity Vertical Sequence No. 0: V1 Toggle Position 1 Vertical Sequence No. 0: V1 Toggle Position 2
Sys_Reg(2)	(31:24) (23:15) (14:6) (5:0)	8 9 9 6	12 31 0	V2TOG1POS0 [7:0] V2TOG2POS0 V3TOG1POS0 V3TOG2POS0 [8:3]	Vertical Sequence No. 0: V2 Toggle Position 1 Vertical Sequence No. 0: V2 Toggle Position 2 Vertical Sequence No. 0: V3 Toggle Position 1
Sys_Reg(3)	(31:29) (28:20) (19:11) (10:2) 1 0	3 9 9 9 1 1	19 12 31 104 0 0	V3TOG2POS0 [2:0] V4TOG1POS0 V4TOG2POS0 VTPLEN1 V1STARTPOL1 V2STARTPOL1	Vertical Sequence No. 0: V3 Toggle Position 2 Vertical Sequence No. 0: V4 Toggle Position 1 Vertical Sequence No. 0: V4 Toggle Position 2 Vertical Sequence No. 1: Length between Repetitions Vertical Sequence No. 1: V1 Start Polarity Vertical Sequence No. 1: V2 Start Polarity
Sys_Reg(4)	31 30 (29:21) (20:12) (11:3) (2:0)	1 1 9 9 9 3	1 1 18 58 47	V3STARTPOL1 V4STARTPOL1 V1TOG1POS1 V1TOG2POS1 V2TOG1POS1 V2TOG2POS1 [8:6]	Vertical Sequence No. 1: V3 Start Polarity Vertical Sequence No. 1: V4 Start Polarity Vertical Sequence No. 1: V1 Toggle Position 1 Vertical Sequence No. 1: V1 Toggle Position 2 Vertical Sequence No. 1: V2 Toggle Position 1
Sys_Reg(5)	(31:26) (25:17) (16:8) (7:0)	6 9 9 8	96 0 76	V2TOG2POS1 [5:0] V3TOG1POS1 V3TOG2POS1 V4TOG1POS1 [8:1]	Vertical Sequence No. 1: V2 Toggle Position 2 Vertical Sequence No. 1: V3 Toggle Position 1 Vertical Sequence No. 1: V3 Toggle Position 2
Sys_Reg(6)	31 (30:22) (21:13) 12 11 10 9 (8:0)	1 9 9 1 1 1 1 9	38 105 57 0 0 1 1 0	V4TOG1POS1 [0] V4TOG2POS1 VTPLEN2 V1STARTPOL2 V2STARTPOL2 V3STARTPOL2 V4STARTPOL2 V1TOG1POS2	Vertical Sequence No. 1: V4 Toggle Position 1 Vertical Sequence No. 1: V4 Toggle Position 2 Vertical Sequence No. 2: Length between Repetitions Vertical Sequence No. 2: V1 Start Polarity Vertical Sequence No. 2: V2 Start Polarity Vertical Sequence No. 2: V3 Start Polarity Vertical Sequence No. 2: V4 Start Polarity Vertical Sequence No. 2: V1 Toggle Position 1
Sys_Reg(7)	(31:23) (22:14) (13:5) (4:0)	9 9 9 5	29 19 48	V1TOG2POS2 V2TOG1POS2 V2TOG2POS2 V3TOG1POS2 [8:4]	Vertical Sequence No. 2: V1 Toggle Position 2 Vertical Sequence No. 2: V2 Toggle Position 1 Vertical Sequence No. 2: V2 Toggle Position 2
Sys_Reg(8)	(31:28) (27:19) (18:10) (9:1) 0	4 9 9 9 1	0 29 19 48	V3TOG1POS2 [3:0] V3TOG2POS2 V4TOG1POS2 V4TOG2POS2	Vertical Sequence No. 2: V3 Toggle Position 1 Vertical Sequence No. 2: V3 Toggle Position 2 Vertical Sequence No. 2: V4 Toggle Position 1 Vertical Sequence No. 2: V4 Toggle Position 2 Unused

Table II. System Register Address Map (Addr 0x14) (continued)

Register	Content	Bit Width	Default (Decimal)	Register Name	Register Description
Sys_Reg(9)	(31:23)	9	89	VTPLEN3	Vertical Sequence No. 3: Length between Repetitions
	22	1	0	V1STARTPOL3	Vertical Sequence No. 3: V1 Start Polarity
	21	1	0	V2STARTPOL3	Vertical Sequence No. 3: V2 Start Polarity
	20	1	1	V3STARTPOL3	Vertical Sequence No. 3: V3 Start Polarity
	19	1	1	V4STARTPOL3	Vertical Sequence No. 3: V4 Start Polarity
	(18:10)	9	0	V1TOG1POS3	Vertical Sequence No. 3: V1 Toggle Position 1
	(9:1)	9	60	V1TOG2POS3	Vertical Sequence No. 3: V1 Toggle Position 2
	0	1		V2TOG1POS3 [8]	
Sys_Reg(10)	(31:24)	8	30	V2TOG1POS3 [7:0]	Vertical Sequence No. 3: V2 Toggle Position 1
	(23:15)	9	90	V2TOG2POS3	Vertical Sequence No. 3: V2 Toggle Position 2
	(14:6)	9	0	V3TOG1POS3	Vertical Sequence No. 3: V3 Toggle Position 1
	(5:0)	6		V3TOG2POS3 [8:3]	
Sys_Reg(11)	(31:29)	3	60	V3TOG2POS3 [2:0]	Vertical Sequence No. 3: V3 Toggle Position 2
	(28:20)	9	30	V4TOG1POS3	Vertical Sequence No. 3: V4 Toggle Position 1
	(19:11)	9	90	V4TOG2POS3	Vertical Sequence No. 3: V4 Toggle Position 2
	(10:1)	10	0	HBLKHPOS	H1 Pulse ON Position during Blanking Period
	0	1			Unused
Sys_Reg(12)	(31:20)	12	2283	HDLEN*	12-Bit Gray Code HD Counter Value (Gray Code Number)
	(19:10)	10	130	HLEN	10-Bit HL Counter Value
	(9:1)	9	100	OLEN	9-Bit OL Counter Value
	0	1		BLEN [8]	
Sys_Reg(13)	(31:24)	8	0	BLEN[7:0]	9-Bit BL Counter Value
	(23:16)	8	118	MSHUTLEN	MSHUT Sequence Length
	(15:5)	11	1048	VSGTOG1_0	VSG Sequence No. 1 Toggle Position 1
	(4:0)	5		VSGTOG1_1 [10:6]	
Sys_Reg(14)	(31:26)	6	1198	VSGTOG1_1 [5:0]	VSG Sequence No. 2 Toggle Position 1
	(25:18)	8	60	VSGLEN	VSG Pulsewidth
	(17:9)	9	19	SUBCK1TOG1	SUBCK1 First Toggle Position
	(8:0)	9	88	SUBCK1TOG2	SUBCK1 Second Toggle Position
Sys_Reg(15)	(31:23)	9	19	SUBCK2TOG1	SUBCK2 First Toggle Position
	(22:14:)	9	88	SUBCK2TOG2	SUBCK2 Second Toggle Position
	(13:2)	12	2243	CLPTOG1*	CLPOB Toggle Position No. 1
	(1:0)	2		CLPTOG2 [11]*	
Sys_Reg(16)	(31:22)	10	2278	CLPTOG2 [10:0]*	CLPOB Toggle Position No. 2
	(21:18)	4	9	VDRISE	VD Toggle Position No. 1
	(17:8)	10	120	HDRISE	HD Toggle Position No. 2
	(7:0)	8			Unused

*Register value must be a gray code number. (See Gray Code Registers section.)

Table III. Mode_A Register Map (Addr 0x15)

Register	Content	Bit Width	Default (Decimal)	Register Name	Register Description
Mode_Reg(0)	(31:24)	8	NA	Mode_A_Addr	Mode_A Address Is (Addr 0x15)
	(23:0)	24	NA	Mode_A_Number_N	Number N Register Writes (0x000000 = Write All Registers)
Mode_Reg(1)	(31:21)	11	262	VDLEN	VD Counter Value
	(20:9)	12	1139	HDLASTLEN	Number of Pixels in Last Line (Gray Code Number)
	8	1	1	VSGSEL0	VSG1 Sequence Selector (See Table XXIII)
	7	1	0	VSGSEL1	VSG2 Sequence Selector (See Table XXIII)
	(6:0)	7	0	VSGACTLINE	VSG Active Line
Mode_Reg(2)	31	1	0	SUBCKSEL	Select one of two SUBCK Patterns
	(30:28)	3	0	VTPSEQPTR0	Vertical Transfer Sequence Region No. 0
	(27:25)	3	0	VTPSEQPTR1	Vertical Transfer Sequence Region No. 1
	(24:22)	3	0	VTPSEQPTR2	Vertical Transfer Sequence Region No. 2
	(21:19)	3	0	VTPSEQPTR3	Vertical Transfer Sequence Region No. 3
	(18:16)	3	0	VTPSEQPTR4	Vertical Transfer Sequence Region No. 4
	15	1	1	CLPEN0	CLPOB Output Control No. 1
	14	1	0	CLPEN1	CLPOB Output Control No. 2
	13	1	0	CLPEN2	CLPOB Output Control No. 3
	12	1	0	CLPEN3	CLPOB Output Control No. 4
	11	1	0	CLPEN4	CLPOB Output Control No. 5
	(10:3)	8	0	SCP1	Sequence Change Position No. 1
	(2:0)	3		SCP2	
Mode_Reg(3)	(31:27)	5	0	SCP2	Sequence Change Position No. 2
	(26:19)	8	0	SCP3	Sequence Change Position No. 3
	(18:11)	8	0	SCP4	Sequence Change Position No. 4
	(10:9)	2	0	VTPSEL0	Vertical Pattern Selection 0
	(8:7)	2	0	VTPSEL1	Vertical Pattern Selection 1
	(6:5)	2	0	VTPSEL2	Vertical Pattern Selection 2
	(4:3)	2	0	VTPSEL3	Vertical Pattern Selection 3
	(2:0)	3	3	VTPREP0	Number of Vertical Pulse Repetitions for Pattern0
Mode_Reg(4)	(31:29)	3	0	VTPREP1	Number of Vertical Pulse Repetitions for Pattern1
	(28:26)	3	0	VTPREP2	Number of Vertical Pulse Repetitions for Pattern2
	(25:23)	3	0	VTPREP3	Number of Vertical Pulse Repetitions for Pattern3
	(22:12)	11	0	SVREP0	Vertical Sweep Repetition Number for CCD Region0
	(11:1)	11	0	SVREP3	Vertical Sweep Repetition Number for CCD Region3
0	1			Unused	
Mode_Reg(5)	(31:19)	13	988	V1SPAT_TOG1	Polarity Change Position Start for V1 SPAT
	(18:6)	13	1138	V1SPAT_TOG2	Polarity Change Position End for V1 SPAT
	(5:0)	6		V2SPAT_TOG1	
Mode_Reg(6)	(31:25)	7	1078	V2SPAT_TOG1	Polarity Change Position Start for V2 SPAT
	(24:12)	13	1168	V2SPAT_TOG2	Polarity Change Position End for V2 SPAT
	(11:0)	12		V3SPAT_TOG1	
Mode_Reg(7)	31	1	958	V3SPAT_TOG1	Polarity Change Position Start for V3 SPAT
	(30:18)	13	1138	V3SPAT_TOG2	Polarity Change Position End for V3 SPAT
	(17:5)	13	988	V4SPAT_TOG1	Polarity Change Position Start for V4 SPAT
	(4:0)	5		V4SPAT_TOG2	
Mode_Reg(8)	(31:24)	8	1228	V4SPAT_TOG2	Polarity Change Position End for V4 SPAT
	(23:11)	13	1392	SECONDVPOS	Second V Pattern Output Position
	(10:9)	2	3	VPATSECOND	Selected Second V Pattern Group for VSG Active Line
	(8:0)	9			Unused

Table IV. Mode_B Register Map (Addr 0x16)

Register	Content	Bit Width	Default (Decimal)	Register Name	Register Description
Mode_Reg(0)	(31:24) (23:0)	8 24	NA NA	Mode_B_Addr Mode_B_Number_N	Mode_B Address Is (Addr 0x16) Number N Register Writes (0x000000 = Write All Registers)
Mode_Reg(1)	(31:21) (20:9) 8 7 (6:0)	11 12 1 1 7	262 1139 1 0 0	VDLEN HDLASTLEN* VSGSEL0 VSGSEL1 VSGACTLINE	VD Counter Value Number of Pixels in Last Line (Gray Code Number) VSG1 Sequence Selector (See Table XXIII) VSG2 Sequence Selector (See Table XXIII) VSG Active Line
Mode_Reg(2)	31 (30:28) (27:25) (24:22) (21:19) (18:16) 15 14 13 12 11 (10:3) (2:0)	1 3 3 3 3 3 1 1 1 1 1 8 3	0 0 0 0 0 0 1 0 0 0 0 0 0	SUBCKSEL VTPSEQPTR0 VTPSEQPTR1 VTPSEQPTR2 VTPSEQPTR3 VTPSEQPTR4 CLPEN0 CLPEN1 CLPEN2 CLPEN3 CLPEN4 SCP1 SCP2	Select One of Two SUBCK Patterns Vertical Transfer Sequence Region No. 0 Vertical Transfer Sequence Region No. 1 Vertical Transfer Sequence Region No. 2 Vertical Transfer Sequence Region No. 3 Vertical Transfer Sequence Region No. 4 CLPOB Output Control No. 1 CLPOB Output Control No. 2 CLPOB Output Control No. 3 CLPOB Output Control No. 4 CLPOB Output Control No. 5 Sequence Change Position No. 1
Mode_Reg(3)	(31:27) (26:19) (18:11) (10:9) (8:7) (6:5) (4:3) (2:0)	5 8 8 2 2 2 2 3	0 0 0 0 0 0 0 3	SCP2 SCP3 SCP4 VTPSEL0 VTPSEL1 VTPSEL2 VTPSEL3 VTPREP0	Sequence Change Position No. 2 Sequence Change Position No. 3 Sequence Change Position No. 4 Vertical Pattern Selection 0 Vertical Pattern Selection 1 Vertical Pattern Selection 2 Vertical Pattern Selection 3 Number of VTP0 Pulse Repetitions for Pattern0
Mode_Reg(4)	(31:29) (28:26) (25:23) (22:12) (11:1) 0	3 3 3 11 11 1	0 0 0 0 0 0	VTPREP1 VTPREP2 VTPREP3 SVREP0 SVREP3	Number of VTP1 Pulse Repetitions for Pattern1 Number of VTP2 Pulse Repetitions for Pattern2 Number of VTP0 Pulse Repetitions for Pattern3 Vertical Sweep Repetition Number for CCD Region0 Vertical Sweep Repetition Number for CCD Region3 Unused
Mode_Reg(5)	(31:19) (18:6) (5:0)	13 13 6	988 1138	V1SPAT_TOG1 V1SPAT_TOG2 V2SPAT_TOG1	Polarity Change Position Start for V1 SPAT Polarity Change Position End for V1 SPAT
Mode_Reg(6)	(31:25) (24:12) (11:0)	7 13 12	1078 1168	V2SPAT_TOG1 V2SPAT_TOG2 V3SPAT_TOG1	Polarity Change Position Start for V2 SPAT Polarity Change Position End for V2 SPAT
Mode_Reg(7)	31 (30:18) (17:5) (4:0)	1 13 13 5	958 1138 988	V3SPAT_TOG1 V3SPAT_TOG2 V4SPAT_TOG1 V4SPAT_TOG2	Polarity Change Position Start for V3 SPAT Polarity Change Position End for V3 SPAT Polarity Change Position Start for V4 SPAT
Mode_Reg(8)	(31:24) (23:11) (10:9) (8:0)	8 13 2 9	1228 1392 3	V4SPAT_TOG2 SECONDVPOS VPATSECOND	Polarity Change Position End for V4 SPAT Second V Pattern Output Position Selected Second V Pattern Group for VSG Active Line Unused

*Register value must be a gray code number. (See Gray Code Registers section.)

AD9898

SYSTEM OVERVIEW

Figure 5 shows the typical system block diagram for the AD9898. The CCD output is processed by the AD9898's AFE circuitry, which consists of a CDS, VGA, black level clamp, and A/D converter. The digitized pixel information is sent to the digital image processor chip, which performs the postprocessing and compression. To operate the CCD, all CCD timing parameters are programmed into the AD9898 from the system microprocessor, through the 3-wire serial interface. From the system master clock, CLI, provided by the image processor or external crystal, the AD9898 generates all the CCD's horizontal and vertical clocks and all internal AFE clocks. External synchronization is provided by a SYNC pulse from the microprocessor, which will reset internal counters and resynchronize the VD and HD outputs.

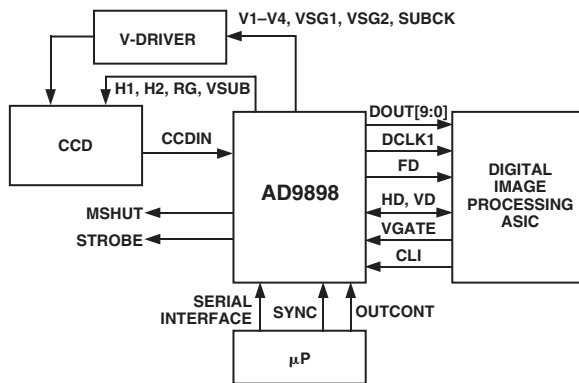

Figure 5. Typical System Block Diagram, Master Mode

The AD9898 powers up in slave mode, in which the VD and HD are provided externally from the image processor. In this mode, all AD9898 timing will be synchronized with VD and HD. The H-drivers for H1-H2 and RG are included in the AD9898, allowing these clocks to be directly connected to the CCD. H-drive voltage of up to 3.6 V is supported. An external V-driver is required for the vertical transfer clocks, the sensor gate pulses, and the substrate clock. The AD9898 also includes programmable MSHUT and STROBE outputs, which may be used to trigger mechanical shutter and strobe (flash) circuitry.

Figure 6 shows the horizontal and vertical counter dimensions for the AD9898. All internal horizontal and vertical clocking is programmed using these dimensions and is used to specify line and pixel locations.

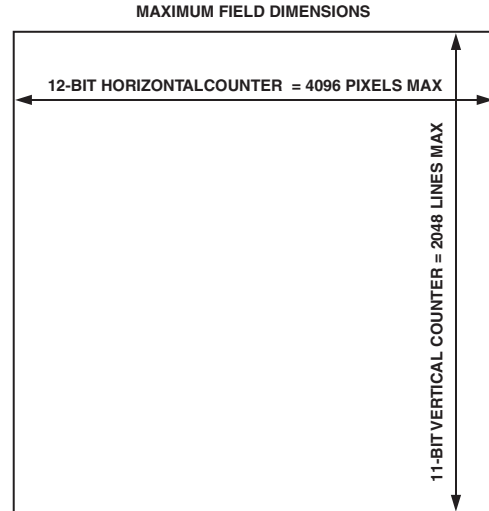

Figure 6. Horizontal and Vertical Counters

CLI INPUT CLOCK DIVIDER

The AD9898 provides the capability of dividing the CLI input clock using register CLKDIV (Addr 0xD5). The following procedure must be followed to reset the AFE and digital circuits when CLKDIV is reprogrammed back to 0 from CLKDIV = 1, 2, or 3. The DCLK1 output will become unstable if this procedure is not followed:

- Step 1: CLKDIV = 1, 2, or 3 (CLI divided by setting value)
- Step 2: CLKDIV = 0 (CLI reprogrammed for no division)
- Step 3: DIGSTBY = AFESTBY = 0
- Step 4: DIGSTBY = AFESTBY = 1

GRAY CODE REGISTERS

Table V lists the AD9898 registers requiring gray code values. Below is an example of applying a gray code number for HDLEN using a line length of 1560 pixels:

$$\text{HDLEN} = (1560 - 4) = 1556_{10}$$

(See Table XI note about HDLEN.)

$$1556_{10} = 0x51E$$

The gray code value of 0x51E would be programmed in the 12-bit HDLEN register.

Table V. Gray Code Registers

Register Name	Register Type
HDLEN	System_Reg(12)
CLPTOG1	System_Reg(15)
CLPTOG2	System_Reg(15 and 16)
HDLASTLEN	Mode_Reg(1)

SERIAL INTERFACE TIMING

All of the internal registers of the AD9898 are accessed through a 3-wire serial interface. The interface consists of a clock (SCK), serial load (SL), and serial data (SDATA).

The AD9898 has three different register types that are configured by the 3-wire serial interface. They are control registers, system registers, and mode registers and are described in Table VI.

Table VI. Type of Serial Interface Registers

Register	Address	No. of Registers
Control	0x00 through 0xD6	There is a 24-bit register at each address. Not all addresses are used. See Table I.
System	0x14	Seventeen 32-bit system registers at Address 0x14. See Table II.
Mode_A	0x15	Eight 32-bit Mode_A registers at Address 0x15. See Table III.
Mode_B	0x16	Eight 32-bit Mode_B registers at Address 0x16. See Table IV.

Control Register Serial Interface

The control register 3-wire interface timing requirements are shown in Figure 7. Control data must be written into the device one address at a time due to the noncontiguous address spacing for the control registers. This requires eight bits of address data followed by 24 bits of configuration data between each active low period of SL for each address. The SL signal must be kept high for at least one full SCK cycle between successive writes to control registers.

System Register Serial Interface

There are seventeen 32-bit system registers that get accessed sequentially at Address 0x14 beginning with Sys_Reg[0]. When writing to the system registers, SDATA contains the 8-bit address of 0x14, followed by Number Writes N[23:0], followed by the Sys_Reg[31:0] data as shown in Figure 8. The system register map is listed in Table II.

There are two options available when writing to the system registers. The choice is automatically determined by the value of the Number Writes N[23:0] word. If Number Writes N[23:0] = 0x000000, the device gets put into a mode where it expects all 17 Sys_Reg[31:0] data-words to be clocked in before SL is asserted high. If the Number Writes N[23:0] is decoded as some number N other than 0x000000, the device expects N number of registers to be programmed where N is equal to the value of Number Writes N[23:0]. For example, if Number Writes N[23:0] = 0x000004, the device would expect data to be provided for Sys_Reg[3:0]. In all cases, the system registers would be written to begin with Sys_Reg[0], no matter what the value of Number Writes N[23:0] is. Note that SL can be brought high or low during access to system registers, as shown in Figure 8.

Mode_A and Mode_B Register Serial Interface

There are eight 32-bit Mode_A and eight 32-bit Mode_B registers that get accessed sequentially at Address 0x15 and Address 0x16, respectively. The Mode_A and Mode_B registers get written to exactly as the system registers are. (See the description above.) The mode registers are listed in Tables III and IV.

Changing operation between Mode_A and Mode_B is done by setting the 1-bit MODE register (Addr 0x0A). The desired Mode_A (Addr 0x15) or Mode_B (Addr 0x16) data must be programmed into the Mode_A or Mode_B registers before changing the MODE bit.

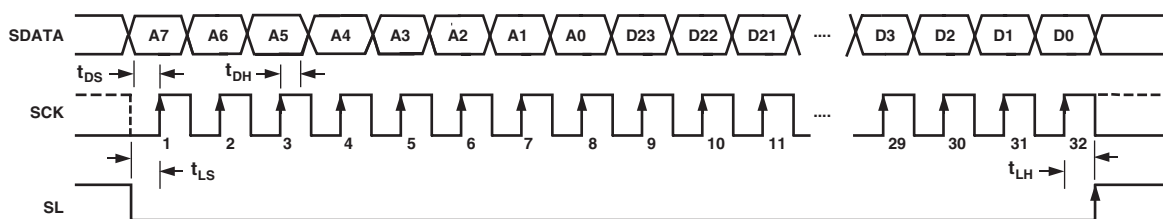

1. SDATA BITS ARE INTERNALLY LATCHED ON THE RISING EDGES OF SCK.
2. SYSTEM UPDATE OF LOADED REGISTERS OCCURS ON SL RISING EDGE.
3. THIS TIMING PATTERN MUST BE WRITTEN FOR EACH REGISTER WRITE WITH SL REMAINING HIGH FOR AT LEAST ONE FULL SCK PERIOD BEFORE ASSERTING SL LOW AGAIN FOR THE NEXT REGISTER WRITE.

Figure 7. 3-Wire Serial Interface Timing for Control Registers

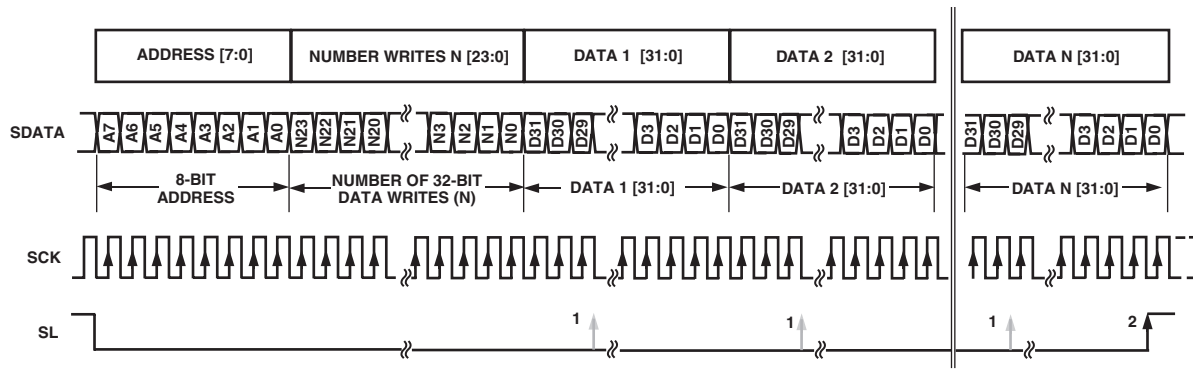

1. ALL SL PULSES ARE IGNORED UNTIL THE LSB OF THE LAST DATA N WORD IS CLOCKED IN.
2. VALID SL PULSE. SL MUST BE ASSERTED HIGH WHEN ALL SDI DATA TRANSMISSIONS HAVE BEEN FINISHED.

Figure 8. System and Mode Register Writes

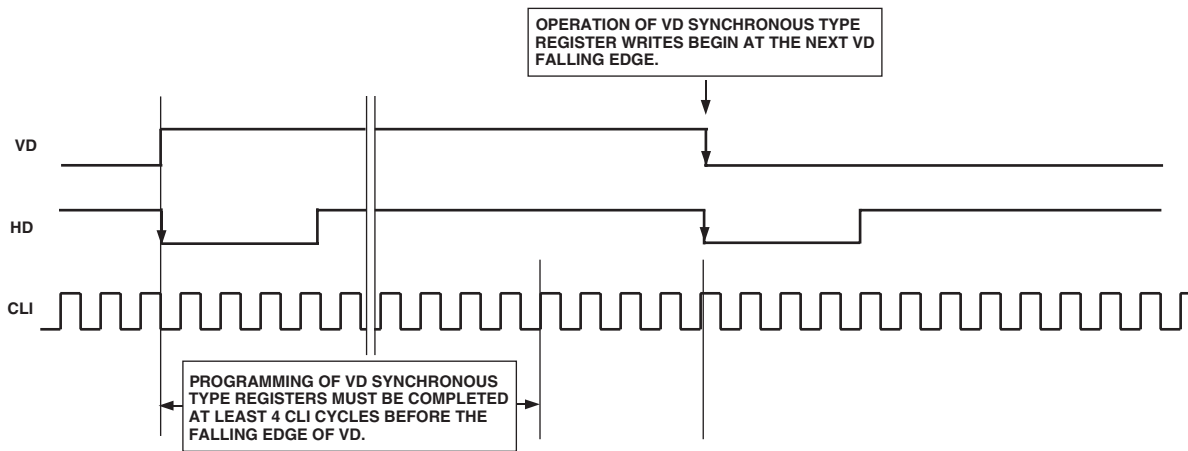

Figure 9. VD Synchronous Type Register Writes

VD SYNCHRONOUS AND ASYNCHRONOUS REGISTER OPERATION

There are two types of control registers, VD synchronous and VD asynchronous, as indicated in the address column of Table I. Register writes to synchronous and asynchronous type registers operate differently, as described below. Writes to system, Mode_A, and Mode_B registers occur asynchronously.

Asynchronous Register Operation

For VD asynchronous register writes, SDATA data is stored directly into the serial register at the rising edge of SL. As a result, register operation begins immediately after the rising edge of SL.

VD Synchronous Register Operation

For VD synchronous type registers, SDATA data is temporarily stored in a buffer register at the rising edge of SL. This data is held in the buffer register until the next falling edge of VD is applied. Once the next falling edge of VD occurs, the buffered SDATA data is loaded into the serial register and the register operation begins (see Figure 9).

All control registers at the following addresses are VD Synchronous type registers—Addr: 0x0A, 0x0B, 0x0C, 0x0D, and 0x0E (see Table I).

ANALOG FRONT END (AFE) DESCRIPTION AND OPERATION

The AD9898 AFE signal processing chain is shown in Figure 10. Each processing step is essential to achieving a high quality image from the raw CCD pixel data. Registers for the AD9898 AFE section are listed in Table VII.

DC Restore

To reduce the large dc offset of the CCD output signal, a dc restore circuit is used with an external 0.1 μF series coupling capacitor. This restores the dc level of the CCD signal to approximately 1.5 V, which is compatible with the 3 V analog supply of the AD9898.

Correlated Double Sampler

To extract the video information and reject low frequency noise, the CDS circuit samples each CCD pixel twice. The timing shown in Figure 12 illustrates how the two internally generated CDS clocks, SHP and SHD, are used to sample the reference level and the data level of the CCD signal, respectively. The placement of the SHP and SHD sampling edges is determined by the setting of the SHPLOC (Addr 0x02) and SHDLOC (Addr 0x02) registers. Placement of these two clock edges is critical to achieving the best performance from the CCD.

Table VII. AFE Registers

Register Name	Bit Width	Register Type	Description
VGAGAIN	10	Control (Addr 0x0E)	VGA Gain
REFBLACK	6	Control (Addr 0x04)	Blk Clamp Level
AFESTBY	1	Control (Addr 0x05)	AFE Standby

PRECISION TIMING HIGH SPEED TIMING GENERATION

The AD9898 generates flexible high speed timing signals using the Precision Timing core. This core is the foundation for generating the timing used for both the CCD and the AFE signals, including the reset gate RG, the horizontal drivers H1–H2, and the CDS sample clocks. By providing precise control over the horizontal CCD readout and the AFE correlated double sampling, the unique architecture of the AD9898 makes optimizing image quality a routine task for a system designer.

Timing Resolution

The Precision Timing core uses a 1 \times master clock input (CLI) as a reference. This clock should be the same as the CCD pixel clock frequency. Figure 11 illustrates how the internal timing core divides the master clock period into 48 steps or edge positions. Using a 20 MHz CLI frequency for the AD9898, the edge resolution of the Precision Timing core is 1 ns. A 40 MHz CLI frequency can be applied where the AD9898 will internally divide the CLI frequency by two. Division by one-third and one-fourth is also provided. CLI frequency division is controlled using the CLKDIV (Addr 0xD5) register.

High Speed Clock Programmability

Figure 13 shows how the high speed clocks RG, H1–H2, SHP, and SHD are generated. The RG pulse has a fixed rising edge and a programmable falling edge. The horizontal clock H1 has a programmable rising and a fixed falling edge occurring at H1POSLOC + 24 steps. The H2 clock is always the inverse of H1. Table VIII summarizes the high speed timing registers and the parameters for the high speed clocks. Each register is six bits wide with the 2 MSB used to select the quadrant region as outlined in Table VIII. Figure 13 shows the range and default locations of the high speed clock signals.

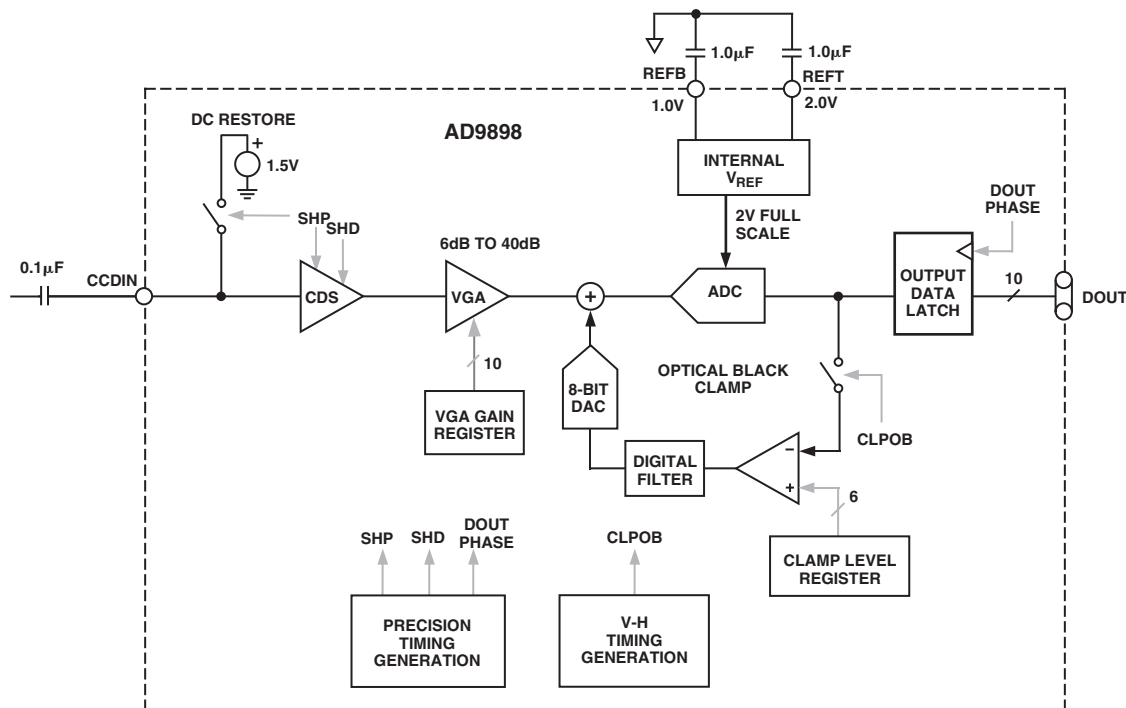

Figure 10. AFE Block Diagram

AD9898

H-Driver and RG Outputs

In addition to the programmable timing positions, the AD9898 features on-chip output drivers for the RG and H1–H2 outputs. They are sufficiently powerful to directly drive the CCD inputs. The H-driver current can be adjusted for optimum rise/fall time into a particular load by using the H1DRV and H2DRV registers (Addr 0x04). The RG drive current is adjustable using the RGDRV register (Addr 0x04). The H1DRV and H2DRV register is adjustable in 4.3 mA increments. The RGDRV register is adjustable in 2.15 mA increments. All DRV registers have a setting of 0 equal to OFF or three-state, and the maximum setting of 7.

As shown in Figure 13, the H2 output is the inverse of H1. The internal propagation delay resulting from the signal inversion is less than 1 ns, which is significantly less than the typical rise time driving the CCD load. This results in an H1/H2 crossover voltage of approximately 50% of the output swing. The crossover voltage is not programmable.

Digital Data Outputs

The AD9898 DOUT[9:0] and DCLK phases are independently programmable using the DOUTPHASE register (Addr 0x02) and DCLKPHASE register (Addr 0x02) (see Figure 15).

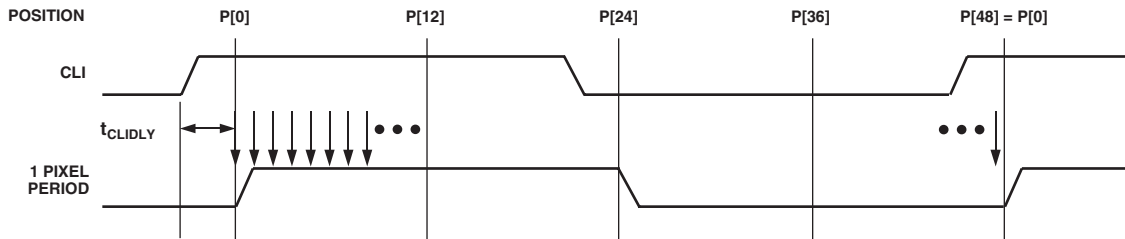

1. PIXEL CLOCK PERIOD IS DIVIDED INTO 48 POSITIONS, PROVIDING FINE EDGE RESOLUTION FOR HIGH SPEED CLOCKS.
2. THERE IS A FIXED DELAY FROM THE CLI INPUT TO THE INTERNAL PIXEL PERIOD POSITIONS ($t_{CLIDLy} = 6 \text{ ns TYP}$).

Figure 11. High Speed Clock Resolution from CLI Master Clock Input

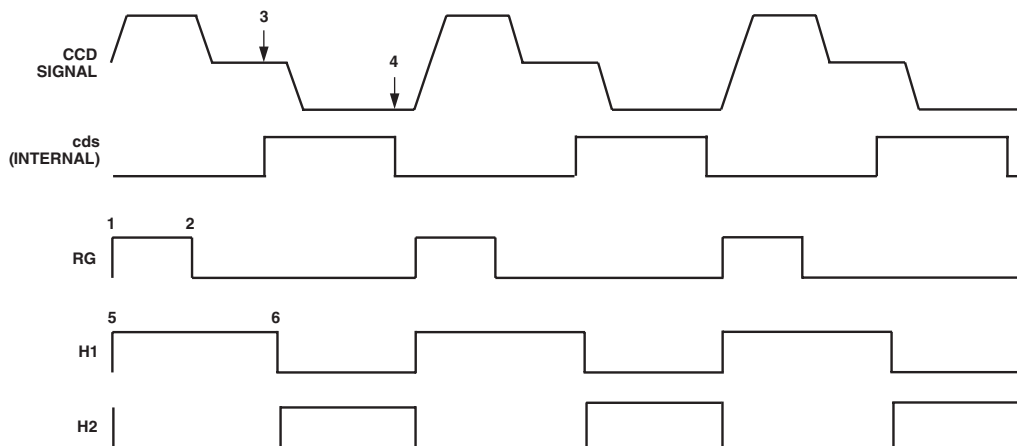

- PROGRAMMABLE CLOCK POSITIONS
1. RG RISING EDGE (FIXED EDGE AT 000000).
 2. RG FALLING EDGE (RGNEGLOC (ADDR 0x03)).
 3. SHP SAMPLE LOCATION (SHPLOC (ADDR 0x02)).
 4. SHD SAMPLE LOCATION (SHDLOC (ADDR 0x02)).
 5. H1 RISING EDGE LOCATION (H1POSLOC (ADDR 0x03))
 6. H1 NEGATIVE EDGE LOCATION (FIXED AT (H1POSLOC + 24 STEPS)).
 7. H2 IS ALWAYS THE INVERSE OF H1.

Figure 12. High Speed Clock Programmable Locations

Table VIII. RG, H1, SHP, SHD, DCLK, and DOUTPHASE Timing Parameters

Register Name	Bit Width	Register Type	Range	Description
RGNEGLOC	6	Control (Addr 0x03)	0–47 Edge Location	Falling Edge Location for RG
H1POSLOC	6	Control (Addr 0x03)	0–47 Edge Location	Positive Edge Location for H1
SHPLOC	6	Control (Addr 0x02)	0–47 Edge Location	Sample Location for SHP
SHDLOC	6	Control (Addr 0x02)	0–47 Edge Location	Sample Location for SHD
DOUTPHASE	6	Control (Addr 0x02)	0–47 Edge Location	Phase Location of Data Output [9:0]
DCLKPHASE	6	Control (Addr 0x02)	0–47 Edge Location	Positive Edge of DCLK 1

The 2 MSB are used to select the quadrant.

Table IX. Precision Timing Edge Locations for RG, H1, SHP, SHD, DCLK, and DOUTPHASE

Signal Name	Quadrant	RG Rising Edge (Not Programmable)	RG Falling Edge	
			RGNEGLOC	Quadrant Range
RG	I	Fixed at 000000	000000 to 001011	P[0] to P[11]
	II	Fixed at 000000	010000 to 011011	P[12] to P[23]
	III	Fixed at 000000	100000 to 101011	P[24] to P[35]
	IV	Fixed at 000000	110000 to 111011	P[36] to P[47]

Signal Name	Quadrant	H1 Rising Edge		H1 Falling Edge (Not Programmable)
		H1POSLOC	Quadrant Range	
H1	I	000000 to 001011	P[0] to P[11]	H1POSLOC + 24 Steps
	II	010000 to 011011	P[12] to P[23]	H1POSLOC + 24 Steps
	III	100000 to 101011	P[24] to P[35]	H1POSLOC + 24 Steps
	IV	110000 to 111011	P[36] to P[47]	H1POSLOC + 24 Steps

Signal Name	Quadrant	cds Rising Edge		cds Falling Edge	
		SHPLOC	Quadrant Range	SHDLOC	Quadrant Range
cds	I	000000 to 001011	P[0] to P[11]	000000 to 001011	P[0] to P[11]
	II	010000 to 011011	P[12] to P[23]	010000 to 011011	P[12] to P[23]
	III	100000 to 101011	P[24] to P[35]	100000 to 101011	P[24] to P[35]
	IV	110000 to 111011	P[36] to P[47]	110000 to 111011	P[36] to P[47]

Signal Name	Quadrant	Data Output[9:0] Rising Edge		Data Output[9:0] Falling Edge (Not Programmable)
		DOUTPHASE	Quadrant Range	
Data Output[9:0]	I	000000 to 001011	P[0] to P[11]	DOUTPHASE + 24 Steps
	II	010000 to 011011	P[12] to P[23]	DOUTPHASE + 24 Steps
	III	100000 to 101011	P[24] to P[35]	DOUTPHASE + 24 Steps
	IV	110000 to 111011	P[36] to P[47]	DOUTPHASE + 24 Steps

Signal Name	DCLKPHASE Value	DCLKPHASE Rising Edge	DCLKPHASE Falling Edge
DCLK1	00	P[6]	P[26]
	01	P[16]	P[36]
	10	P[26]	P[06]
	11	P[36]	P[16]

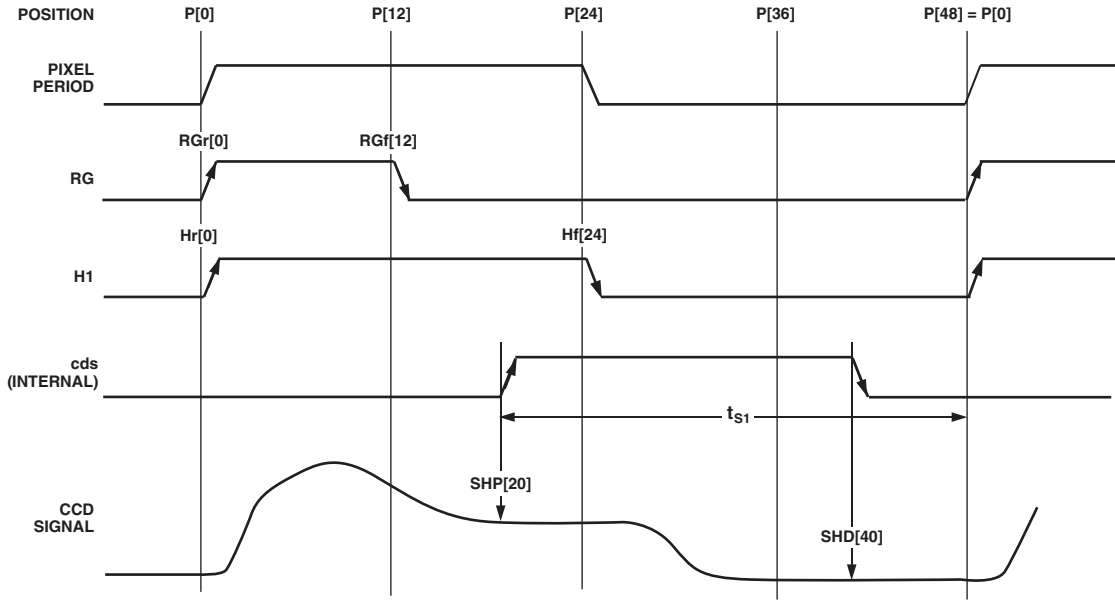

1. ALL SIGNAL EDGES ARE FULLY PROGRAMMABLE TO ANY OF THE 48 POSITIONS WITHIN ONE PIXEL PERIOD.
2. DEFAULT POSITIONS FOR EACH SIGNAL ARE SHOWN.

Figure 13. High Speed Clock Default and Programmable Locations

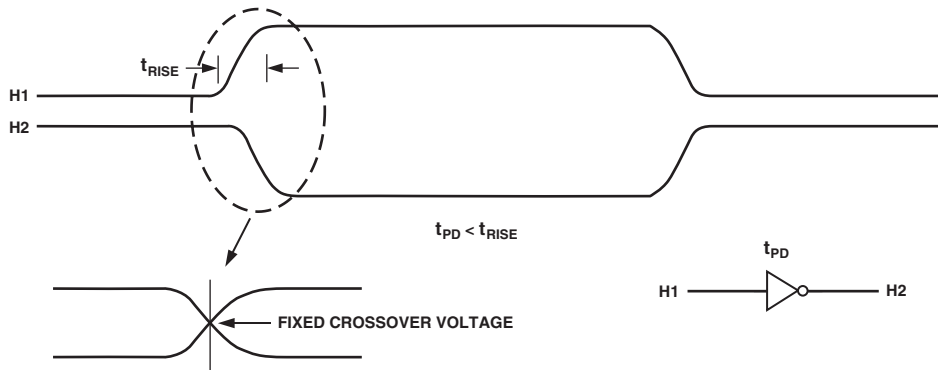
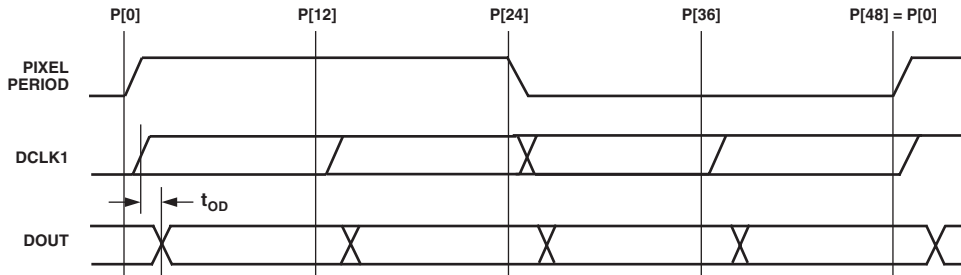

Figure 14. H-Clock Inverse Phase Relationship



1. DCLK1 PHASE IS ADJUSTED BY SETTING THE DCLKPHASE REGISTER (ADDR 0x02).
2. DOUT PHASE CAN BE ADJUSTED BY SETTING THE DOUTPHASE REGISTER (ADDR 0x02).

Figure 15. Digital Output Phase Adjustment

EXTERNAL SYNCHRONIZATION (MASTER MODE)

External synchronization can be used to synchronize the VD and HD signal by applying an external pulse on the SYNC/ VGATE pin (Pin 45) for master mode operation. The SYNC/ VGATE pin is configured as an external SYNC input for master mode operation by setting the SLAVE_MODE register (Addr 0xD6) = 0. (The AD9898 defaults to slave mode at power-up.)

SYNCCNT (Addr 0x0A) and SYNCPOL (Addr 0x01) are the only two registers used for configuring the AD9898 for external synchronization. The SYNCPOL is a 1-bit register used for configuring the SYNC input as either active low or active high. The AD9898 defaults to active low at power-up. The function of the SYNCCNT register is described in Table X. Figures 16 and 17 provide two examples of external synchronization with SYNCPOL = 0.

Table X. External Synchronization (Master Mode)

SYNCCNT	External Synchronization Options
0	Disable External Synchronization
1	VD Sync at every SYNC Pulse
2	VD Sync after Second Applied SYNC Pulse
3	VD Sync after Third Applied SYNC Pulse
4	VD Sync after Fourth Applied SYNC Pulse
5	VD Sync after Fifth Applied SYNC Pulse
6	VD Sync after Sixth Applied SYNC Pulse
7	VD Sync after Seventh Applied SYNC Pulse
8	VD Sync after Eighth Applied SYNC Pulse
9	VD Sync after Ninth Applied SYNC Pulse
10	VD Sync after Tenth Applied SYNC Pulse
11	VD Sync after Eleventh Applied SYNC Pulse
12	VD Sync after Twelfth Applied SYNC Pulse
13	VD Sync after Thirteenth Applied SYNC Pulse
14	VD Sync after Fourteenth Applied SYNC Pulse
15	VD Sync after First Applied SYNC Pulse Only

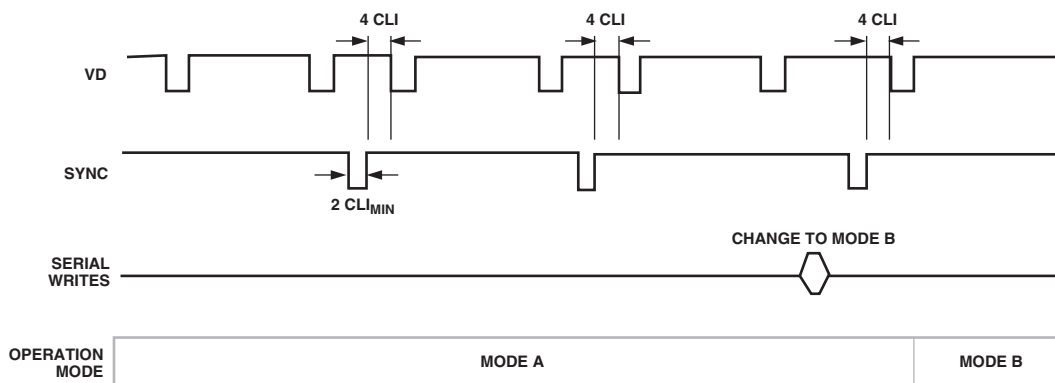

Figure 16. Example of Synchronization with SYNCPOL = 0 and SYNCCNT = 1

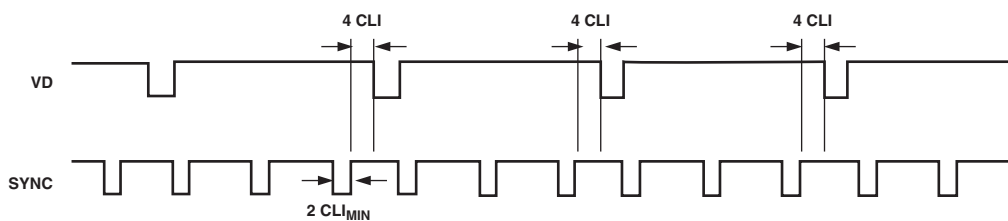

Figure 17. Example of Synchronization with SYNCPOL = 0 and SYNCCNT = 3

AD9898

HORIZONTAL AND VERTICAL SYNCHRONOUS TIMING

The HD and VD output pulses are programmable using the registers listed in Table XI. The HD output is asserted low at the start of the horizontal line shift. The VD output is asserted low at the start of each line. As shown in Figure 18, the 11-bit VD counter is used to count the number of lines set by the VDLEN register. The 12-bit HD counter is used to count the number of pixels in each line set by the HDLEN register. For example, if the CCD array size is 2000 lines by 2100 pixels per line, VDLEN = 2000 and HDLEN = 0xC28. The HLEN register sets the HL counter that is used as a reference for the rising edge of the HD pulse.

Special Note about the HDLEN Register

The 12-bit HD counter value must be programmed using a gray code number. There is also a 4-clock cycle setup period that must be considered when determining the HDLEN register value, as shown in Figure 18. As a result of the 4-clock cycle setup period, the value of HDLEN is always equal to the actual number of pixels per line minus four. For example, if there are 2100 pixels per line, HDLEN equals $(2100 - 4) = 2096$. The gray code value of 2096 is 0xC28, which is what would be programmed in the HDLEN register.

Table XI. HD and VD Registers

Register Name	Bit Width	Register Type	Reference Counter	Range	Description
HDLEN	12	Sys_Reg(12)		0–4095 Pixels	12-Bit Gray Code Counter Value
HLEN	10	Sys_Reg(12)		0–1023 Pixels	10-Bit HL Counter Value
HDRISE	10	Sys_Reg(16)	HL	0–1023 Pixels	HD Rise Position
HDLASTLEN*	12	Mode_Reg(1)	HD	0–4095 Pixels	HD Last Line Length
VDLEN	11	Mode_Reg(1)		0–2047 Lines	VD Counter Value
VDRISE	4	Sys_Reg(16)	VD	0–15 Lines	VD Rise Position

*Register value must be a gray code number. (See Gray Code Registers section.)

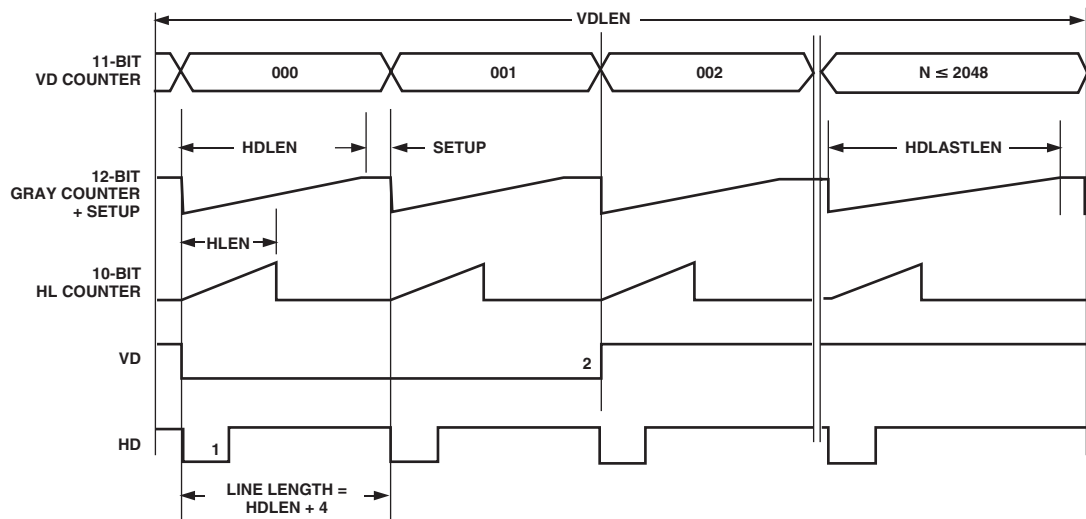

1. THE SETUP DELAY IS 4 CLI CYCLES. THE ACTUAL LENGTH OF ONE LINE IS 4 MORE CYCLES THAN THE VALUE SET IN HDLEN AND HDLASTLEN DUE TO SETUP DELAY.
2. VDRISE REFERENCES THE 11-BIT VD COUNTER.
3. HDRISE REFERENCES THE 10-BIT HL COUNTER.

PROGRAMMABLE CLOCK POSITIONS
 1. HDRISE (SYS_REG(16))
 2. VDRISE (SYS_REG(16))

Figure 18. VD and HD Horizontal Timing

Table XII. CLPOB Registers

Register Name	Bit Width	Register Type	Reference Counter	Range	Description
CLP_CONT	1	Control (0x01)			CLPOB Control (0 = CLPOB Off, 1 = CLPOB On)
CLP_MODE	1	Control(0x01)			CLPOB CCD Region Control (0 = Enable CLPENx Register Settings, 1 = Disable CLPENx Register Settings)
CLPTOG1	12	Sys_Reg(15)	HD	0–4095 Pixel Locations	CLPOB Toggle Position 1 (Gray Code Number)
CLPTOG2	12	Sys_Reg(15 and 16)	HD	0–4095 Pixel Locations	CLPOB Toggle Position 2 (Gray Code Number)
CLPEN0	1	Mode_Reg(2)			CLPOB Control for CCD Region 0 (0 = CLPOB Disabled, 1 = CLPOB Enabled)
CLPEN1	1	Mode_Reg(2)			CLPOB Control for CCD Region 1 (0 = CLPOB Disabled, 1 = CLPOB Enabled)
CLPEN2	1	Mode_Reg(2)			CLPOB Control for CCD Region 2 (0 = CLPOB Disabled, 1 = CLPOB Enabled)
CLPEN3	1	Mode_Reg(2)			CLPOB Control for CCD Region 3 (0 = CLPOB Disabled, 1 = CLPOB Enabled)
CLPEN4	1	Mode_Reg(2)			CLPOB Control for CCD Region 4 (0 = CLPOB Disabled, 1 = CLPOB Enabled)

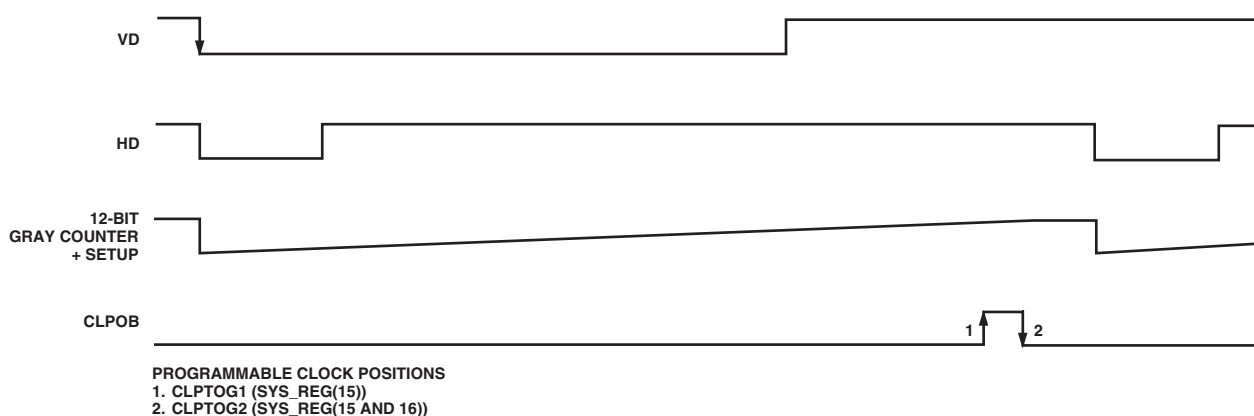

Figure 19. Location of CLPOB Using CLPTOG1 and CLPTOG2 Registers

HORIZONTAL CLAMPING AND BLANKING

The AD9898's horizontal clamping and blanking pulses are programmable to suit a variety of applications. Similar to vertical timing generation, individual sequences are defined for each signal and are then organized into multiple regions during image readout. This allows the dark pixel clamping and blanking patterns to be changed at each stage of the readout to accommodate different image transfer timing and high speed line shifts.

Controlling CLPOB Clamp Pulse Timing

The AFE horizontal CLPOB pulse is generated based on the 12-bit gray code counter. Once the length of the 12-bit gray code counter is set using the HDLEN register (Sys_Reg(12)), CLPTOG1 and CLPTOG2 registers (Sys_Reg(15 and 16)) can be used to place the CLPOB pulse location, as shown in Figure 19. Table XII lists all CLPOB registers that are used to configure and control the placement and output of the CLPOB pulse.

The length of the last HD line is set using the HDLASTLEN register (Sys_Reg(1)). Figure 20 shows that no CLPOB pulse will be asserted when the last HD length set by HDLASTLEN is shorter than the regular HD length set by HDLEN.

Figure 21 shows that no CLPOB pulse will be applied when the last HD length set by HDLASTLEN is longer than the regular HD length. Note that the CLPOB pulse is applied in the last line only when HDLASTLEN = HDLEN.

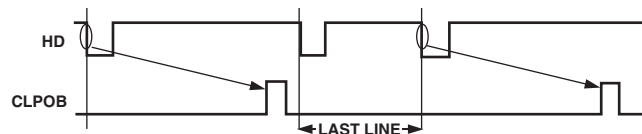

Figure 20. Last HD Shorter Than Regular HD

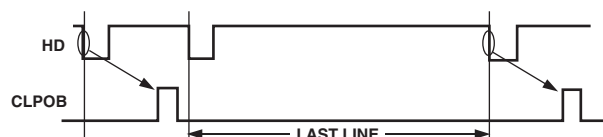

Figure 21. Last HD Longer Than Regular HD

Controlling CLPOB Clamp Pulse Outputs

The registers in Table XII are used for programming the CLPOB pulse, which will be disabled in all CCD regions by setting CLPCNT = 0. The CLPTOG_x (x = 0, 1) are used to set the CLPOB toggle positions. The CLPEN_x (x = 0, 1, 2, 3, and 4) are used to enable or disable the CLPOB pulse separately in each CCD region when CLPMODE = 0. The CLPEN registers have no effect if CLPMODE = 1. In this case, the CLPOB pulse will be asserted in all CCD regions, regardless of the value set in the CLPEN_x registers.

Figure 22 shows an example of the CLPOB pulse being disabled in CCD Regions 1 and 3 by setting CLPEN₁ = 1 and CLPEN₃ = 1. Note that the CLPOB pulse remains disabled in the first line of the following CCD region.

Table XIII. SCP and CLPEN

SCP[4:1]	CLPEN[4:0]
SCP0*	CLPEN0
SCP1	CLPEN1
SCP2	CLPEN2
SCP3	CLPEN3
SCP4	CLPEN4

*SCP0 is not a programmable register and therefore is not listed in the register map tables. SCP0 is a fixed sequence and always starts at the falling edge of VD. Although this register is not programmable, the CLPEN0 register is still used to enable or disable the CLPOB pulse for the SCP0 region.

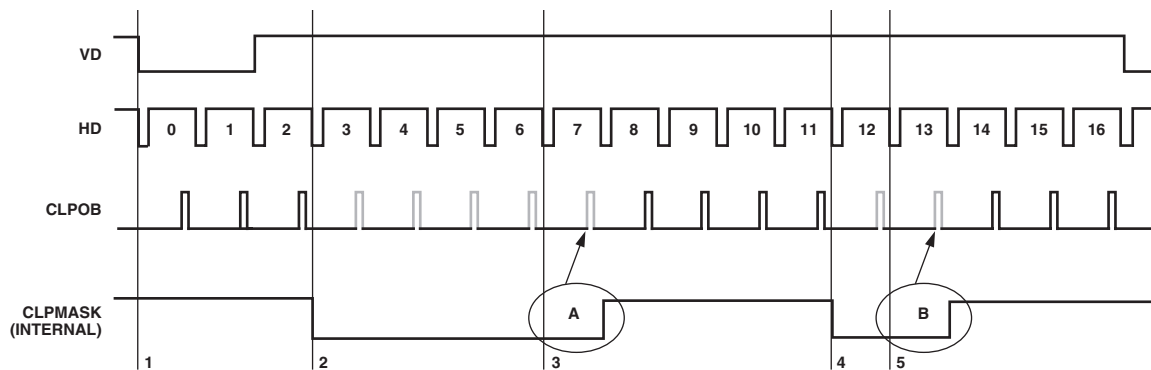

- PROGRAMMING POSITIONS**
1. SCP0 = 0 (FIXED), CLPEN0 = 1
 2. SCP1 = 3, CLPEN1 = 0
 3. SCP2 = 4, CLPEN2 = 1
 4. SCP3 = 5, CLPEN3 = 0
 5. SCP4 = 1, CLPEN4 = 1

NOTE
THE INTERNAL CLPMASK SIGNAL EXTENDS ONE EXTRA HD CYCLE FROM THE TIME WHEN THE CLPMASK PERIOD CHANGES FROM LOW TO HIGH. AS A RESULT, ONE ADDITIONAL CLPOB PULSE IS MASKED, AS SHOWN AT POSITIONS A AND B.

Figure 22. CLPOB Outputs with CLPMODE = 0

H1 AND H2 BLANKING

The AD9898 provides three options for controlling the period where H1 and H2 pulses get blanked. These options are normal H blanking, selective positioning for 2 H1 and H2 outputs, and extended blanking. In all cases, HBLKMASK is used to set the polarity of H1 during the blanking period. Table XIV describes the registers used to control H blanking.

Normal H Blanking

For normal H blanking operation, HPULSECNT = 0 and HBLKMASK = 0 or 1. The HBLKHPOS register is not used in this mode. Figure 23 shows one example where HBLKMASK = 0. As seen in Figure 23, H1 and H2 are blanked while HD is Low.

Selective Positioning for Two H1 and H2 Outputs

For selective positioning operation, HPULSECNT = 1 and HBLKMASK = 0 or 1. In this mode, two H1 pulses are output during the blanking period. The location of these two pulses are set using the HBLKHPOS register, as shown in Figure 24.

Extended Blanking

Extended blanking is enabled by setting HBLKEXT = 1. The HBLKEXT register uses the 9-bit BL counter to suspend operation of the HD and HL counters. This delays the blanking period by the length set in the BLEN register as shown in Figure 25.

Table XIV. H1 Blanking Registers

Register Name	Bit Width	Register Type	Description
HBLKMASK	1	Control (0x01)	Masking Polarity for H1 during Blanking Period ¹ (0 = Low, 1 = High)
HPULSECNT	1	Control (0x0A)	H Pulse Control during Blanking Period (0 = No Output during Blanking, 1 = Output during Blanking)
HBLKEXT	1	Control (0x0A)	H Pulse Blanking Extend Control ² (0 = Extended Blanking Disabled, 1 = Extended Blanking Enabled)
H1BLKRETIME	1	Control (0x03)	Retimes the H1 HBLK to Internal Clock (0 = Retiming Disabled, 1 = Retiming Enabled)
HBLKHPOS	10	Sys_Reg(11)	H1 Pulse ON Position during Blanking Period

NOTES

¹The polarity of H2 is always the opposite polarity of the H1 polarity.

²The HBLKEXT extend control extends the blanking period by the number of counts set in the BLEN register for the 9-bit BL counter.

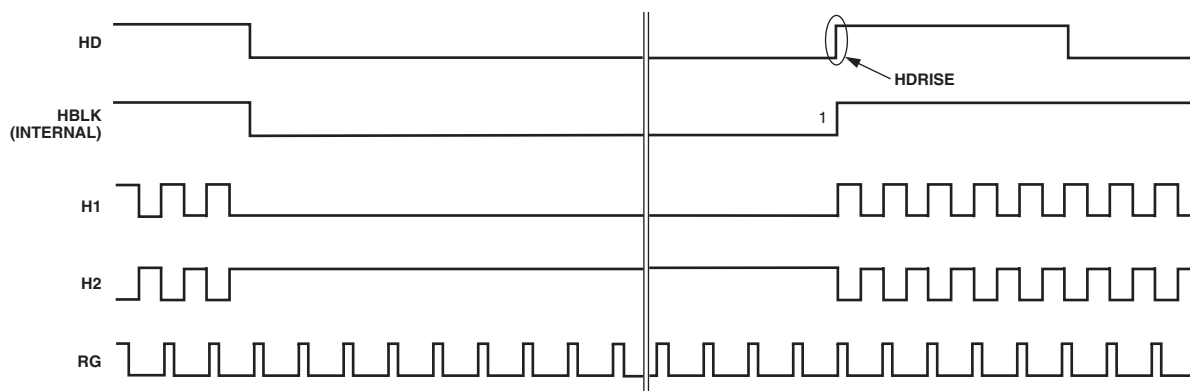

1. THE RISING EDGE OF HBLK IS ALWAYS THE SAME AS HDRISE.

Figure 23. Normal H-Blanking Operation HBLKMASK = 0, HPULSECNT = 0, HBLKHPOS = xxx

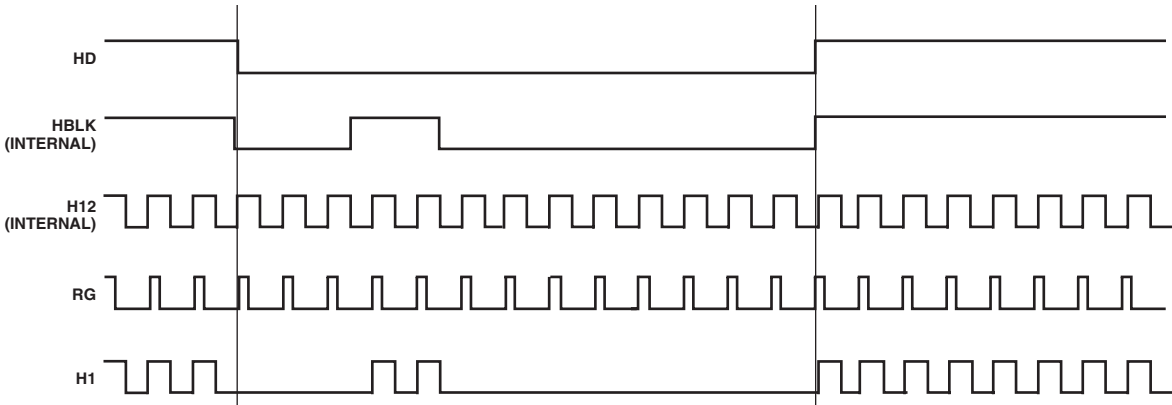

THE H2 POLARITY IS OPPOSITE THE POLARITY OF H1.

Figure 24. Selective H-Blanking Operation $HBLKMASK = 0$, $HPULSECNT = 1$, $HBLKHPOS = 003$

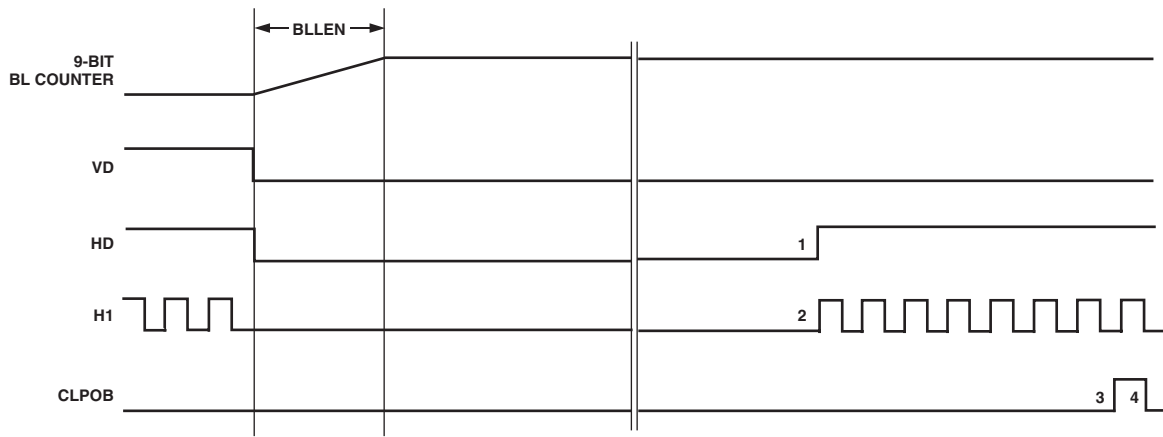

1. POSITIONS 1, 2, 3, AND 4 ARE DELAYED BY THE VALUE OF THE BL COUNTER.
2. VSG1, VSG2, V1-V4, AND SUBCK PULSES ARE NOT DELAYED BY THE BL COUNTER.

Figure 25. VD, HD, and H1 Extended Blanking Operation $HBLKEXT = 1$

VGATE MASKING OF V1-V4 AND CLPOB OUTPUTS

During slave mode operation, the SYNC/VGATE, Pin 45, is configured as an input for an external VGATE signal. While operating in this mode, the external VGATE signal can be used to mask the V1-V4 and CLPOB outputs. There are two options available for masking the V1-V4 and CLPOB outputs. The selection is made by setting the MSHUT/VGATE_EN register located at Control Addr 0x01. Examples of these two options are shown in Figures 26 and 27.

Figure 26 shows an example of MSHUT/VGATE_EN = 0. In this example, the VGATE signal is internally latched on the falling edge of HD, resulting in the V1-V4 and CLPOB outputs being masked when the internally latched VGATE signal is High.

Figure 27 shows an example when MSHUT/VGATE_EN = 1. In this example, the preprogrammed MSHUT signal blocks the VGATE input from masking V1-V4 and CLPOB outputs while MSHUT is Low. The internally latched VGATE signal will only mask V1-V4 and CLPOB when MSHUT is High while operating in this mode.

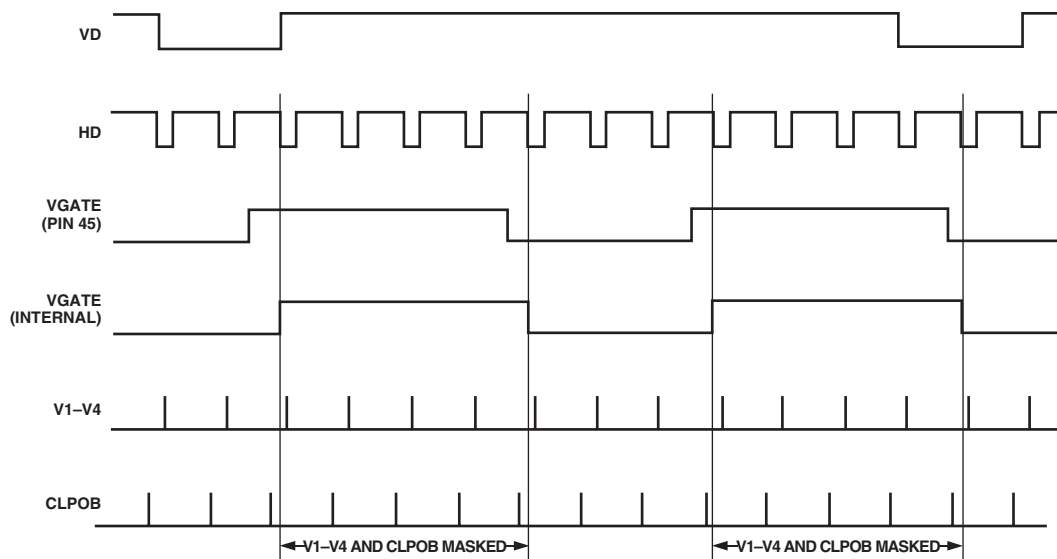

Figure 26. Example of VGATE Input Masking V1-V4 and CLPOB Outputs with MSHUT/VGATE_EN = 0

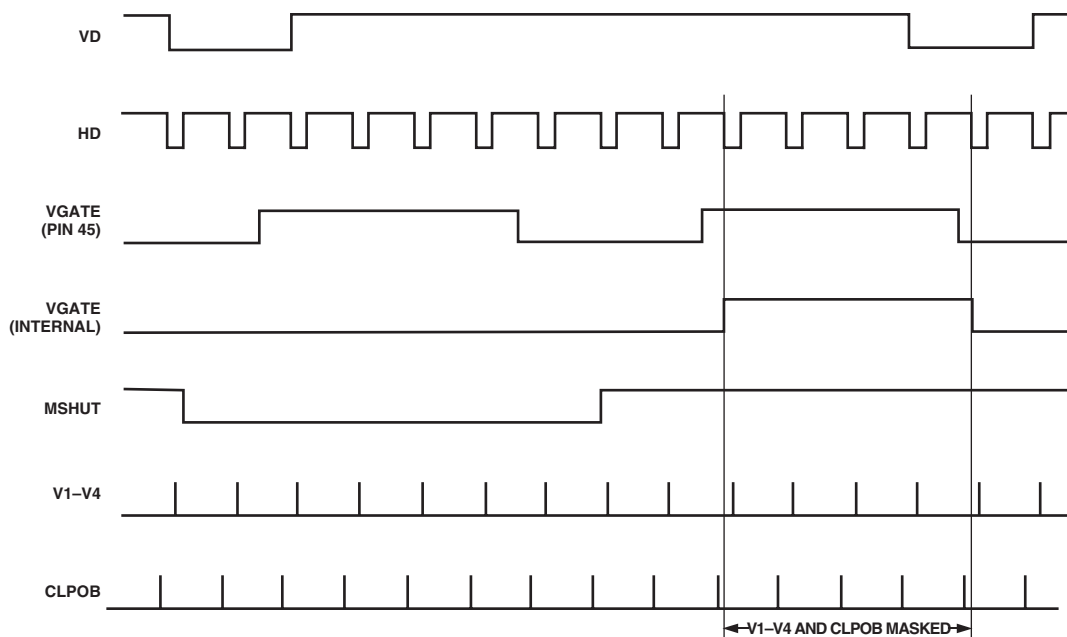

Figure 27. Example of VGATE Input Masking V1-V4 and CLPOB Outputs with MSHUT/VGATE_EN = 1

AD9898

VERTICAL TIMING GENERATION

The AD9898 provides a very flexible solution for generating vertical CCD timing and can support multiple CCDs and different system architectures. The 4-phase vertical transfer clocks V1–V4 are used to shift each line of pixels into the horizontal output register of the CCD. The AD9898 vertical outputs can be individually programmed into four different vertical pulse patterns identified as VTP0, VTP1, VTP2, and VTP3. Each vertical pulse pattern is a unique set of preconfigured V1–V4 sequences. Once the vertical patterns have been configured using the registers in Table XVII, pointer registers are used to select which region of the CCD a particular vertical pattern is output in. The pointer registers are described in Table XV.

Up to five unique CCD regions may be specified. The readout of the entire field is constructed by combining one or more of the individual regions sequentially. With up to five region areas available, different steps of the readout, such as high speed line shifts and vertical image transfer, can be supported.

Creating Vertical Sequences

Figures 28, 29, and 30 provide an overview of how the vertical timing is generated in four basic steps.

Step 1

Create the Individual Pulses for Patterns VTP0, VTP1, VTP2, and VTP3 (See Figure 28)

The registers shown in Table XV are used to generate the individual vertical timing pulses, as shown in Figure 28. The VTPLEN_x determines the number of pixels between pulse repetitions. The start polarity (V_xSTARTPOL_x) sets the starting polarity of the vertical sequence and can be programmed high or low. The first toggle position (V_xTOG1POS_x) and second toggle position (V_xTOG2POS_x) are the pixel locations within the line where the pulse transitions.

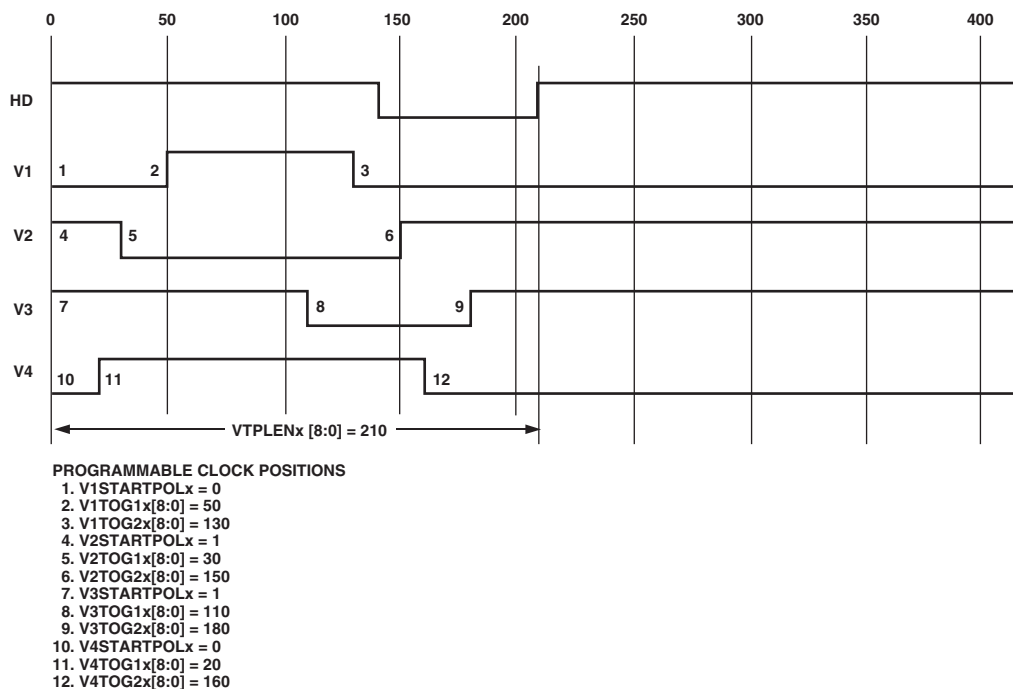

Figure 28. Step 1: Create Individual Vertical Pulses for VTP0, VTP1, VTP2, and VTP3 Patterns

Step 2

Create the Individual Vertical Sequences (See Figure 29)

The individual vertical sequences are created by assigning pulse repetitions to patterns VTP0, VTP1, VTP2, and VTP3, using VTPREP_x registers in Table XVI. The number of repetitions (VTPREP_x) determines the number of pulse repetitions desired within a single line. Programming 1 for VTPREP_x gives a single pulse, while setting it to 0 will provide a fixed dc output based on the start polarity value. Figure 29 shows an example of a VTP_x sequence of two VTP_x patterns made by setting VTPREP_x = 2.

Step 3

Output Vertical Sequences into CCD Regions (See Figure 30)

The AD9898 arranges individual sequences into CCD regions through the use of sequence pointers (VTPSEQPTR_x) and vertical transfer pattern select (VTPSEL_x) registers, as described in Table XVI. The VTPSEQPTR_x registers are used to point to a desired VTPSEL_x register whose value determines what VTP_x pattern will be output on the V1–V4 pins. For example, if VTPSEQPTR0 = 1 and VTPSEL1 = 2, the VTP2 pulse pattern would output while operating in Region 0 of the CCD.

Step 4

Combining CCD Regions (See Figure 30)

The entire field readout can be built by combining multiple regions by using mode registers SCP0, SCP1, SCP2, SCP3, and SCP4.

The individual CCD regions are combined into a complete field readout using the sequence change position (SCP_x) pointers as described in Table XVII. Figure 30 shows how each field is divided into multiple regions which allows the user to change vertical timing during various stages of the image readout. The boundaries of each region are defined by the sequence change position (SCP). Each SCP is an 8-bit value representing the line number boundary region. A total of four SCPs allow up to five different regions in the field to be defined. The first SCP0 is always hard coded to line zero, and the remaining four SCPs are register programmable.

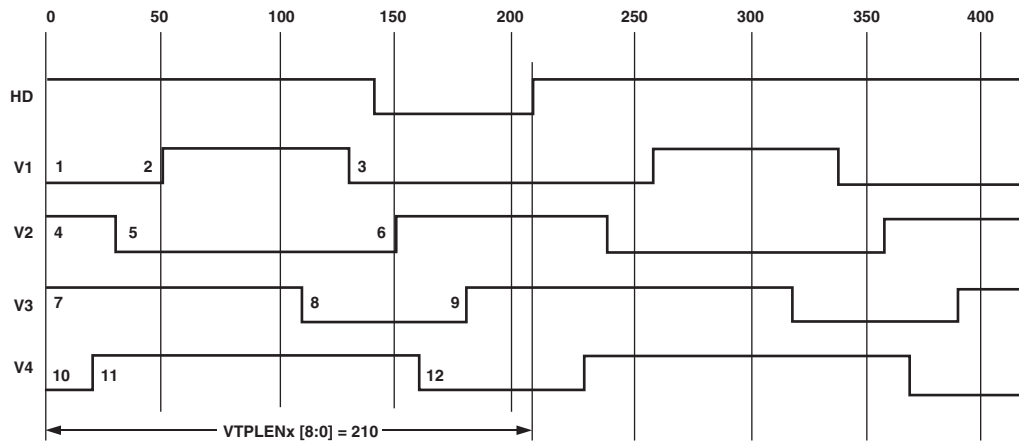

Figure 29. Step 2: Create Individual Sequences for V1–V4 Outputs by Assigning Pulse Repetitions to VTP0, VTP1, VTP2, and VTP3 Patterns. This Example Shows VTPREPx = 2.

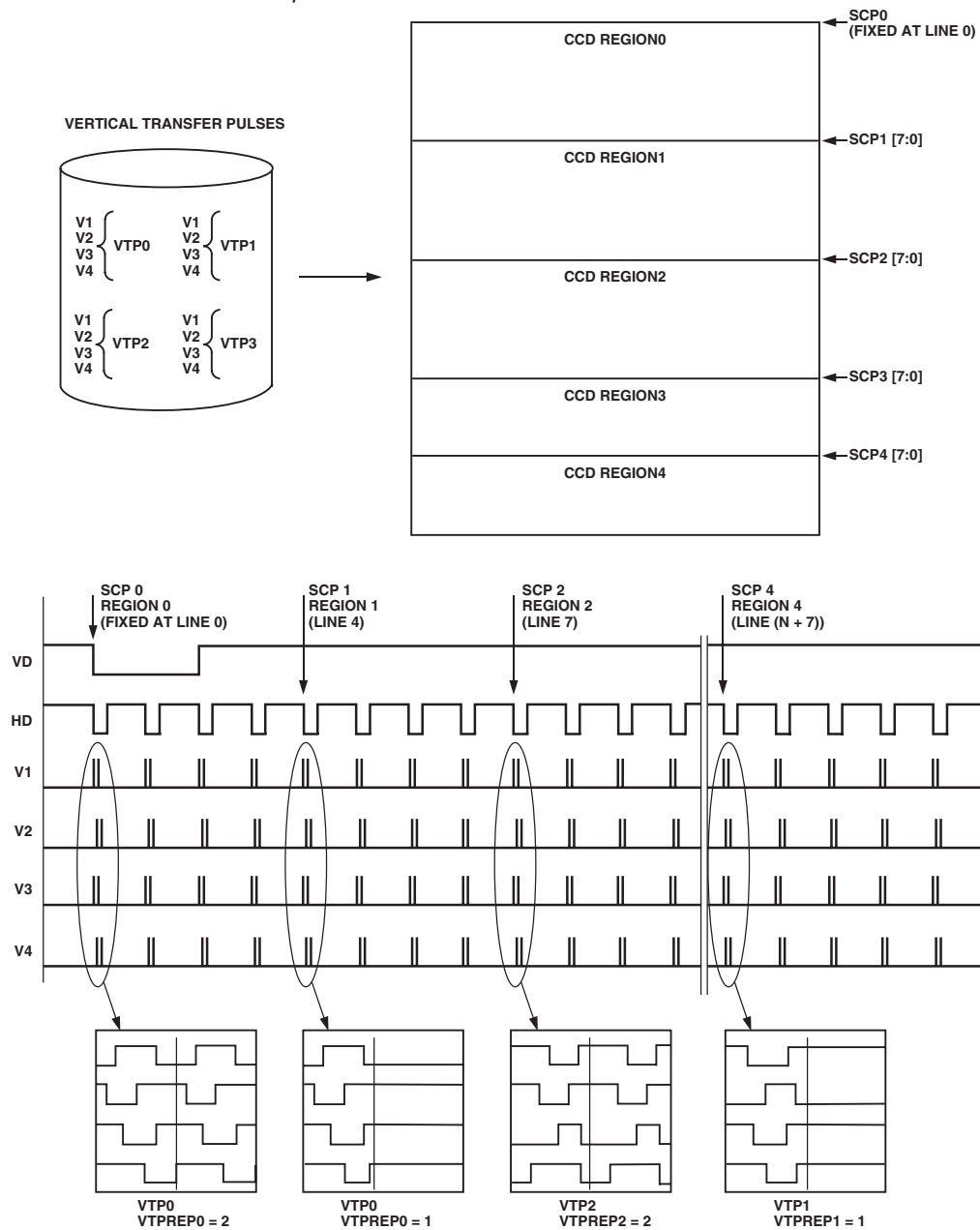

Figure 30. Steps 3 and 4: Example of Building an Entire Field Readout by Assigning Sequences to Multiple CCD Regions

Table XV. V1-V4 Registers to Configure V1-V4 Pulse for Each VTP Pattern

Register Name	Bit Width	Register Type	Reference Counter	Range	Description	VTP Pattern
VTPLEN0	9	Sys_Reg(1)	V Counter	0-511	Length between Repetitions	V T P 0
V1STARTPOL0	1	Sys_Reg(1)		High/Low	V1 Starting Polarity for VTP0 (0 = LO, 1 = HI)	
V2STARTPOL0	1	Sys_Reg(1)		High/Low	V2 Starting Polarity for VTP0 (0 = LO, 1 = HI)	
V3STARTPOL0	1	Sys_Reg(1)		High/Low	V3 Starting Polarity for VTP0 (0 = LO, 1 = HI)	
V4STARTPOL0	1	Sys_Reg(1)		High/Low	V4 Starting Polarity for VTP0 (0 = LO, 1 = HI)	
V1TOG1POS0	9	Sys_Reg(1)	V Counter	0-511	V1 Toggle Position 1 for VTP0	
V1TOG2POS0	9	Sys_Reg(1)	V Counter	0-511	V1 Toggle Position 2 for VTP0	
V2TOG1POS0	9	Sys_Reg(1 and 2)	V Counter	0-511	V2 Toggle Position 1 for VTP0	
V2TOG2POS0	9	Sys_Reg(2)	V Counter	0-511	V2 Toggle Position 2 for VTP0	
V3TOG1POS0	9	Sys_Reg(2)	V Counter	0-511	V3 Toggle Position 1 for VTP0	
V3TOG2POS0	9	Sys_Reg(2 and 3)	V Counter	0-511	V3 Toggle Position 2 for VTP0	
V4TOG1POS0	9	Sys_Reg(3)	V Counter	0-511	V4 Toggle Position 1 for VTP0	
V4TOG2POS0	9	Sys_Reg(3)	V Counter	0-511	V4 Toggle Position 2 for VTP0	
VTPLEN1	9	Sys_Reg(3)	V Counter	0-512	Length between Repetitions	
V1STARTPOL1	1	Sys_Reg(3)		High/Low	V1 Starting Polarity for VTP1 (0 = LO, 1 = HI)	
V2STARTPOL1	1	Sys_Reg(3)		High/Low	V2 Starting Polarity for VTP1 (0 = LO, 1 = HI)	
V3STARTPOL1	1	Sys_Reg(4)		High/Low	V3 Starting Polarity for VTP1 (0 = LO, 1 = HI)	
V4STARTPOL1	1	Sys_Reg(4)		High/Low	V4 Starting Polarity for VTP1 (0 = LO, 1 = HI)	
V1TOG1POS1	9	Sys_Reg(4)	V Counter	0-511	V1 Toggle Position 1 for VTP1	
V1TOG2POS1	9	Sys_Reg(4)	V Counter	0-511	V1 Toggle Position 2 for VTP1	
V2TOG1POS1	9	Sys_Reg(4)	V Counter	0-511	V2 Toggle Position 1 for VTP1	
V2TOG2POS1	9	Sys_Reg(4 and 5)	V Counter	0-511	V2 Toggle Position 2 for VTP1	
V3TOG1POS1	9	Sys_Reg(5)	V Counter	0-511	V3 Toggle Position 1 for VTP1	
V3TOG2POS1	9	Sys_Reg(5)	V Counter	0-511	V3 Toggle Position 2 for VTP1	
V4TOG1POS1	9	Sys_Reg(5 and 6)	V Counter	0-511	V4 Toggle Position 1 for VTP1	
V4TOG2POS1	9	Sys_Reg(6)	V Counter	0-511	V4 Toggle Position 2 for VTP1	
VTPLEN2	9	Sys_Reg(6)	V Counter	0-512	Length between Repetitions	V T P 2
V1STARTPOL2	1	Sys_Reg(6)		High/Low	V1 Starting Polarity for VTP2 (0 = LO, 1 = HI)	
V2STARTPOL2	1	Sys_Reg(6)		High/Low	V2 Starting Polarity for VTP2 (0 = LO, 1 = HI)	
V3STARTPOL2	1	Sys_Reg(6)		High/Low	V3 Starting Polarity for VTP2 (0 = LO, 1 = HI)	
V4STARTPOL2	1	Sys_Reg(6)		High/Low	V4 Starting Polarity for VTP2 (0 = LO, 1 = HI)	
V1TOG1POS2	9	Sys_Reg(6)	V Counter	0-511	V1 Toggle Position 1 for VTP2	
V1TOG2POS2	9	Sys_Reg(7)	V Counter	0-511	V1 Toggle Position 2 for VTP2	
V2TOG1POS2	9	Sys_Reg(7)	V Counter	0-511	V2 Toggle Position 1 for VTP2	
V2TOG2POS2	9	Sys_Reg(7)	V Counter	0-511	V2 Toggle Position 2 for VTP2	
V3TOG1POS2	9	Sys_Reg(7 and 8)	V Counter	0-511	V3 Toggle Position 1 for VTP2	
V3TOG2POS2	9	Sys_Reg(8)	V Counter	0-511	V3 Toggle Position 2 for VTP2	
V4TOG1POS2	9	Sys_Reg(8)	V Counter	0-511	V4 Toggle Position 1 for VTP2	
V4TOG2POS2	9	Sys_Reg(8)	V Counter	0-511	V4 Toggle Position 2 for VTP2	
VTPLEN3	9	Sys_Reg(9)	V Counter	0-512	Length between Repetitions	
V1STARTPOL3	1	Sys_Reg(9)		High/Low	V1 Starting Polarity for VTP3 (0 = LO, 1 = HI)	
V2STARTPOL3	1	Sys_Reg(9)		High/Low	V1 Starting Polarity for VTP3 (0 = LO, 1 = HI)	
V3STARTPOL3	1	Sys_Reg(9)		High/Low	V1 Starting Polarity for VTP3 (0 = LO, 1 = HI)	
V4STARTPOL3	1	Sys_Reg(9)		High/Low	V1 Starting Polarity for VTP3 (0 = LO, 1 = HI)	
V1TOG1POS3	9	Sys_Reg(9)	V Counter	0-511	V1 Toggle Position 1 for VTP3	
V1TOG2POS3	9	Sys_Reg(9)	V Counter	0-511	V1 Toggle Position 2 for VTP3	
V2TOG1POS3	9	Sys_Reg(9 and 10)	V Counter	0-511	V2 Toggle Position 1 for VTP3	
V2TOG2POS3	9	Sys_Reg(10)	V Counter	0-511	V2 Toggle Position 2 for VTP3	
V3TOG1POS3	9	Sys_Reg(10)	V Counter	0-511	V3 Toggle Position 1 for VTP3	
V3TOG2POS3	9	Sys_Reg(10 and 11)	V Counter	0-511	V3 Toggle Position 2 for VTP3	
V4TOG1POS3	9	Sys_Reg(11)	V Counter	0-511	V4 Toggle Position 1 for VTP3	
V4TOG2POS3	9	Sys_Reg(11)	V Counter	0-511	V4 Toggle Position 2 for VTP3	

Table XVI. Mode_A and Mode_B Registers for VTPx Selection

Register Name	Bit Width	Register Type	Range	Description
VTPSEQPTR0*	3	Mode_Reg(2)		Vertical Transfer Pulse Pointer Used in CCD Region 0 (0 = VTPSEL0, 1 = VTPSEL1, 2 = VTPSEL2, 3 = VTPSEL3 4 = VTPSEL0 for EVEN Line and VTPSEL1 for ODD Line 5 = VTPSEL2 for EVEN Line and VTPSEL3 for ODD Line)
VTPSEQPTR1*	3	Mode_Reg(2)		Vertical Transfer Pulse Pointer Used in CCD Region 1 (0 = VTPSEL0, 1 = VTPSEL1, 2 = VTPSEL2, 3 = VTPSEL3 4 = VTPSEL0 for EVEN Line and VTPSEL1 for ODD Line 5 = VTPSEL2 for EVEN Line and VTPSEL3 for ODD Line)
VTPSEQPTR2*	3	Mode_Reg(2)		Vertical Transfer Pulse Pointer Used in CCD Region 2 (0 = VTPSEL0, 1 = VTPSEL1, 2 = VTPSEL2, 3 = VTPSEL3 4 = VTPSEL0 for EVEN Line and VTPSEL1 for ODD Line 5 = VTPSEL2 for EVEN Line and VTPSEL3 for ODD Line)
VTPSEQPTR3*	3	Mode_Reg(2)		Vertical Transfer Pulse Pointer Used in CCD Region 3 (0 = VTPSEL0, 1 = VTPSEL1, 2 = VTPSEL2, 3 = VTPSEL3 4 = VTPSEL0 for EVEN Line and VTPSEL1 for ODD Line 5 = VTPSEL2 for EVEN Line and VTPSEL3 for ODD Line)
VTPSEQPTR4*	3	Mode_Reg(2)		Vertical Transfer Pulse Pointer Used in CCD Region 4 (0 = VTPSEL0, 1 = VTPSEL1, 2 = VTPSEL2, 3 = VTPSEL3 4 = VTPSEL0 for EVEN Line and VTPSEL1 for ODD Line 5 = VTPSEL2 for EVEN Line and VTPSEL3 for ODD Line)
VTPSEL0	2	Mode_Reg(3)		(0 = VTP0, 1 = VTP1, 2 = VTP2, 3 = VTP3)
VTPSEL1	2	Mode_Reg(3)		(0 = VTP0, 1 = VTP1, 2 = VTP2, 3 = VTP3)
VTPSEL2	2	Mode_Reg(3)		(0 = VTP0, 1 = VTP1, 2 = VTP2, 3 = VTP3)
VTPSEL3	2	Mode_Reg(3)		(0 = VTP0, 1 = VTP1, 2 = VTP2, 3 = VTP3)
VTPREP0	3	Mode_Reg(3)	0-7	Number of VTP0 Pulse Repetitions within a Line
VTPREP1	3	Mode_Reg(4)	0-7	Number of VTP1 Pulse Repetitions within a Line
VTPREP2	3	Mode_Reg(4)	0-7	Number of VTP2 Pulse Repetitions within a Line
VTPREP3	3	Mode_Reg(4)	0-7	Number of VTP3 Pulse Repetitions within a Line

*Registers 6 and 7 are not used.

Table XVII. Mode_A and Mode_B Registers for CCD Region Selection

Register Name	Bit Width	Register Type	Range	Description
SCP1	8	Mode_Reg(2)	0-255 lines	Sequence Change Position 1
SCP2	8	Mode_Reg(3)	0-255 lines	Sequence Change Position 2
SCP3	8	Mode_Reg(3)	0-255 lines	Sequence Change Position 3
SCP4	8	Mode_Reg(3)	0-255 lines	Sequence Change Position 4

AD9898

Special Vertical Sweep Mode Operation

The AD9898 contains a special mode of vertical timing operation called sweep mode. This mode is used to generate a continuous number of repetitive vertical pulses that span multiple HD lines. One example of when this mode may be needed is the start of the CCD readout operation. At the end of the image exposure, but before the image is transferred by the sensor gate pulses, the vertical interline CCD registers should be cleared of all charge. The charge can be shifted out quickly with a long series of pulses on the V1–V4 outputs. This operation will span multiple HD line lengths.

Normally the sequences are contained within one HD line length, but with the sweep mode enabled, the HD boundaries will be ignored until the region is finished. The special vertical sweep mode operation is only output in CCD Region0 and CCD Region3. (See Figures 33 and 34.) The SVREP_MODE register located at control Address 0x0A is used to enable and configure the special sweep mode operation as described in Table XVIII. The maximum number of repeats in each region is 2048 while operating in this mode using the SVREP0 and SVREP3 Mode_Reg(4) registers.

Table XVIII. Description of SVREP_MODE Register

SVREP_MODE	Description of Sweep Mode Operation
0 0	Normal Vertical Timing Operation in All CCD Regions
0 1	Special Vertical Sweep Mode Timing Output in CCD Region0 Only
1 0	Special Vertical Sweep Mode Timing Output in CCD Region3 Only
1 1	Special Vertical Sweep Mode Timing Output in CCD Region0 and CCD Region3

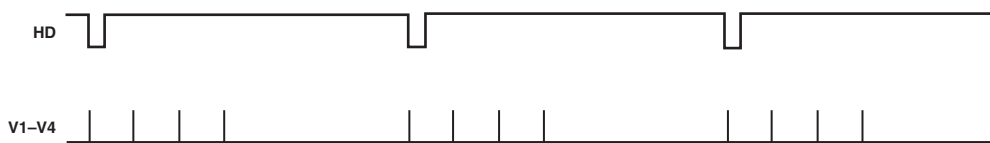

Figure 31. NonOverlapping Example for Normal Vertical Timing Operation with SVREP_MODE = 0 and VTPREPx = 4

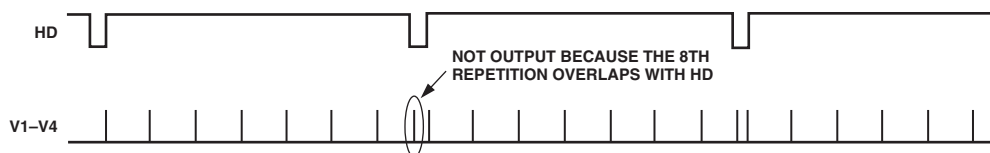

Figure 32. Overlapping Example for Normal Vertical Timing Operation with SVREP_MODE = 0 and VTPREPx = 8

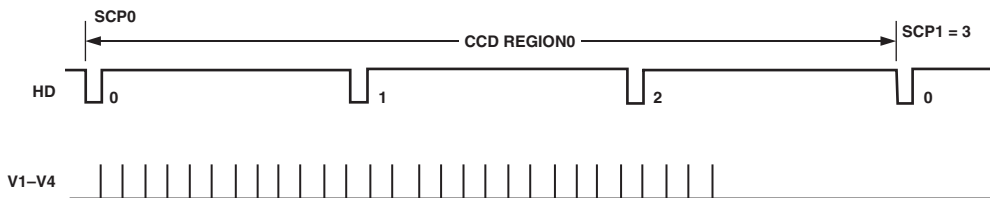

Figure 33. Sweep Mode Timing Example with SVREP_MODE = 1 and SVREP0 = 28

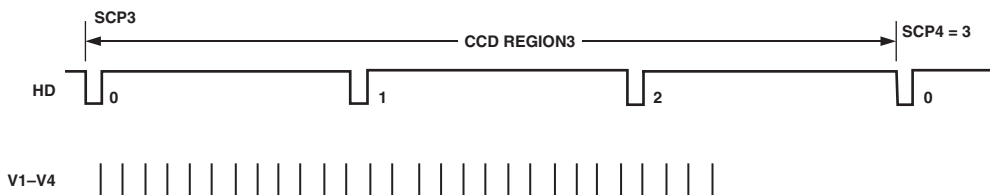

Figure 34. Sweep Mode Timing Example with SVREP_MODE = 2 and SVREP3 = 28

Table XIX. HD and VD Registers

Register Name	Bit Width	Register Type	Reference Counter	Range Pixels	Description
SPAT_EN	1	Control (Addr 0x0A)			SPAT Enable Control (0 = SPAT Disabled, 1 = SPAT Enabled)
SPATLOGIC	4	Control (Addr 0x0A)			SPAT Logic Setting
V1SPAT_TOG1	13	Mode_Reg(5)	ST	0-8192	Polarity Change Position Start for V1 SPAT
V1SPAT_TOG2	13	Mode_Reg(5)	ST	0-8192	Polarity Change Position End for V1 SPAT
V2SPAT_TOG1	13	Mode_Reg(6)	ST	0-8192	Polarity Change Position Start for V2 SPAT
V2SPAT_TOG2	13	Mode_Reg(6)	ST	0-8192	Polarity Change Position End for V2 SPAT
V3SPAT_TOG1	13	Mode_Reg(6 and 7)	ST	0-8192	Polarity Change Position Start for V3 SPAT
V3SPAT_TOG2	13	Mode_Reg(7)	ST	0-8192	Polarity Change Position End for V3 SPAT
V4SPAT_TOG1	13	Mode_Reg(7)	ST	0-8192	Polarity Change Position Start for V4 SPAT
V4SPAT_TOG2	13	Mode_Reg(7 and 8)	ST	0-8192	Polarity Change Position End for V4 SPAT

Special Vertical Timing (SPAT)

The AD9898 provides additional special vertical timing (SPAT) generation, which is output in the same line as the VSG pulse. The SPAT timing allows for configuring a second vertical output pulse in the VSG line. Tables XIX and XX list the registers used to generate the SPAT timing.

Figures 35 and 36 show how the SPAT timing can be either an AND case or an OR case, depending on the value set in the SPATLOGIC register. As these figures show, the internal SPAT timing for the AND case will start High and then go Low at the first VxSPAT_TOG1 position. In the OR case, the internal

SPAT timing will initially start Low and then toggle High at the first VxSPAT_TOG1 position. This provides the ability to output the second vertical pulse when the internal Vx pulse is in both High and Low states.

Table XX. SPATLOGIC Register (Addr 0x0A)

SPATLOGIC [3:0]				Description
3	2	1	0	0 = OR, 1 = AND
V4	V3	V2	V1	

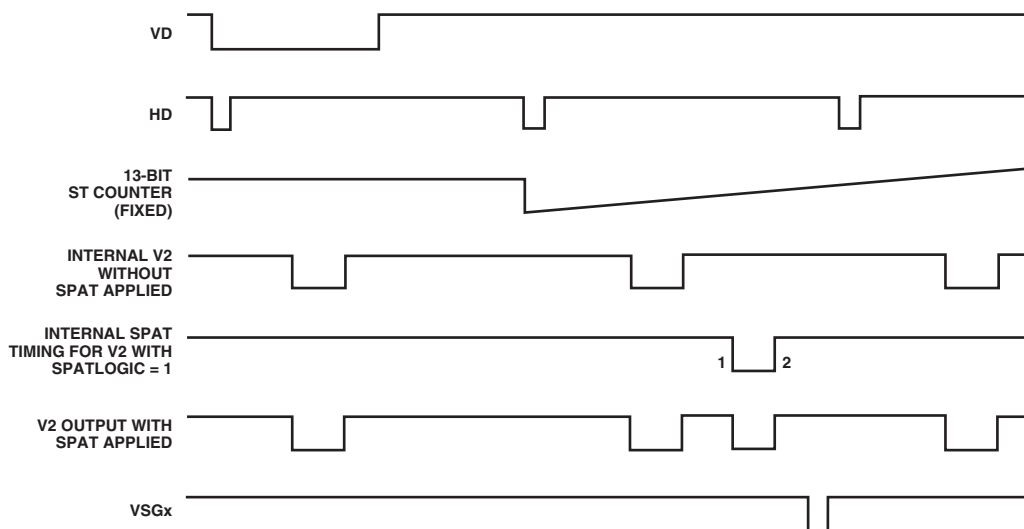

1. THE VxSPAT_TOG1 AND VxSPAT_TOG2 REGISTERS REFERENCE THE 13-BIT ST COUNTER.
2. THE INTERNAL SPAT TIMING IS APPLIED IN THE SAME LINE AS THE VSGx PULSE.

- PROGRAMMABLE CLOCK POSITIONS
1. VxSPAT_TOG1 (PROGRAMMABLE AT MODE_REGS).
 2. VxSPAT_TOG2 (PROGRAMMABLE AT MODE_REGS).

Figure 35. SPAT Example Applied to V2 with SPATLOGIC = xx1x

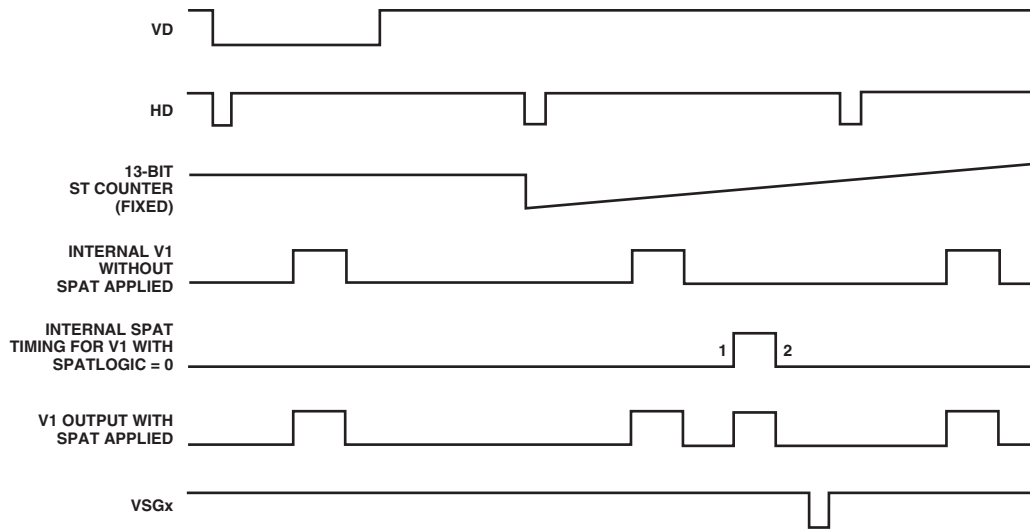

1. THE VxSPAT_TOG1 AND VxSPAT_TOG2 REGISTERS REFERENCE THE 13-BIT ST COUNTER.
2. THE INTERNAL SPAT TIMING IS APPLIED IN THE SAME LINE AS THE VSGx PULSE.

PROGRAMMABLE CLOCK POSITIONS

1. VxSPAT_TOG1 (PROGRAMMABLE AT MODE_REGS).
2. VxSPAT_TOG2 (PROGRAMMABLE AT MODE_REGS).

Figure 36. SPAT Example Applied to V1 with SPATLOGIC = xxx0

Table XXI. SUBCK Registers

Register Name	Bit Width	Register Type	Reference Counter	Range	Description
SUBCKNUM	11	Control (Addr 0x0B)		0–2047 Pulses	Number of SUBCK Pulses per Field
SUBCKSUPPRESS	1	Control (Addr 0x01)		0–1 Pulse	Suppress First SUBCK after Last VSG Line Pulse
SUBCK_EN	1	Control (Addr 0x0B)			SUBCK Output Enable Control (0 = Disable, 1 = Enable)
SUBCKMODE_HP	1	Control (Addr 0x01)			High Speed Shutter Mode Operation
SUBCKNUM_HP	3	Control (Addr 0x0B)		0–7 Pulses	High Speed Shutter SUBCLK Position/Number
SUBCK1TOG1	9	System_Reg(14)	OL-Counter	0–511 Pixel Location	SUBCLK1 First Toggle Position
SUBCK1TOG2	9	System_Reg(14)	OL-Counter	0–511 Pixel Location	SUBCLK1 Second Toggle Position
SUBCK2TOG1	9	System_Reg(15)	OL-Counter	0–511 Pixel Location	SUBCLK2 First Toggle Position
SUBCK2TOG2	9	System_Reg(15)	OL-Counter	0–511 Pixel Location	SUBCLK2 Second Toggle Position
SUBCKSEL	1	Mode_Reg(2)			(0 = SUBCK1, 1 = SUBCK2)

ELECTRONIC SHUTTER TIMING CONTROL

CCD image exposure time is controlled through the use of the CCD substrate clock signal (SUBCK), which pulses the CCD substrate to clear out accumulated charge prior to the exposure period. The AD9898 supports three types of electronic shuttering: normal shutter mode, suppression shutter mode, and high speed shutter mode. Table XXI contains the registers required for programming SUBCK pulses for each of these modes.

Normal Shutter Mode

Figure 37 shows the VD and SUBCK output for normal shutter mode. The SUBCK will pulse once per line. The number of SUBCK pulses per field can be programmed by setting register SUBCKNUM (Addr 0x0B). As shown in Figure 37, the SUBCK pulses will always begin on the line after the sensor gate occurs, specified by VSGACTLINE (Mode_Reg(1)).

SUBCK Suppression Mode

Normally the SUBCKs will begin to pulse on the line following the last sensor gate line (VSG). With some CCDs, the first SUBCK following the VSG line needs to be suppressed. The SUBCKSUPPRESS register allows for this suppression. The first SUBCK following the last VSG pulse is suppressed when SUBCKSUPPRESS = 1, as shown in Figure 38.

High Precision Shutter Mode

The high speed shutter mode can be operated in two different modes, single pulse and multiple pulse. These modes are set up by programming the SUBCKNUM_HP register and SUBCKMODE_HP register, as described in Table XXII and shown in Figures 40 and 41.

Single Pulse Mode

In addition to the normal operating SUBCK pulse, one additional SUBCK pulse can be applied within the HD line while

operating in this mode. As shown in Figure 37, the location of the additional SUBCK pulse is adjusted by setting the SUBCKNUM_HP register as described in Table XXII. Finer resolution of the exposure time is possible using this mode by adding a SUBCK pulse in the line, as shown in Figure 40.

Multiple Pulse Mode

In addition to the normal operating SUBCK pulse, up to seven sequential SUBCK pulses can be applied within the same line while operating in this mode. As shown in Figure 41, the number of additional SUBCK pulses is selectable by setting SUBCKMODE_HP = 1 and the SUBCKNUM_HP registers as described in Table XXII.

Table XXII. Single and Multiple Pulse Mode

SUBCKNUM_HP	SUBCKMODE_HP	
	0	1
	Single Pulse Mode	Multiple Pulse Mode
0	Normal Shutter Mode Operation	Normal Shutter Mode Operation
1	Position No. 1	1 Additional Pulse
2	Position No. 2	2 Additional Pulses
3	Position No. 3	3 Additional Pulses
4	Position No. 4	4 Additional Pulses
5	Position No. 5	5 Additional Pulses
6	Position No. 6	6 Additional Pulses
7	Position No. 7	7 Additional Pulses

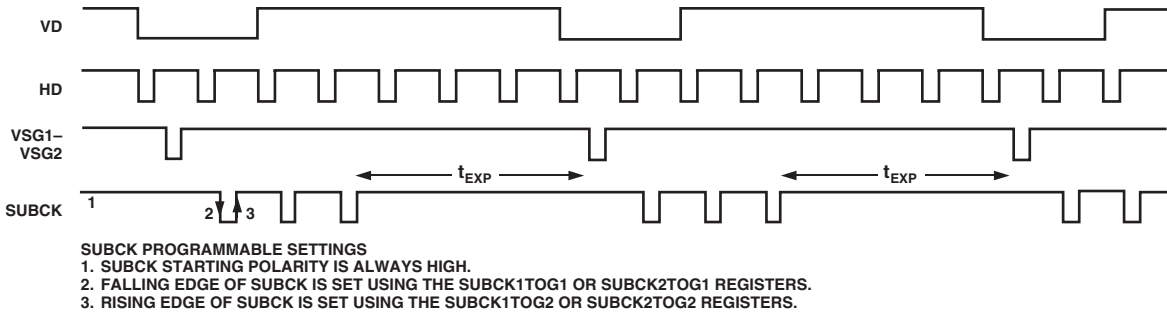

NUMBER OF SUBCK PULSES WITHIN THE FIELD IS SET USING THE SUBCKNUM REGISTER. IN THIS EXAMPLE, SUBCKNUM = 2.

Figure 37. Normal Shutter Mode

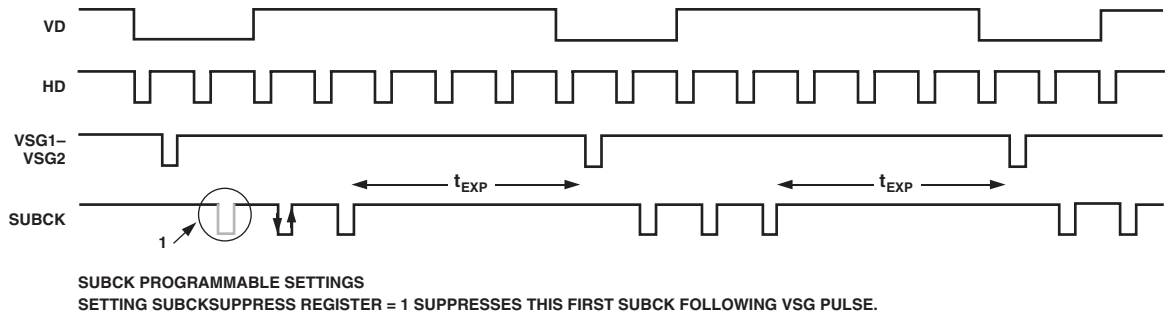

Figure 38. SUBCK Suppression Mode

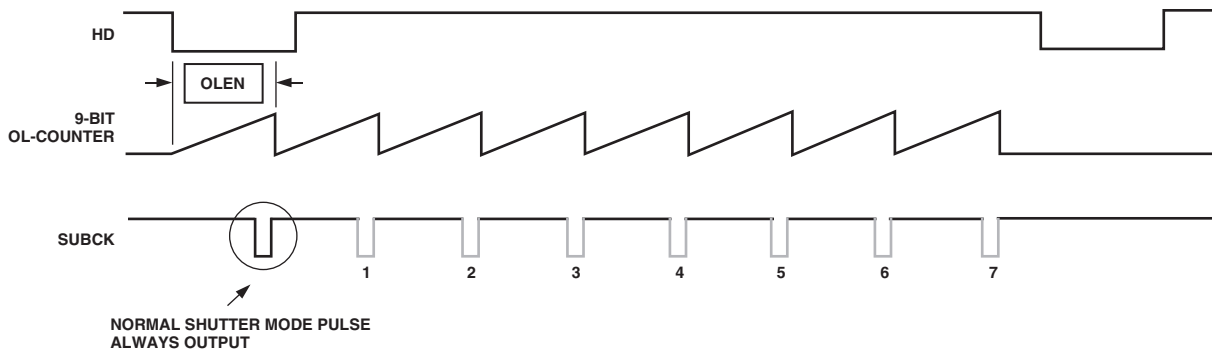

Figure 39. Electronic Shutter Timing

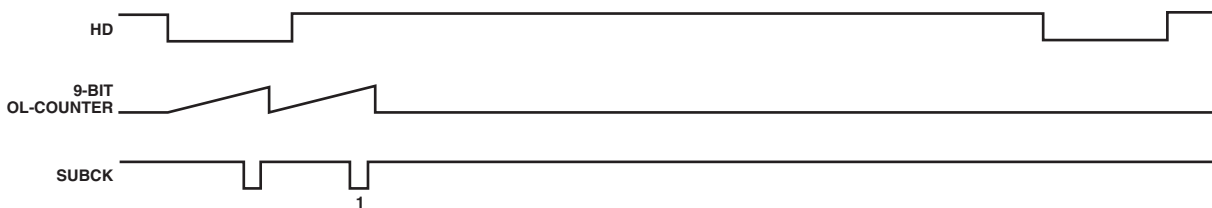

Figure 40. Electronic Shutter Timing Example with $SUBCKMODE_HP = 0$ and $SUBCKNUM_HP = 1$

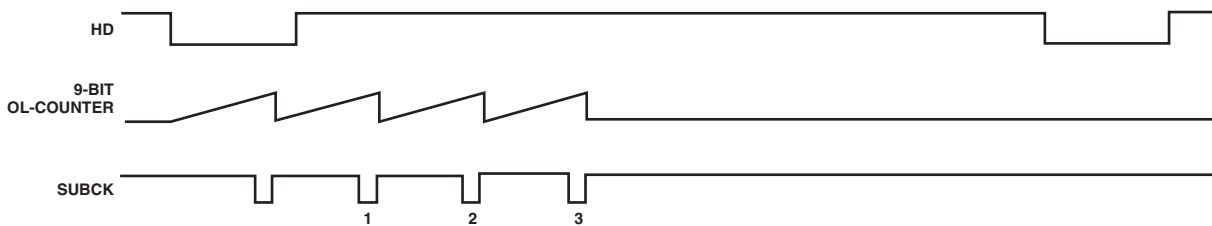

Figure 41. Electronic Shutter Timing Example with $SUBCKMODE_HP = 1$ and $SUBCKNUM_HP = 3$

AD9898

VSG TIMING

The VSG timing is controlled using the registers in Table XXIII. Two unique preprogrammed VSG pulses can be configured using the VSGTOG1_x (x = 0, 1) registers. As shown in Figure 42, the period of the VSG pulse is set by programming the VSGLEN register. The VSGSELx (x = 0, 1) can then be used to point to either the VSGTOG1_0 or VSGTOG1_1 pulse.

Figure 42 also shows an example of the VSG pulse being output in the fourth line by setting the VSGACTLINE = 3. The VSG1 and VSG2 pulses reference the 13-bit fixed ST counter, which starts counting from the line set in the VSGACTLINE register. The 13-bit counter allows for overlapping of the VSG pulse into the next line, if needed.

Table XXIII. VSG Registers

Register Name	Bit Width	Register Type	Reference Counter	Range	Description
VSGMASK	6	Control (Addr 0x0A)			VSG Mask Control (00 = VSG1 masked, VSG2 masked) (02 = VSG1 not masked, VSG2 masked) (08 = VSG1 masked, VSG2 not masked) (0A = VSG1 not masked, VSG2 not masked)
VSG_EN	1	Control (Addr 0x0B)		High/Low	VSG Output Enable Control (0 = Disable VSG Outputs, 1 = Enable VSG Outputs)
VSGTOG1_0	11	Sys_Reg(13)	ST	0–8191 Pixels	VSG Sequence 1, Toggle Position 1
VSGTOG1_1	11	Sys_Reg(13)	ST	0–8191 Pixels	VSG Sequence 2, Toggle Position 1
VSGLEN	8	Sys_Reg(14)	ST	0–255 Pixels	VSG Pulsewidth
VSGSEL0	1	Mode_Reg(1)		High/Low	VSG1 Output Selector (0 = VSGTOG1_0 applied on VSG1 output, 1 = VSGTOG1_1 applied on VSG1 output)
VSGSEL1	1	Mode_Reg(1)		High/Low	VSG2 Output Selector (0 = VSGTOG1_0 applied on VSG2 output, 1 = VSGTOG1_1 applied on VSG2 output)
VSGACTLINE	7	Mode_Reg(1)		0–128 Lines	VSG Active Line

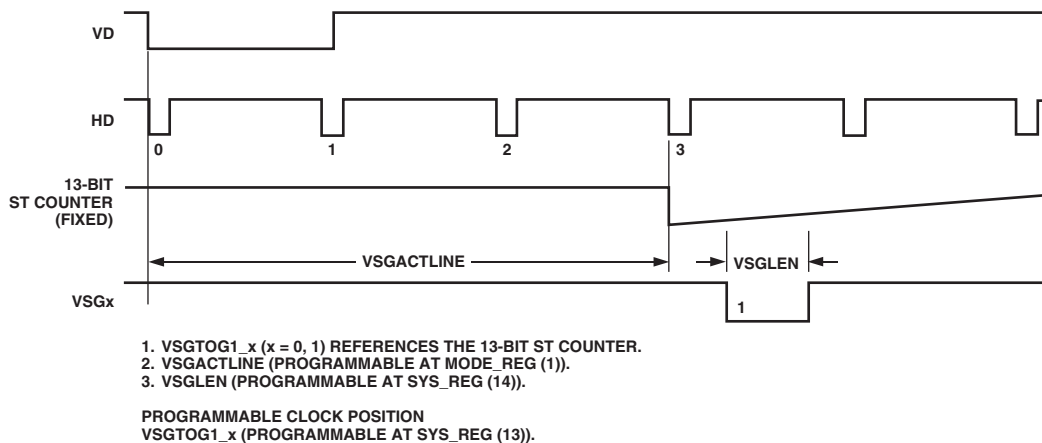

Figure 42. Example of VSG Pulse

VSUB CONTROL

The CCD readout bias (VSUB) can be programmed to accommodate different CCDs. VSUB ON and OFF toggle positions and polarity are controlled using VSUBTOG (Addr 0x0D) and VSUBPOL (Addr 0x0E) registers, respectively, as described in Table XXIV. Since the VSUBTOG is an 11-bit register, the VSUB ON position is programmable within any line. Figure 43 shows an example of controlling VSUB using these registers.

Table XXIV. VSUB Registers

Register Name	Bit Width	Register Type	Range (Lines)	Description
VSUBPOL	1	Control		(0 = Low, 1 = High)
VSUBTOG	11	Control	0-2048	VSUB Toggle Position

VSUB Placement and Polarity

Figure 43 shows the sequence of events for programming the VSUB ON and OFF toggle positions and polarity.

1. Program VSUBTOG = 2 and VSUBPOL = 1.
2. Since VSUBTOG and VSUBPOL are VD synchronous type registers, the falling edge of VD will update the serial writes from Step 1 here.
3. VSUB will be asserted high after two HD cycles.
4. Program VSUBTOG = 3 and VSUBPOL = 0.
5. Since VSUBTOG and VSUBPOL are VD synchronous type registers, the falling edge of VD will update the serial writes from Step 4 here.
6. VSUB will be asserted low after three HD cycles.

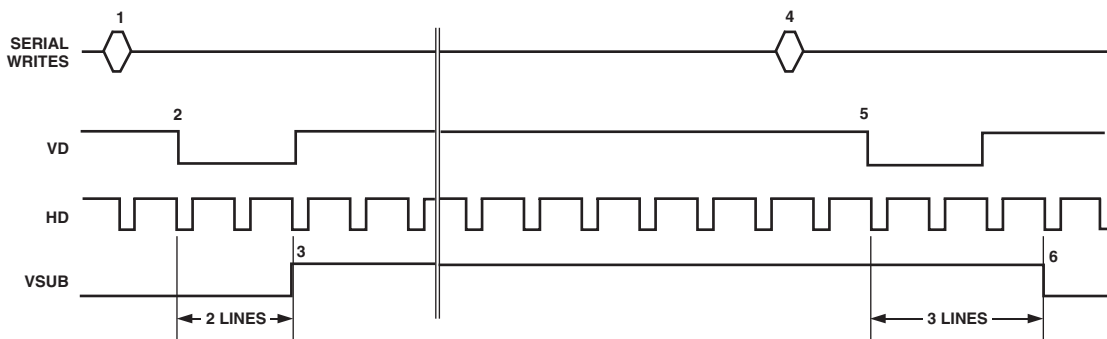

Figure 43. VSUB Timing Example

AD9898

MSHUT CONTROL

MSHUT Basic Operation

The AD9898 provides an MSHUT output pulse that can be configured to control the mechanical shutter of the camera. The registers used to control the MSHUT pulse are listed in Table XXV.

The MSHUT pulse can be placed at the start of any line by using the 11-bit MSHUTPOS register. The MSHUT pulsewidth is controlled using the MSHUTLEN register.

The AD9898 offers four preprogrammed MSHUT patterns that are selectable using the MSHUTPAT register. The preprogrammed length is the same for all patterns set by the MSHUTLEN register, but the active ON period of the MSHUT pulse is different for each pattern, as shown in Figure 44. Figure 45 shows an example of selecting MSHUTPAT0 positioned to start three lines after the falling edge of VD with MSHUTLEN = 5.

Table XXV. MSHUT and STROBE Registers

Register Name	Bit Width	Register Type	Description
MSHUTPAT	2	Control (Addr 0x01)	Selects MSHUT Pattern (See Figure 44) (0 = MSHUTPAT0, 1 = MSHUTPAT1, 2 = MSHUTPAT2, 3 = MSHUTPAT3)
MSHUTINIT	1	Control (Addr 0x0C)	MSHUT Initialize (1 = MSHUT Output Held LOW, 0 = Normal Operation Resumes)
MSHUTEN	1	Control (Addr 0x0C)	MSHUT Control (0 = MSHUT Held at Last State, 1 = MSHUT Output Enabled for Normal Operation)
MSHUTPOS	11	Control (Addr 0x0C)	MSHUT Position during Normal Operation
MSHUTPOS_HP	3	Control (Addr 0x0C)	MSHUT Position during High Precision Operation
MSHUTLEN	8	Sys_Reg(13)	MSHUT Pattern Length (See Figures 44 and 45)
STROBE_EN	1	Control (Addr 0x0B)	STROBE Output Enable Control (0 = STROBE Output Held Low, 1 = Enable STROBE Output)

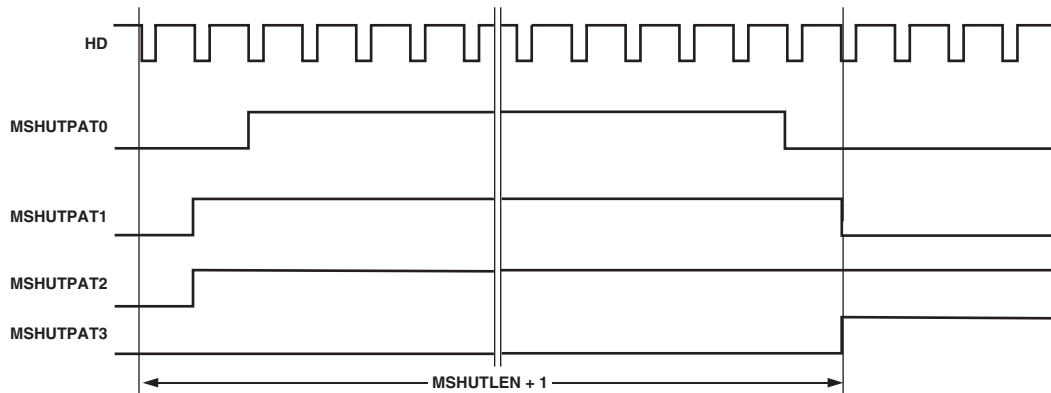

Figure 44. MSHUT Patterns Available by Setting MSHUTPAT Register

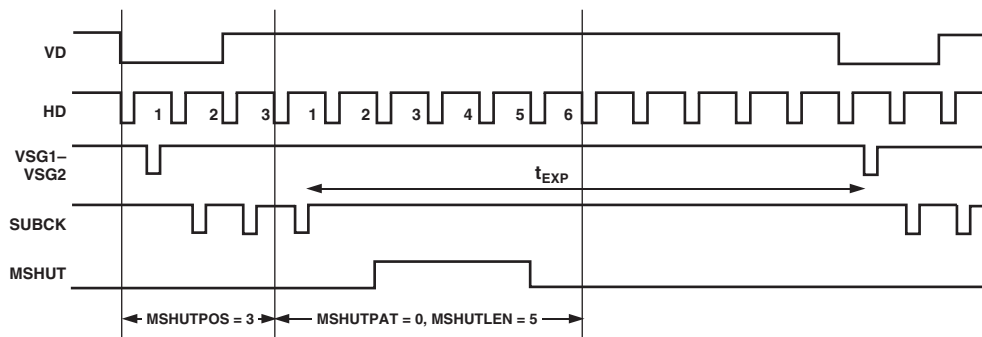

Figure 45. Example of MSHUT Timing with MSHUTEN = 1 and MSHUTPOS_HP = 0

MSHUT High Precision Operation

The MSHUTPOS_HP register allows more precise control of the MSHUT position within a line. Under normal MSHUT operation when MSHUTPOS_HP = 0, the MSHUT polarity changes from high to low on the negative edge of the HD pulse, as shown in Figure 44. By using the MSHUTPOS_HP register, the rising and falling edges of MSHUT can be delayed by multiples of the OL counter length, which has been set in the OLEN

register. For example, if MSHUTPOS_HP = 3, the MSHUT rising and falling edges will be delayed by three OL counter cycles after the falling edge of HD, as shown in Figure 46.

Figure 46 provides an example of high precision MSHUT and SUBCK timing. In this example, the length of the OL counter is shorter. This provides very precise control of the placement of the MSHUT pulse within a line.

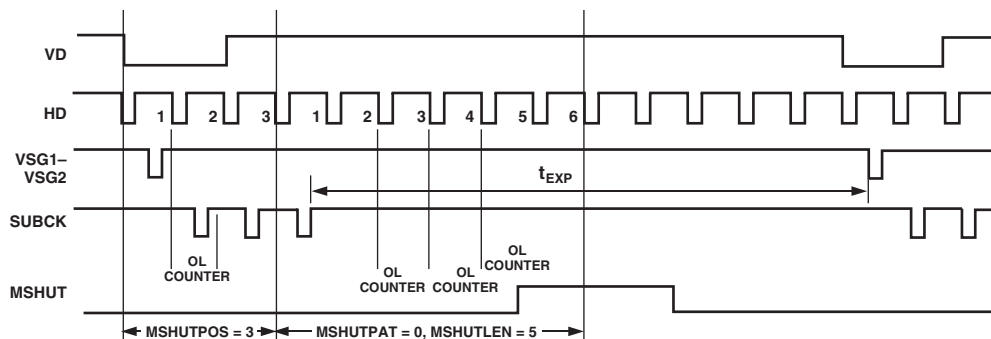
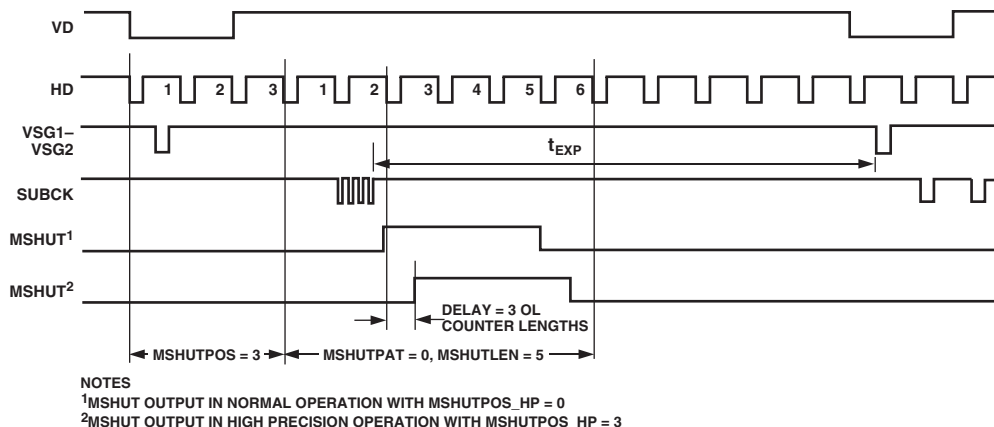

Figure 46. Example of MSHUT High Precision Timing—MSHUTEN = 1 and MSHUTPOS_HP = 3



NOTES
¹MSHUT OUTPUT IN NORMAL OPERATION WITH MSHUTPOS_HP = 0
²MSHUT OUTPUT IN HIGH PRECISION OPERATION WITH MSHUTPOS_HP = 3

Figure 47. Example of MSHUT High Precision Timing—MSHUTEN = 1, MSHUTPOS_HP = 3, with SUBCKMODE_HP = 1, SUBCKNUM_HP = 3

AD9898

STROBE Control

The AD9898 provides a STROBE output pulse that can be used to trigger the camera flash circuit. STROBE operation is set by only one register, as described in Table XXV. The STROBE output is held Low when STROBE_EN (Addr 0x0B) is set to 0 and enabled when set to 1. Providing STROBE_EN = 1, the STROBE output pulse will be asserted High on the rising edge of the last SUBCK pulse in the field, as shown in Figure 48. Figure 48 also shows the STROBE pulse asserted Low again on the rising edge of VSG.

SLAVE AND MASTER MODE OPERATION

The AD9898 can be operated in either slave mode or master mode. It defaults to the slave mode operation at power-up. The

SLAVE_MODE register (Addr 0xD6) can be used to configure the AD9898 into master mode by setting SLAVE_MODE = 0.

Slave Mode Operation

While operating in slave mode, VD, HD, and VGATE are provided externally from the image processor. VGATE is input active high on Pin 45. Unlike master mode operation, there is a 7 CLI clock cycle delay from the falling edge of HD to when the 12-bit gray code H counter is reset to zero (see Figure 49).

Master Mode Operation

While operating in master mode, VD and HD are outputs and the SYNC/VGATE pin is configured as an external SYNC input. Master mode is selected by setting register SLAVE_MODE (Addr 0xD6) = 0.

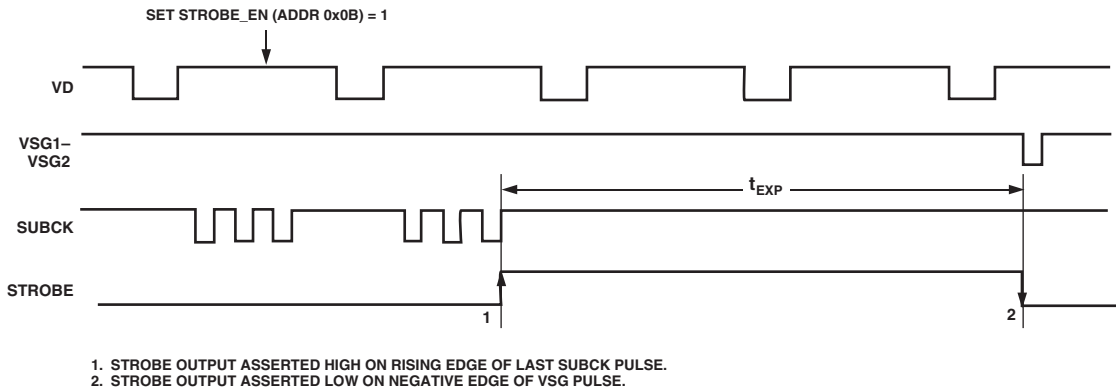

Figure 48. STROBE Output Timing

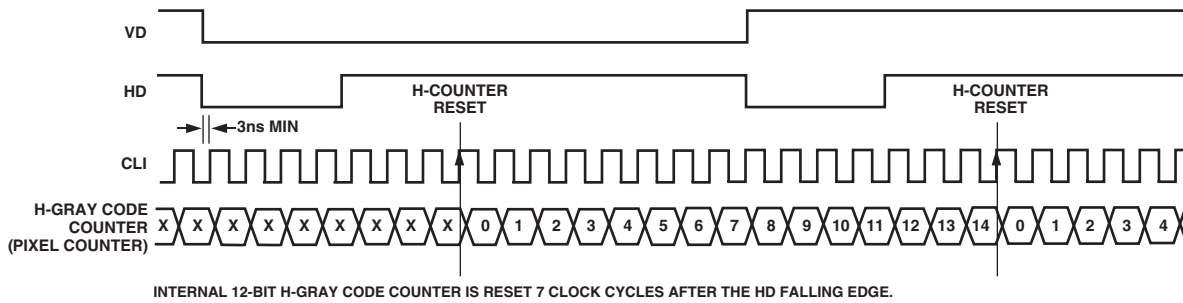

Figure 49. External VD/HD and Internal 12-Bit H-Gray Code Counter Synchronization, SLAVE Mode

VARIABLE GAIN AMPLIFIER

The VGA provides a gain range of 6 dB to 40 dB, programmable with 10-bit resolution through the serial digital interface. The minimum gain of 6 dB is needed to match a 1 V input signal with the ADC full-scale range of 2 V.

The VGA gain curve follows a linear-in-dB characteristic. The exact VGA gain can be calculated for any gain register value using the equation

$$\text{Gain} = (0.035 \times \text{Code}) + 5.3$$

where the code range is 0 to 1023. Figure 50 shows a typical AD9898 VGA gain curve.

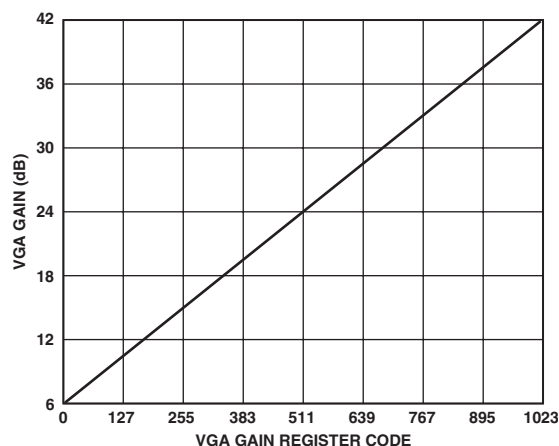

Figure 50. VGA Gain Curve

Optical Black Clamp

The optical black clamp loop is used to remove residual offsets in the signal chain and to track low frequency variations in the CCD's black level. During the optical black (shielded) pixel interval on each line, the ADC output is compared with a fixed black level reference, selected by the user in the clamp level register. Any value between 0 LSB and 63 LSB may be programmed with 6-bit resolution. The resulting error signal is filtered to reduce noise, and the correction value is applied to the ADC input through a D/A converter. Normally the optical black clamp loop is turned on once per horizontal line, but this loop can be updated more slowly to suit a particular application.

The optical black clamp is controlled by the CLPOB signal, which is fully programmable (see Horizontal Clamping and Blanking section). System timing examples are shown in the Horizontal Timing Sequence Example section. The CLPOB pulse should be placed during the CCD's optical black pixel. It is recommended that the CLPOB pulse duration be at least 20 pixels wide. Shorter pulsewidths may be used, but the ability to track low frequency variations in the black level will be reduced.

A/D Converter

The AD9898 uses a high performance 10-bit ADC architecture, optimized for high speed and low power. Differential nonlinearity (DNL) performance is typically better than 0.5 LSB. The ADC uses a 2 V input range. Better noise performance results from using a larger ADC full-scale range.

Digital I/O States for Different Operating Conditions

Table XXVI describes the state of the digital I/Os for different operating conditions.

Table XXVI. I/O Levels

I/O	OCONT_REG ¹ = 0	SW_RESET	DIGSTBY	SYNC
DCLK1	ACTIVE	ACTIVE	L	ACTIVE
DCLK2	ACTIVE	ACTIVE	L	ACTIVE
VD ²	H	H	H	H
HD ²	H	H	H	H
RG	L	L	L	ACTIVE
H1	H	H	H	ACTIVE
H2	L	L	L	ACTIVE
V1	H	L	H	FREEZE
V2	H	L	L	FREEZE
V3	H	L	L	FREEZE
V4	H	H	H	FREEZE
SUBCK	H	H	H	FREEZE
VSG1	H	L	H	FREEZE
VSG2	H	H	H	FREEZE
STROBE	L	L	L	FREEZE
MSHUT	L	L	L	FREEZE
FD	H	L	L	FREEZE

NOTES

¹OCONT_REG is a register setting located at Addr 0x05. It defaults to 0 at power-up.

²VD and HD operating in master mode.

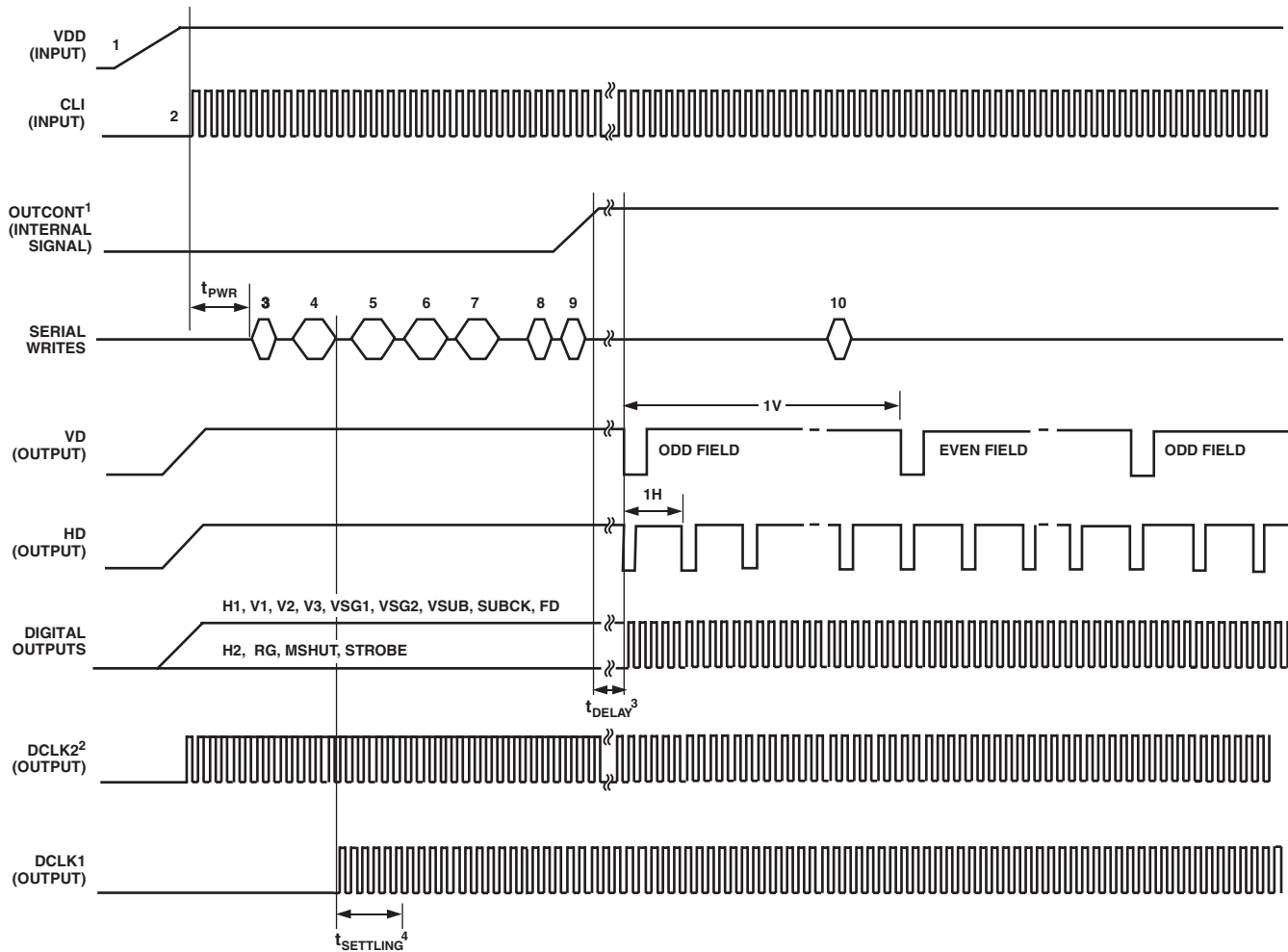

NOTES

- ¹OUTCONT IS AN INTERNAL SIGNAL CONTROLLED USING REGISTER OUTCONT_REG (ADDR 0x05).
- ²DCLK2 WILL BE OUTPUT ON FD/DCLK2, PIN 16, PROVIDING REGISTER DCLK2SEL (ADDR 0xD5) = 1.
- ³IT TAKES 11 CLI CLOCKS FROM WHEN OUTCONT GOES HIGH UNTIL VD, HD, AND DIGITAL OUTPUT DATA IS VALID.
- ⁴THERE IS 500 μ s SETTLING TIME FROM WHEN THE DIGSTBY REGISTER IS SET TO WHEN THE DCLK1 IS STABLE.

Figure 51. Recommended Power-Up Sequence and Synchronization, Master Mode

POWER-UP

Recommended Power-Up Sequence for Master Mode

When the AD9898 is powered up, the following sequence is recommended. (Refer to Figure 51 for each step.)

1. Turn on power supplies for AD9898.
2. Apply the CLI master clock input. CLI will be output on DCLK2 (Pin 16) at this time.
3. Reset the internal AD9898 registers. Write a 0x000000 to the SW_RESET register (Addr 0x00). This will set all internal register values to their default values. (This step is optional because an internal power-on reset circuit is applied at power-up.)
4. Program the DIGSTBY and AFESTBY registers (Addr 0x05) = 1, and program all other necessary control registers.
5. Program system registers (Addr 0x14).
6. Program Mode_A registers (Addr 0x15).
7. Program Mode_B registers (Addr 0x16).
8. Program OUTCONT_REG register (addr 0x05) = 1. (The internal OUTCONT signal will be asserted high at this time and will enable the digital outputs.)
9. Program control register MODE (Addr 0x0A) = 0. This selects Mode_A operation. (This step is optional because the AD9898 defaults to Mode_A at initial power-up.)
10. Program control register MODE (Addr 0x0A) = 1. This selects Mode_B operation. Complete this write at least four CLI cycles before start of the next field.

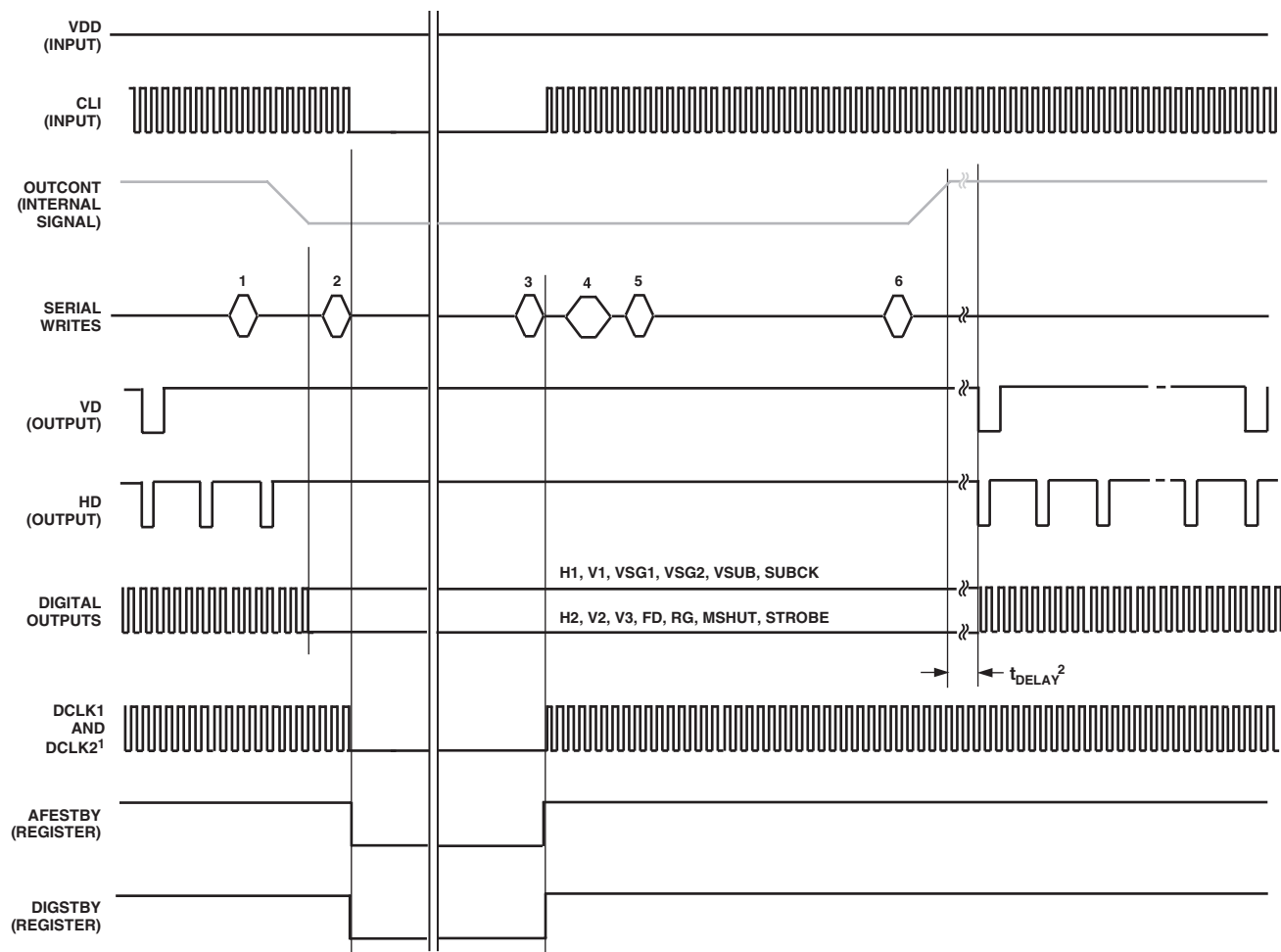

NOTES

¹DCLK2 WILL BE OUTPUT ON FD/DLCK2, PIN 16, PROVIDING REGISTER DCLK2SEL (ADDR 0xD5) = 1.

²IT TAKES 11 CLI CLOCKS FROM WHEN OUTCONT GOES HIGH UNTIL VD, HD, AND DIGITAL OUTPUT DATA IS VALID.

Figure 52. Recommended Standby Sequence

STANDBY MODE OPERATION

Recommended Standby Mode Sequence

When the AD9898 is going into standby operation, the following sequence is recommended. (Refer to Figure 52 for each step.)

1. Program OUTCONT_REG (Addr 0x05) = 0. This will assert the internal OUTCONT signal LO causing all digital outputs to become disabled.
2. Program registers AFESTBY (Addr 0x05) = 0 and DIGSTBY (Addr 0x05) = 0. The AD9898 is then in standby operation.
3. When it is time to come out of standby operation, program register DIGSTBY (Addr 0x05) = 1 and register AFESTBY (Addr 0x05) = 1.
4. Program necessary control registers.
5. Program control register MODE (Addr 0x0A) = 0. This selects Mode_A operation.
6. Program register OUTCONT_REG (Addr 0x05) = 1. This will assert the internal OUTCONT signal high, causing all digital outputs to become active.

AD9898

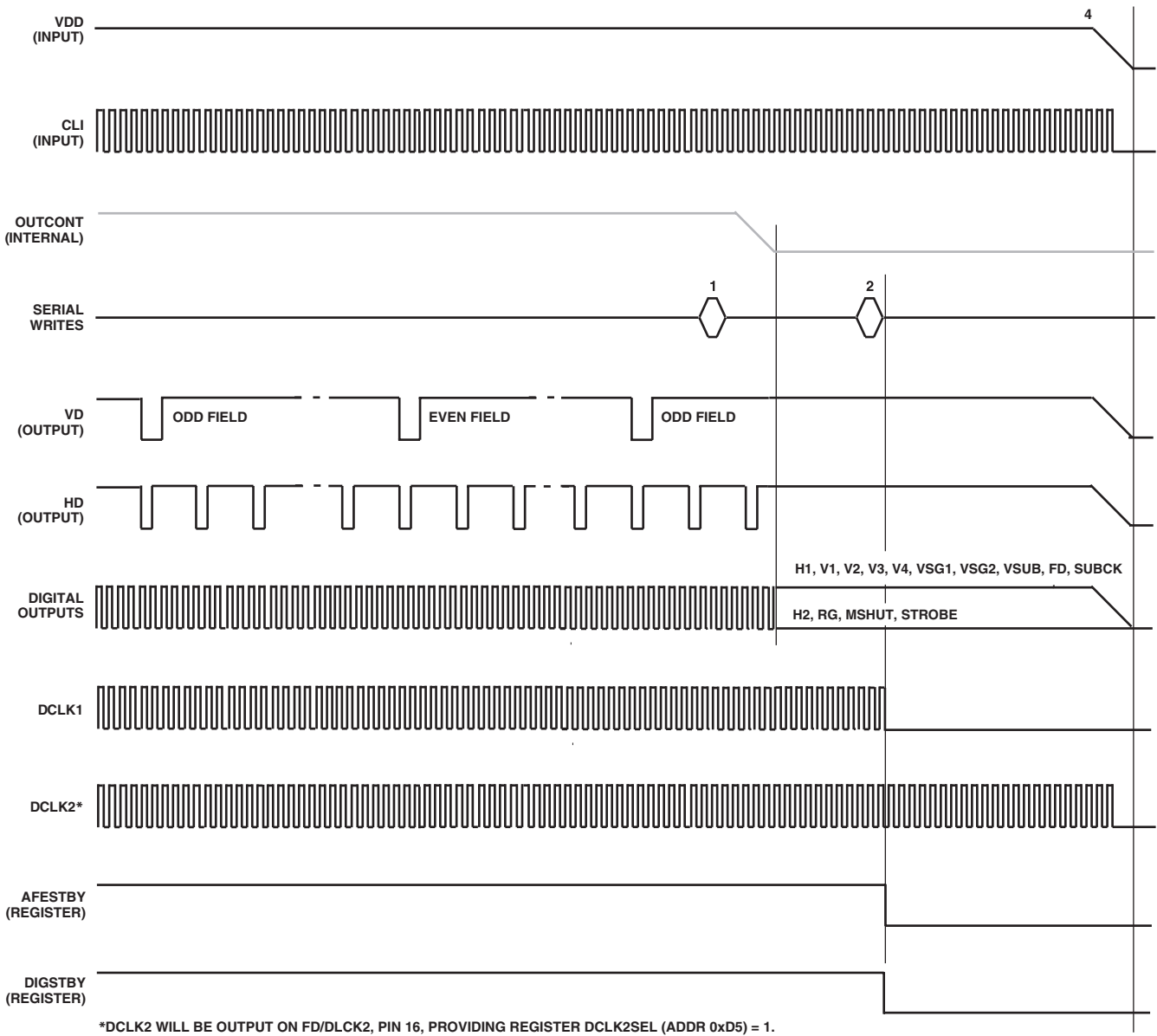

Figure 53. Recommended Power-Down Sequence

POWER-DOWN MODE OPERATION

Recommended Power-Down Sequence

When the AD9898 is going to be powered down, the following sequence is recommended. (Refer to Figure 53 for each step.)

1. Program OUTCONT_REG (Addr 0x05) = 0.
2. Program registers AFESTBY (Addr 0x05) = 0 and DIGSTBY (Addr 0x05) = 0.
3. Remove power from the AD9898.

HORIZONTAL TIMING SEQUENCE EXAMPLE

Figure 54 shows a sample CCD layout. The horizontal register contains 28 dummy pixels, which will occur on each line clocked from the CCD. In the vertical direction, there are 10 optical black (OB) lines at the front of the readout and two at the back. The horizontal direction has four OB pixels in the front and 48 in the back.

To configure the AD9898 horizontal signals for this CCD, three sequences can be used. Figure 55 shows the first sequence to be used during vertical blanking. During this time, there are no

valid OB pixels from the sensor, so the CLPOB is not used. In some cases, if the horizontal clocks are used during this time, the CLPOB signal may be used to keep the AD9898's clamp partially settled.

Figure 56 shows the recommended sequence for the vertical OB interval. The clamp signal is used across the whole line in order to stabilize the clamp loop of the AD9898. Figure 57 shows the recommended sequence for the effective pixel readout. The 48 OB pixels at the end of each line are used for the CLPOB signal.

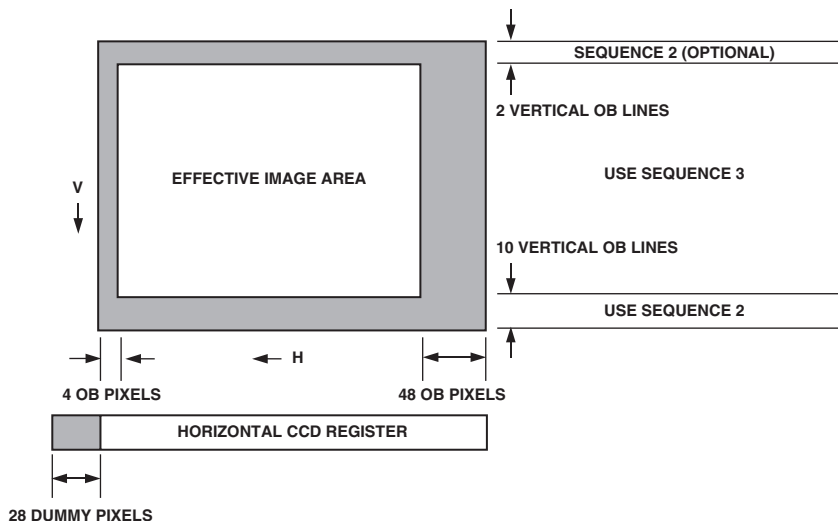
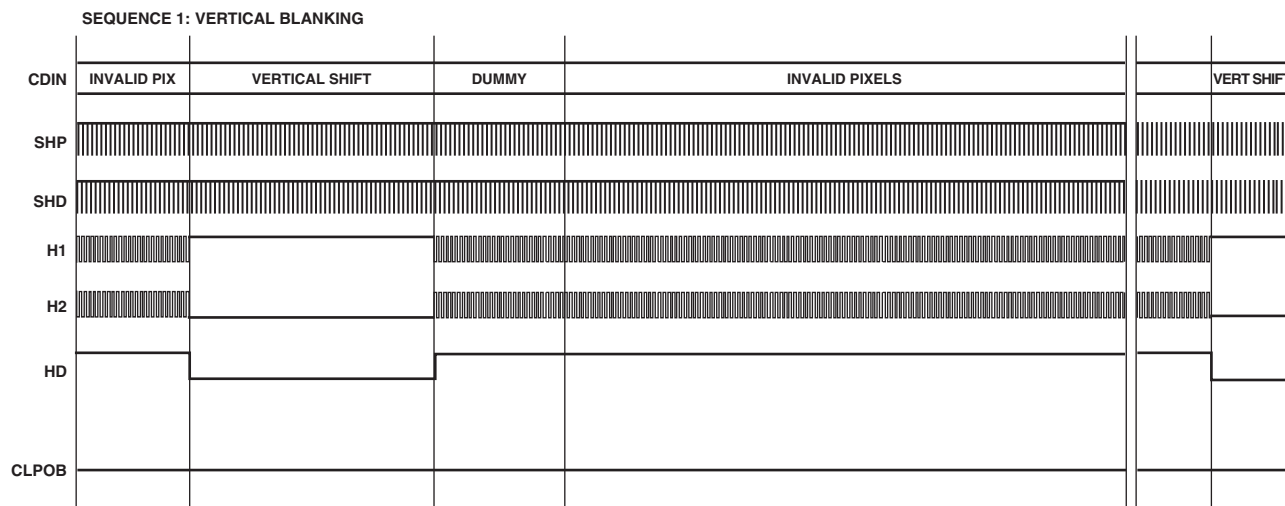

Figure 54. Sample CCD Configuration



CLPOB PULSE MAY BE USED DURING HORIZONTAL DUMMY PIXELS IF THE H-CLOCKS ARE USED DURING VERTICAL BLANKING.

Figure 55. Horizontal Sequence during Vertical Blanking

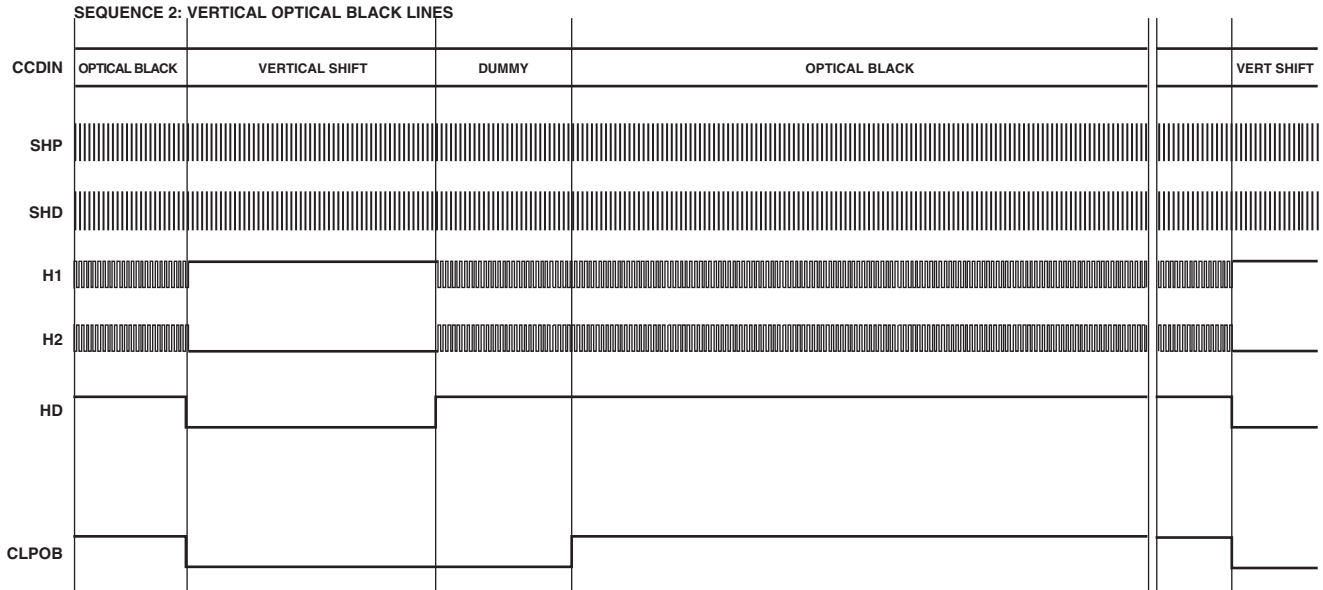

Figure 56. Horizontal Sequence during Vertical Optical Black Pixels

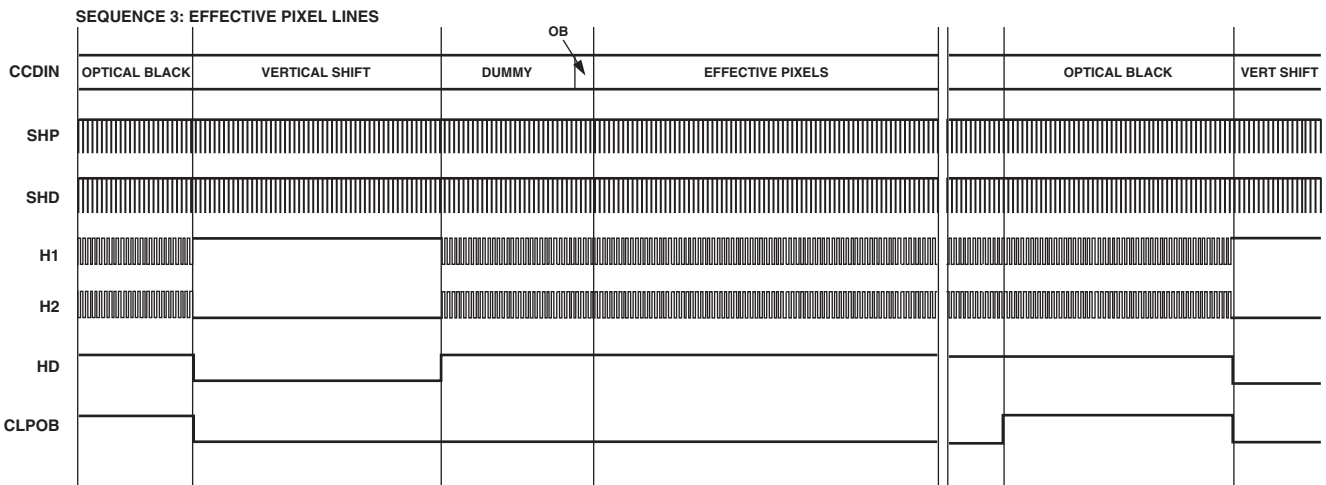

Figure 57. Horizontal Sequences during Effective Pixels

CIRCUIT LAYOUT INFORMATION

The AD9898 typical circuit connection is shown in Figure 58. The PCB layout is critical to achieving good image quality from the AD9898. All of the supply pins, particularly the AVDD, TCVDD, RGVDD, and HVDD supplies, must be decoupled to ground with good quality high frequency chip capacitors. The decoupling capacitors should be located as close as possible to the supply pins and should have a very low impedance path to a continuous ground plane. There should also be a 4.7 μF or larger value bypass capacitor for each main supply—AVDD, RGVDD, HVDD, and DRVDD—although this is not necessary for each individual pin. For most applications, it is easier to share the supply for RGVDD and HVDD, which may be done as long as the individual supply pins are separately bypassed. A separate 3 V supply may also be used for DRVDD, but this

supply pin should still be decoupled to the same ground plane as the rest of the chip. A separate ground for DRVSS is not recommended.

The analog bypass pins (REFB, REFT) also should be carefully decoupled to ground as close as possible to their respective pins. The analog input (CCDIN) capacitor also should be located close to the pin.

The H1, H2, and RG traces should be designed to have low inductance to avoid excessive distortion of the signals. Heavier traces are recommended because of the CCD's large transient current demand on H1 and H2. When possible, physically locating the AD9898 closer to the CCD will reduce the inductance on these lines. As always, the routing path should be as direct as possible from the AD9898 to the CCD.

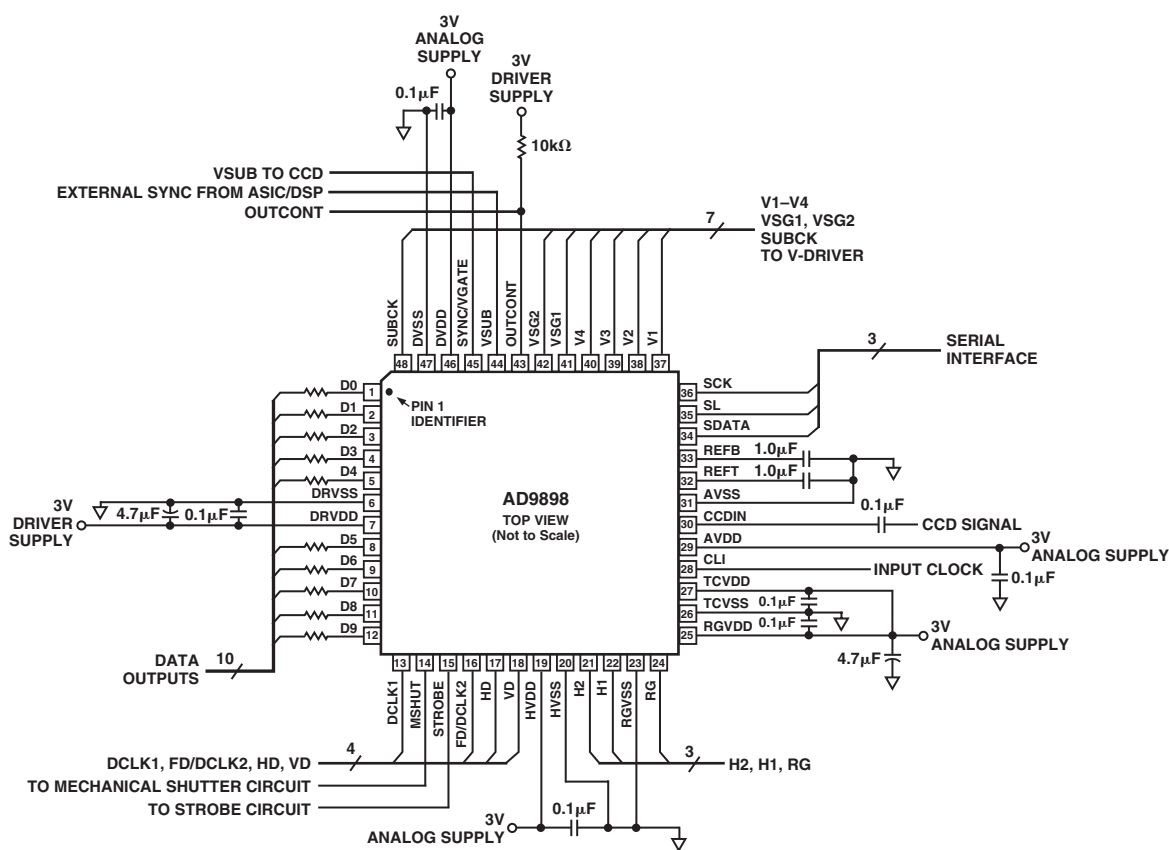

Figure 58. Typical Circuit Configuration

