

# SS12 - S100

## Features

- Glass passivated junctions.
- High current capability, low  $V_F$ .
- For use in low voltage, high frequency inverters free wheeling, and polarity protection applications.

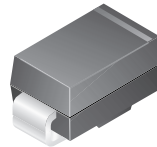

**SMA/DO-214AC**  
COLOR BAND DENOTES CATHODE

## 1.0 Ampere Schottky Barrier Rectifiers

### Absolute Maximum Ratings\* $T_A = 25^\circ\text{C}$ unless otherwise noted

Symbol	Parameter	Value	Units
$I_{F(AV)}$	Average Rectified Current .375" lead length @ $T_A = 75^\circ\text{C}$	1.0	A
$I_{FSM}$	Non-repetitive Peak Forward Surge Current 8.3 ms single half-sine-wave Superimposed on rated load (JEDEC method)	40	A
$P_D$	Total Device Dissipation Derate above $25^\circ\text{C}$	1.1 11	W mW/ $^\circ\text{C}$
$R_{\theta JA}$	Thermal Resistance, Junction to Ambient **	88	$^\circ\text{C}/\text{W}$
$T_{stg}$	Storage Temperature Range	-65 to +150	$^\circ\text{C}$
$T_J$	Operating Junction Temperature	-65 to +125	$^\circ\text{C}$

\*These ratings are limiting values above which the serviceability of any semiconductor device may be impaired.

\*\* Device mounted on FR-4 PCB 0.013 mm.

### Electrical Characteristics $T_A = 25^\circ\text{C}$ unless otherwise noted

Symbol	Parameter	Device								Units
		12	13	14	15	16	18	19	100	
$V_{RRM}$	Maximum Repetitive Reverse Voltage	20	30	40	50	60	80	90	100	V
$V_{RMS}$	Maximum RMS Voltage	14	21	28	35	42	56	64	71	V
$V_R$	DC Reverse Voltage (Rated $V_R$ )	20	30	40	50	60	80	90	100	V
$I_{RM}$	Maximum Instantaneous Reverse Current $T_A = 25^\circ\text{C}$ (Note 1) @ rated $V_R$ $T_A = 100^\circ\text{C}$	0.2 10								mA mA
$V_{FM}$	Maximum Instantaneous Forward Voltage @ 1.0 A	500		700		850			mV	

**Note:** Pulse Test: Pulse Width  $\leq 300 \mu\text{s}$ , Duty Cycle  $\leq 2.0\%$

Typical Characteristics

Forward Current Derating Curve

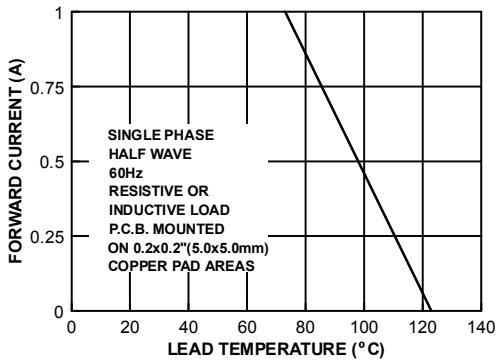

Forward Characteristics

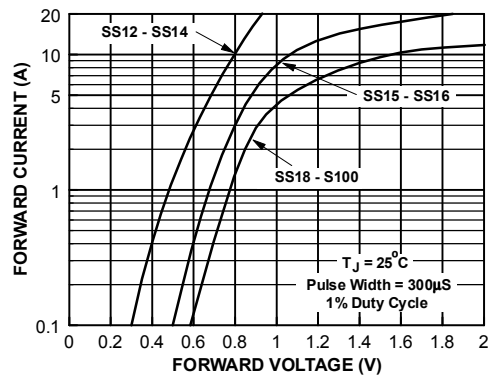

Non-Repetitive Surge Current

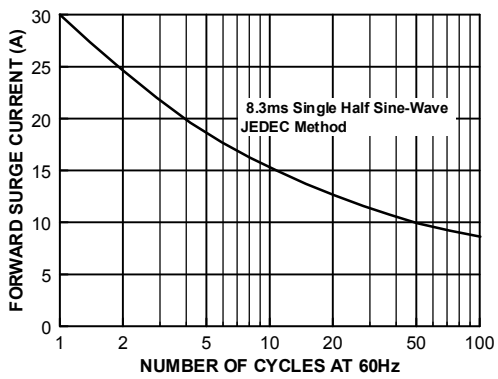

Junction Capacitance

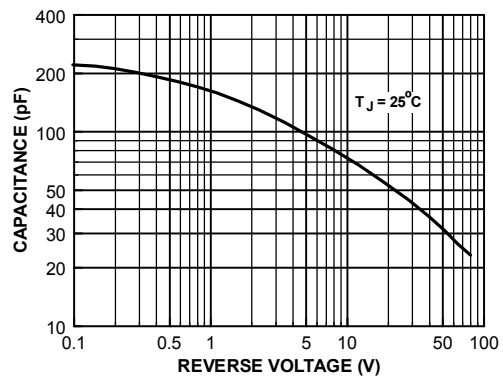

# DO-214AC(SMA) Tape and Reel Data



## DO-214AC(SMA) Packaging Configuration: Figure 1.0

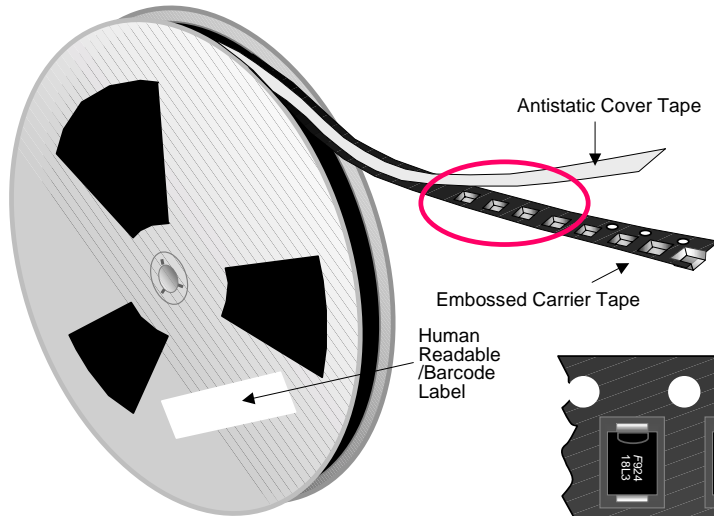

**Packaging Description:**  
 DO-214AC(SMA) parts are shipped in tape. The carrier tape is made from a dissipative (carbon filled) polycarbonate resin. Alternate carrier tape is made of anti-static plastic. The cover tape is a multilayer film (Heat Activated Adhesive in nature) primarily composed of polyester film, adhesive layer, sealant, and anti-static sprayed agent. These reeled parts in standard option are shipped with 7,500 units per 13" or 330cm diameter reel. The reel comes in plastic or carton which is made of polystyrene plastic (anti-static coated) and thick white paper respectively. Further information is described in the Packaging Information table.  
 These full reels are individually labeled and placed inside a bleach box (illustrated in figure 1.0) made of recyclable carton paper with a Fairchild logo printing. One box contains two reels maximum. Certain number of these boxes are placed inside shipping box which comes in different sizes depending on the number of parts shipped.

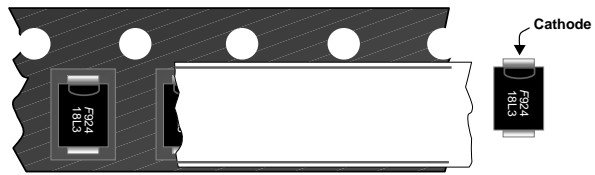

DO-214AC(SMA) unit orientation

DO-214AC(SMA) Packaging Information		
Packaging Option	Under package code P5	Under package code MA
Packaging type	TNR	TNR
Qty per Reel/Tube/Bag	7,500	5,000
Reel Size (inch diameter)	13	13
Box Dimension (mm)	336X336X38	340X350X340
Max qty per Box	15,000	10,000
Weight per unit (gm)	0.064	0.064
Weight per Reel (kg)	0.860	0.750
Note/Comments	Human readable label	Barcode label

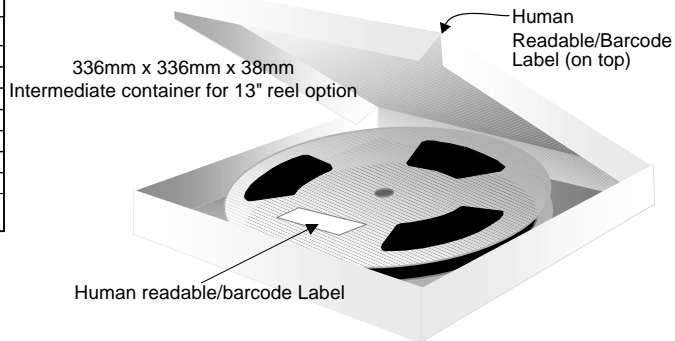

### Human Readable Label sample



### F63TNR Label sample



## DO-214AC(SMA) Tape Leader and Trailer Configuration: Figure 2.0

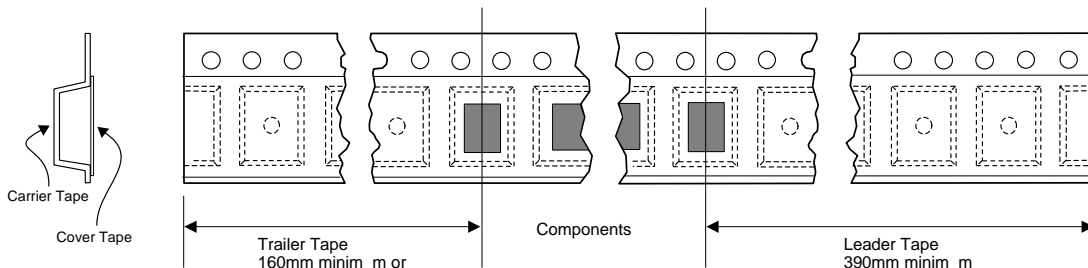

# DO-214AC(SMA) Tape and Reel Data, continued

## DO-214AC(SMA) Embossed Carrier Tape Configuration: Figure 3.0

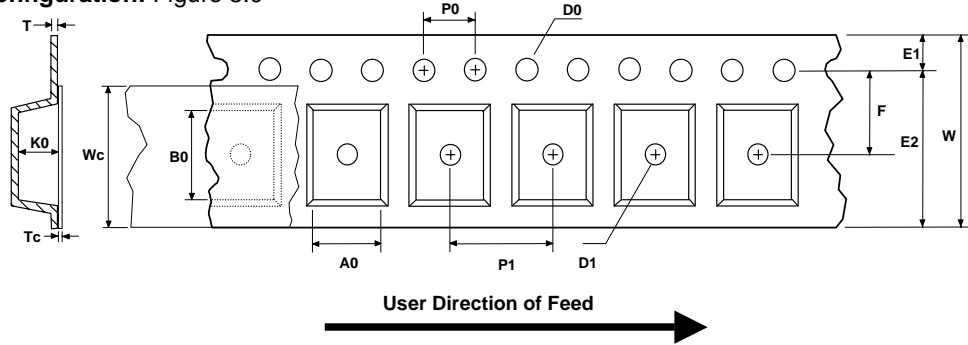

Dimensions are in millimeter														
Pkg type	A0	B0	W	D0	D1	E1	E2	F	P1	P0	K0	T	Wc	Tc
DO-214AC(SMA) (12mm)	2.72 ±0.10	5.25 ±0.10	12.0 ±0.3	1.55 ±0.05	1.125 ±0.125	1.75 ±0.10	10.25 min	5.5 ±0.05	4.0 ±0.1	4.0 ±0.1	2.45 ±0.10	0.23 ±0.10	9.3 ±0.025	0.06 ±0.02

Notes: A0, B0, and K0 dimensions are determined with respect to the EIA/Jedec RS-481 rotational and lateral movement requirements (see sketches A, B, and C).

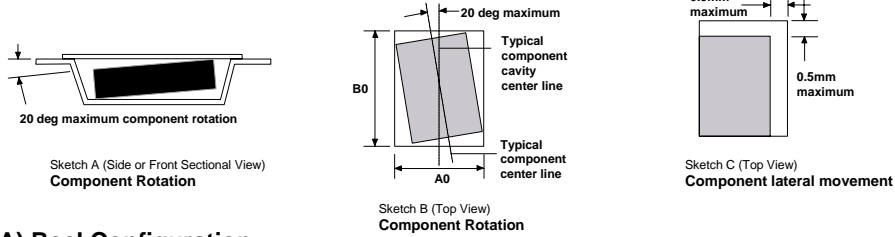

## DO-214AC(SMA) Reel Configuration: Figure 4.0

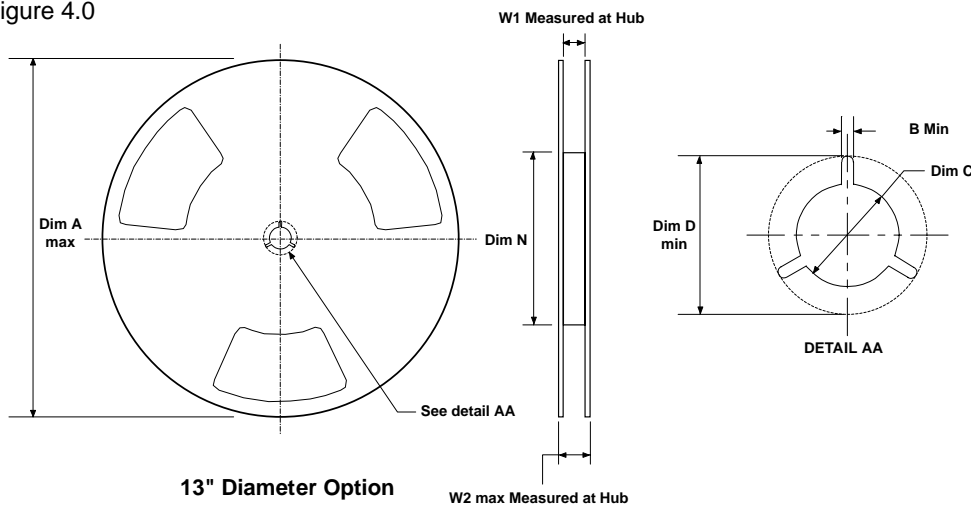

Dimensions are in inches and millimeters								
Tape Size	Reel Option	Dim A	Dim B	Dim C	Dim D	Dim N	Dim W1	Dim W2
12mm	13" Dia	13.0 330	0.059 1.5	512 +0.020/-0.008 13 +0.5/-0.2	0.795 20.2	1.97 50 min	0.331 +0.059/-0.000 8.4 +1.5/0	0.567 14.4

# DO-214AC(SMA) Package Dimensions



## DO-214AC(SMA) (FS PKG Code P5)

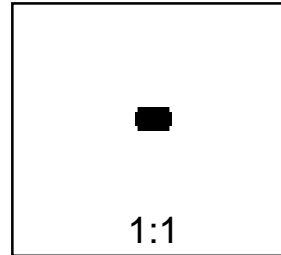
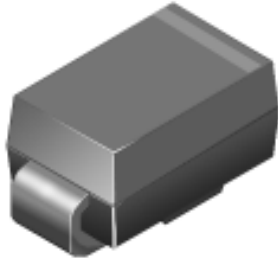

Scale 1:1 on letter size paper

Dimensions shown below are in:  
inches [millimeters]

Part Weight per unit (gram): 0.064

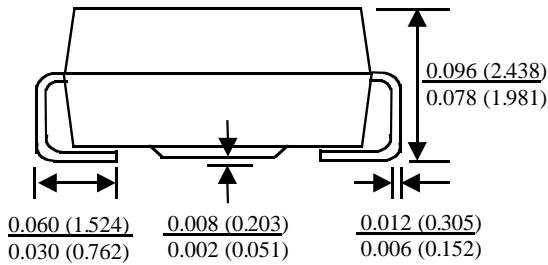
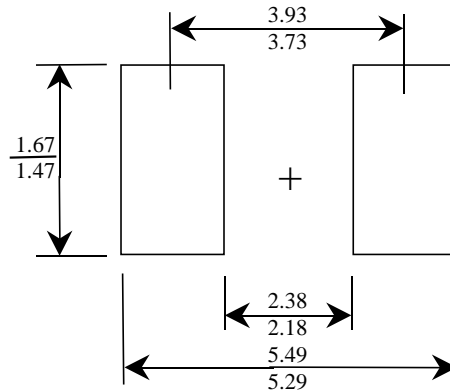
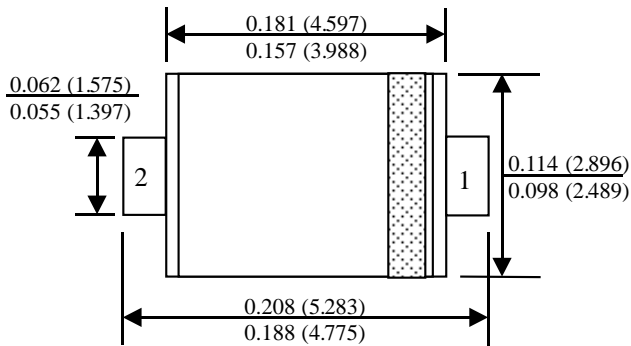

## TRADEMARKS

The following are registered and unregistered trademarks Fairchild Semiconductor owns or is authorized to use and is not intended to be an exhaustive list of all such trademarks.

ACEx™	FASTr™	PowerTrench®	SyncFET™
Bottomless™	GlobalOptoisolator™	QFET™	TinyLogic™
CoolFET™	GTO™	QS™	UHC™
CROSSVOLT™	HiSeC™	QT Optoelectronics™	VCX™
DOME™	ISOPLANAR™	Quiet Series™	
E <sup>2</sup> CMOS™	MICROWIRE™	SILENT SWITCHER®	
EnSigna™	OPTOLOGIC™	SMART START™	
FACT™	OPTOPLANAR™	SuperSOT™-3	
FACT Quiet Series™	PACMAN™	SuperSOT™-6	
FAST®	POP™	SuperSOT™-8	

## DISCLAIMER

FAIRCHILD SEMICONDUCTOR RESERVES THE RIGHT TO MAKE CHANGES WITHOUT FURTHER NOTICE TO ANY PRODUCTS HEREIN TO IMPROVE RELIABILITY, FUNCTION OR DESIGN. FAIRCHILD DOES NOT ASSUME ANY LIABILITY ARISING OUT OF THE APPLICATION OR USE OF ANY PRODUCT OR CIRCUIT DESCRIBED HEREIN; NEITHER DOES IT CONVEY ANY LICENSE UNDER ITS PATENT RIGHTS, NOR THE RIGHTS OF OTHERS.

## LIFE SUPPORT POLICY

FAIRCHILD'S PRODUCTS ARE NOT AUTHORIZED FOR USE AS CRITICAL COMPONENTS IN LIFE SUPPORT DEVICES OR SYSTEMS WITHOUT THE EXPRESS WRITTEN APPROVAL OF FAIRCHILD SEMICONDUCTOR CORPORATION. As used herein:

1. Life support devices or systems are devices or systems which, (a) are intended for surgical implant into the body, or (b) support or sustain life, or (c) whose failure to perform when properly used in accordance with instructions for use provided in the labeling, can be reasonably expected to result in significant injury to the user.
2. A critical component is any component of a life support device or system whose failure to perform can be reasonably expected to cause the failure of the life support device or system, or to affect its safety or effectiveness.

## PRODUCT STATUS DEFINITIONS

### Definition of Terms

Datasheet Identification	Product Status	Definition
Advance Information	Formative or In Design	This datasheet contains the design specifications for product development. Specifications may change in any manner without notice.
Preliminary	First Production	This datasheet contains preliminary data, and supplementary data will be published at a later date. Fairchild Semiconductor reserves the right to make changes at any time without notice in order to improve design.
No Identification Needed	Full Production	This datasheet contains final specifications. Fairchild Semiconductor reserves the right to make changes at any time without notice in order to improve design.
Obsolete	Not In Production	This datasheet contains specifications on a product that has been discontinued by Fairchild semiconductor. The datasheet is printed for reference information only.