

**PNP Silicon AF Transistor Array**

- For AF input stages and driver applications
- High current gain
- Low collector-emitter saturation voltage
- Two ( galvanic) internal isolated Transistors with good matching in one package

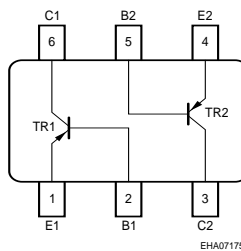
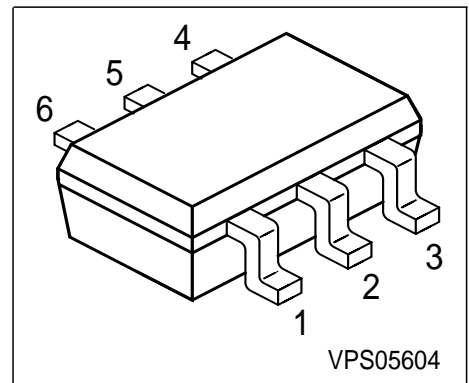

Type	Marking	Pin Configuration				Package		
BC856S	3Ds	1=E1	2=B1	3=C2	4=E2	5=B2	6=C1	SOT363

**Maximum Ratings**

Parameter	Symbol	Value	Unit
Collector-emitter voltage	$V_{CEO}$	65	V
Collector-base voltage	$V_{CBO}$	80	
Collector-emitter voltage	$V_{CES}$	80	
Emitter-base voltage	$V_{EBO}$	5	
DC collector current	$I_C$	100	mA
Peak collector current	$I_{CM}$	200	
Total power dissipation, $T_S = 115\text{ °C}$	$P_{tot}$	250	mW
Junction temperature	$T_j$	150	°C
Storage temperature	$T_{stg}$	-65 ... 150	

**Thermal Resistance**

Junction - soldering point <sup>1)</sup>	$R_{thJS}$	≤140	K/W
--	------------	------	-----

<sup>1)</sup>For calculation of  $R_{thJA}$  please refer to Application Note Thermal Resistance

**Electrical Characteristics at  $T_A=25^\circ\text{C}$ , unless otherwise specified**

Parameter	Symbol	Values			Unit
		min.	typ.	max.	
<b>DC Characteristics per Transistor</b>					
Collector-emitter breakdown voltage $I_C = 10 \text{ mA}, I_B = 0$	$V_{(BR)CEO}$	65	-	-	V
Collector-base breakdown voltage $I_C = 10 \mu\text{A}, I_E = 0$	$V_{(BR)CBO}$	80	-	-	
Collector-emitter breakdown voltage $I_C = 10 \mu\text{A}, V_{BE} = 0$	$V_{(BR)CES}$	80	-	-	
Emitter-base breakdown voltage $I_E = 10 \mu\text{A}, I_C = 0$	$V_{(BR)EBO}$	5	-	-	
Collector cutoff current $V_{CB} = 30 \text{ V}, I_E = 0$	$I_{CBO}$	-	-	15	nA
Collector cutoff current $V_{CB} = 30 \text{ V}, I_E = 0, T_A = 150^\circ\text{C}$	$I_{CBO}$	-	-	5	$\mu\text{A}$
DC current gain 1) $I_C = 10 \mu\text{A}, V_{CE} = 5 \text{ V}$ $I_C = 2 \text{ mA}, V_{CE} = 5 \text{ V}$	$h_{FE}$	- 200	250 290	- 475	-
Collector-emitter saturation voltage1) $I_C = 10 \text{ mA}, I_B = 0.5 \text{ mA}$ $I_C = 100 \text{ mA}, I_B = 5 \text{ mA}$	$V_{CEsat}$	- -	90 250	300 650	mV
Base-emitter saturation voltage 1) $I_C = 10 \text{ mA}, I_B = 0.5 \text{ mA}$ $I_C = 100 \text{ mA}, I_B = 5 \text{ mA}$	$V_{BEsat}$	- -	700 850	- -	
Base-emitter voltage 1) $I_C = 2 \text{ mA}, V_{CE} = 5 \text{ V}$ $I_C = 10 \text{ mA}, V_{CE} = 5 \text{ V}$	$V_{BE(ON)}$	600 -	650 -	750 820	

 1) Pulse test:  $t < 300\mu\text{s}$ ;  $D < 2\%$

**Electrical Characteristics** at  $T_A = 25\text{ °C}$ , unless otherwise specified.

Parameter	Symbol	Values			Unit
		min.	typ.	max.	
<b>AC characteristics</b>					
Transition frequency $I_C = 20\text{ mA}$ , $V_{CE} = 5\text{ V}$ , $f = 100\text{ MHz}$	$f_T$	-	250	-	MHz
Collector-base capacitance $V_{CB} = 10\text{ V}$ , $f = 1\text{ MHz}$	$C_{cb}$	-	3	-	pF
Emitter-base capacitance $V_{EB} = 0.5\text{ V}$ , $f = 1\text{ MHz}$	$C_{eb}$	-	8	-	
Short-circuit input impedance $I_C = 2\text{ mA}$ , $V_{CE} = 5\text{ V}$ , $f = 1\text{ kHz}$	$h_{11e}$	-	4.5	-	k $\Omega$
Open-circuit reverse voltage transf.ratio $I_C = 2\text{ mA}$ , $V_{CE} = 5\text{ V}$ , $f = 1\text{ kHz}$	$h_{12e}$	-	2	-	$10^{-4}$
Short-circuit forward current transf.ratio $I_C = 2\text{ mA}$ , $V_{CE} = 5\text{ V}$ , $f = 1\text{ kHz}$	$h_{21e}$	-	330	-	-
Open-circuit output admittance $I_C = 2\text{ mA}$ , $V_{CE} = 5\text{ V}$ , $f = 1\text{ kHz}$	$h_{22e}$	-	30	-	$\mu\text{S}$
Noise figure $I_C = 200\text{ }\mu\text{A}$ , $V_{CE} = 5\text{ V}$ , $R_S = 2\text{ k}\Omega$ , $f = 1\text{ kHz}$ , $\Delta f = 200\text{ Hz}$	$F$	-	-	10	dB

**Total power dissipation  $P_{tot} = f(T_S)$**

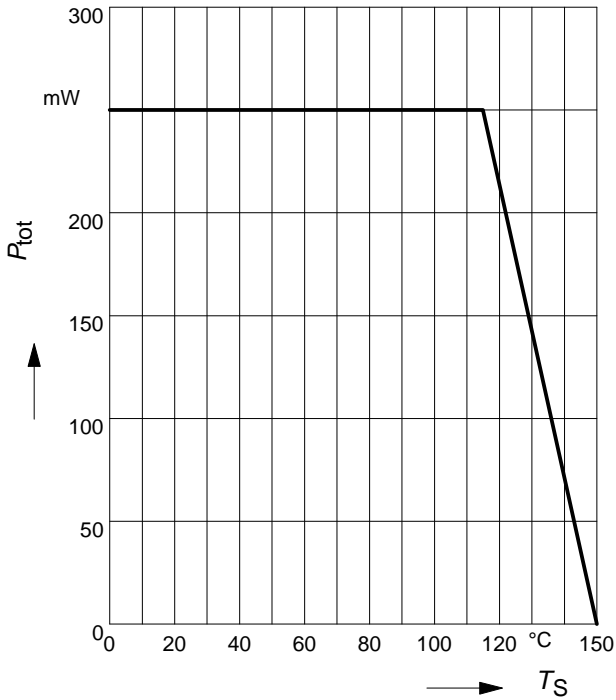

**Permissible Pulse Load  $R_{thJS} = f(t_p)$**

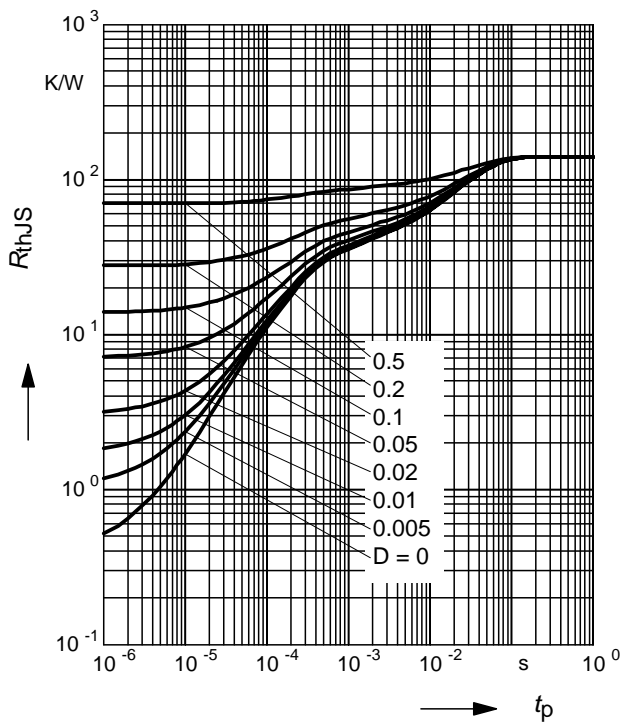

**Permissible Pulse Load**

$P_{totmax} / P_{totDC} = f(t_p)$

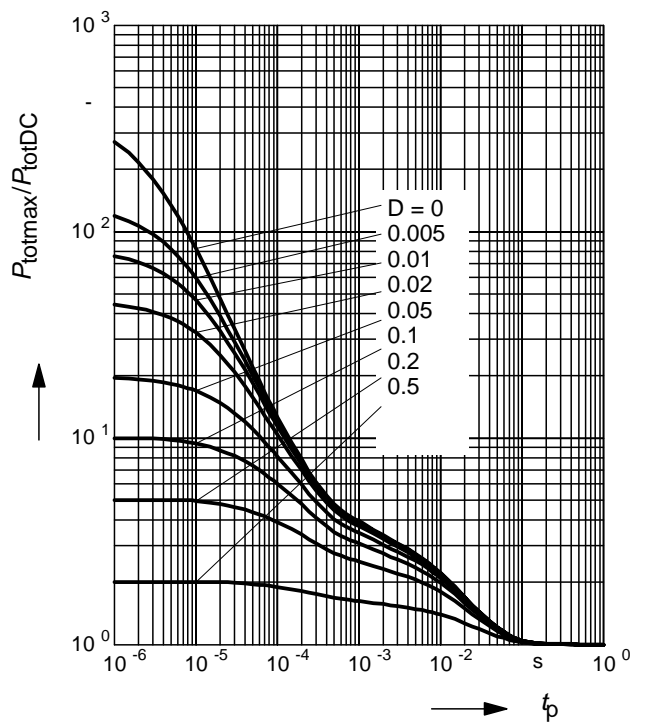

**Transition frequency  $f_T = f(I_C)$**

$V_{CE} = 5V$

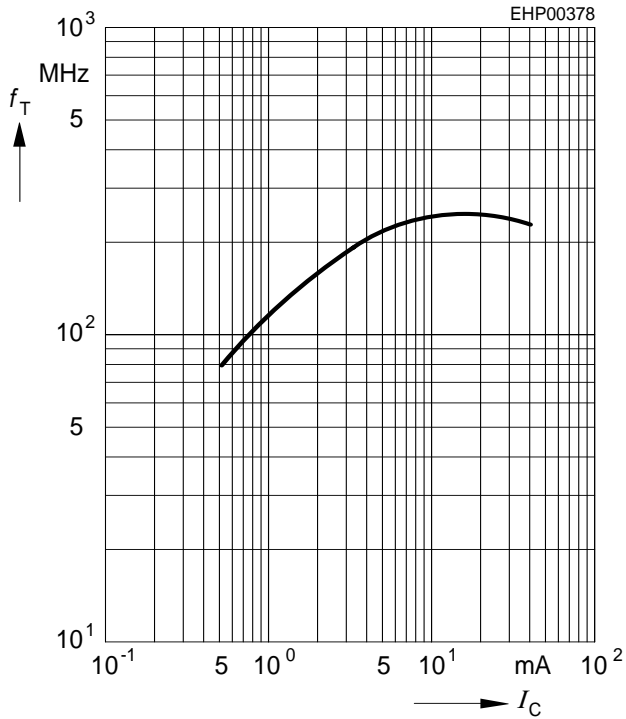

**Collector-base capacitance  $C_{CB} = f(V_{CB0})$**

**Emitter-base capacitance  $C_{EB} = f(V_{EB0})$**

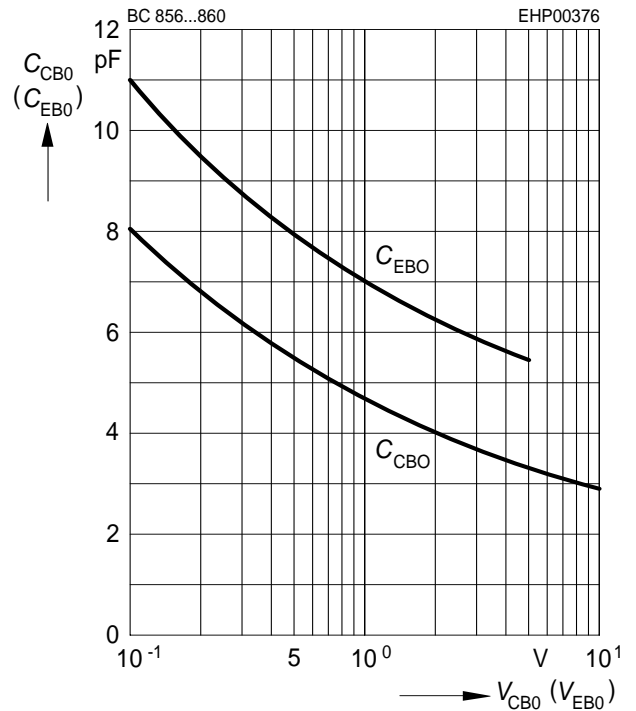

**Collector cutoff current  $I_{CBO} = f(T_A)$**

$V_{CB} = 30V$

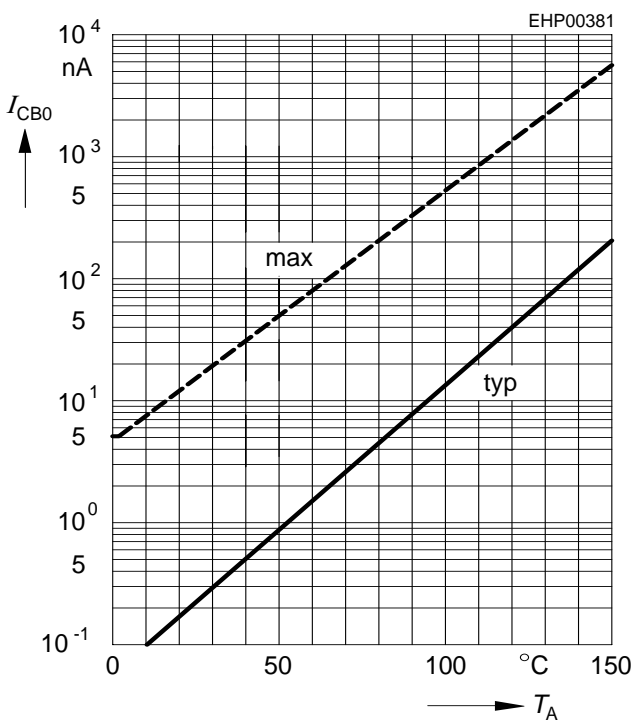

**Collector-emitter saturation voltage**

$I_C = f(V_{CEsat}), h_{FE} = 20$

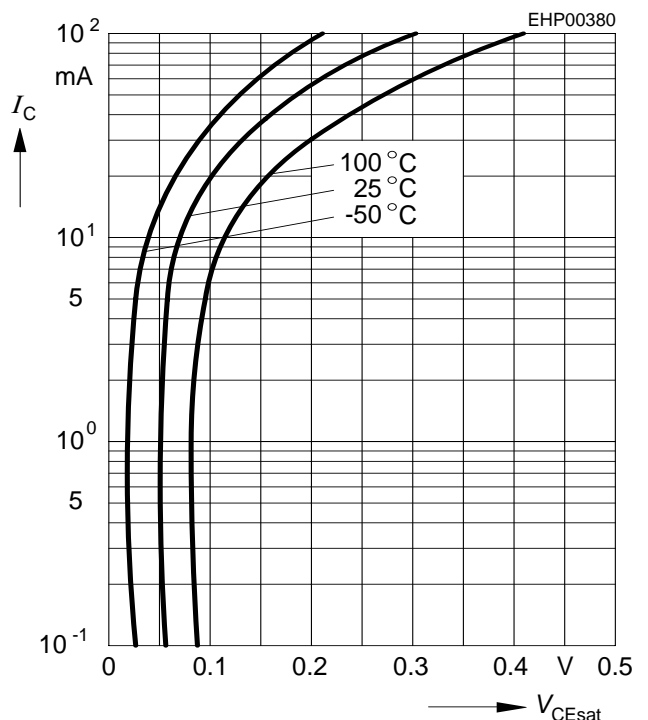

**DC current gain  $h_{FE} = f(I_C)$**

$V_{CE} = 5V$

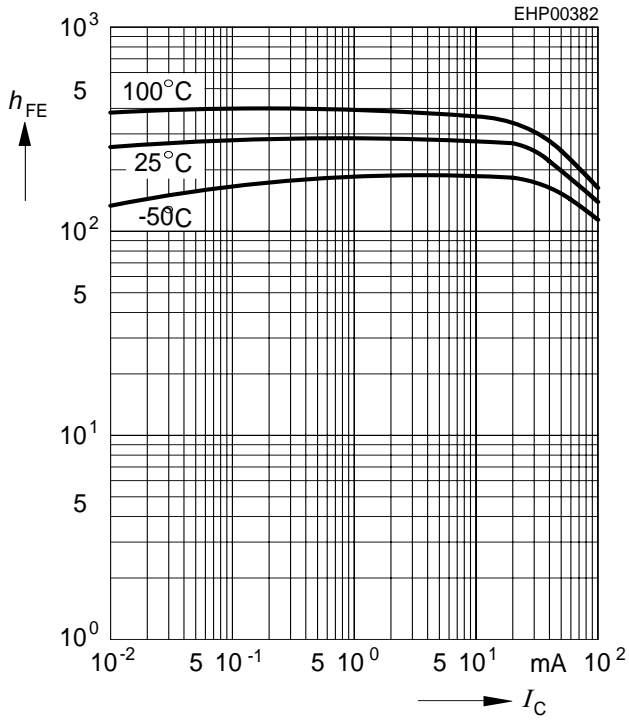

**Base-emitter saturation voltage**

$I_C = f(V_{BEsat}), h_{FE} = 20$

