

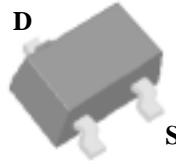

- ▼ Capable of 2.5V gate drive
- ▼ Lower on-resistance
- ▼ Surface mount package



SOT-23 G

$BV_{DSS}$	20V
$R_{DS(ON)}$	32mΩ
$I_D$	5.3A

**Description**

Advanced Power MOSFETs utilized advanced processing techniques to achieve the lowest possible on-resistance, extremely efficient and cost-effectiveness device.

The SOT-23 package is universally used for all commercial-industrial applications.

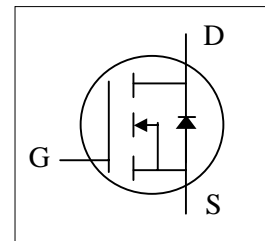

**Absolute Maximum Ratings**

Symbol	Parameter	Rating	Units
$V_{DS}$	Drain-Source Voltage	20	V
$V_{GS}$	Gate-Source Voltage	± 12	V
$I_D@T_A=25^{\circ}C$	Continuous Drain Current <sup>3</sup> , $V_{GS}$ @ 4.5V	5.3	A
$I_D@T_A=70^{\circ}C$	Continuous Drain Current <sup>3</sup> , $V_{GS}$ @ 4.5V	4.3	A
$I_{DM}$	Pulsed Drain Current <sup>1,2</sup>	10	A
$P_D@T_A=25^{\circ}C$	Total Power Dissipation	1.38	W
	Linear Derating Factor	0.01	W/°C
$T_{STG}$	Storage Temperature Range	-55 to 150	°C
$T_J$	Operating Junction Temperature Range	-55 to 150	°C

**Thermal Data**

Symbol	Parameter	Value	Unit
Rthj-a	Thermal Resistance Junction-ambient <sup>3</sup> Max.	90	°C/W



# AP2306GN

## Electrical Characteristics @ $T_j=25^\circ\text{C}$ (unless otherwise specified)

Symbol	Parameter	Test Conditions	Min.	Typ.	Max.	Units
$BV_{DSS}$	Drain-Source Breakdown Voltage	$V_{GS}=0V, I_D=250\mu A$	20	-	-	V
$\Delta BV_{DSS}/\Delta T_j$	Breakdown Voltage Temperature Coefficient	Reference to $25^\circ\text{C}$ , $I_D=1\text{mA}$	-	0.1	-	$V/^\circ\text{C}$
$R_{DS(ON)}$	Static Drain-Source On-Resistance	$V_{GS}=10V, I_D=5.5A$	-	-	30	$m\Omega$
		$V_{GS}=4.5V, I_D=5.3A$	-	-	35	$m\Omega$
		$V_{GS}=2.5V, I_D=2.6A$	-	-	50	$m\Omega$
		$V_{GS}=1.8V, I_D=1.0A$	-	-	90	$m\Omega$
$V_{GS(th)}$	Gate Threshold Voltage	$V_{DS}=V_{GS}, I_D=250\mu A$	0.5	-	-	V
$g_{fs}$	Forward Transconductance	$V_{DS}=5V, I_D=5.3A$	-	13	-	S
$I_{DSS}$	Drain-Source Leakage Current ( $T_j=25^\circ\text{C}$ )	$V_{DS}=20V, V_{GS}=0V$	-	-	1	$\mu A$
	Drain-Source Leakage Current ( $T_j=55^\circ\text{C}$ )	$V_{DS}=16V, V_{GS}=0V$	-	-	10	$\mu A$
$I_{GSS}$	Gate-Source Leakage	$V_{GS}=\pm 12V$	-	-	$\pm 100$	nA
$Q_g$	Total Gate Charge <sup>2</sup>	$I_D=5.3A$	-	8.7	-	nC
$Q_{gs}$	Gate-Source Charge	$V_{DS}=10V$	-	1.5	-	nC
$Q_{gd}$	Gate-Drain ("Miller") Charge	$V_{GS}=4.5V$	-	3.6	-	nC
$t_{d(on)}$	Turn-on Delay Time <sup>2</sup>	$V_{DS}=15V$	-	6	-	ns
$t_r$	Rise Time	$I_D=1A$	-	14	-	ns
$t_{d(off)}$	Turn-off Delay Time	$R_G=2\Omega, V_{GS}=10V$	-	18.4	-	ns
$t_f$	Fall Time	$R_D=15\Omega$	-	2.8	-	ns
$C_{iss}$	Input Capacitance	$V_{GS}=0V$	-	603	-	pF
$C_{oss}$	Output Capacitance	$V_{DS}=15V$	-	144	-	pF
$C_{rss}$	Reverse Transfer Capacitance	$f=1.0\text{MHz}$	-	111	-	pF

## Source-Drain Diode

Symbol	Parameter	Test Conditions	Min.	Typ.	Max.	Units
$V_{SD}$	Forward On Voltage <sup>2</sup>	$I_S=1.2A, V_{GS}=0V$	-	-	1.2	V
$t_{rr}$	Reverse Recovery Time	$I_S=5A, V_{GS}=0V,$	-	16.8	-	ns
$Q_{rr}$	Reverse Recovery Charge	$dI/dt=100A/\mu s$	-	11	-	nC

### Notes:

1. Pulse width limited by Max. junction temperature.
2. Pulse width  $\leq 300\mu s$ , duty cycle  $\leq 2\%$ .
3. Surface mounted on 1 in<sup>2</sup> copper pad of FR4 board ;  $270^\circ\text{C}/W$  when mounted on min. copper pad.

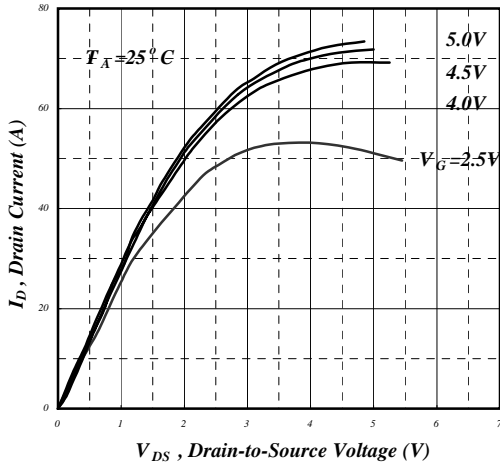

Fig 1. Typical Output Characteristics

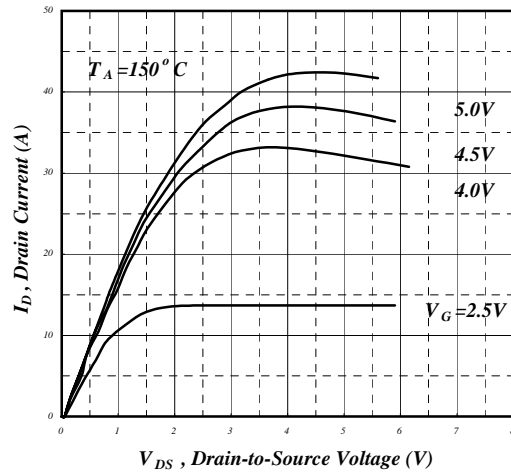

Fig 2. Typical Output Characteristics

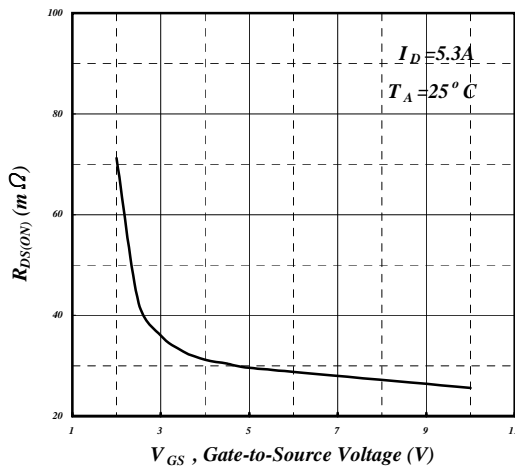

Fig 3. On-Resistance v.s. Gate Voltage

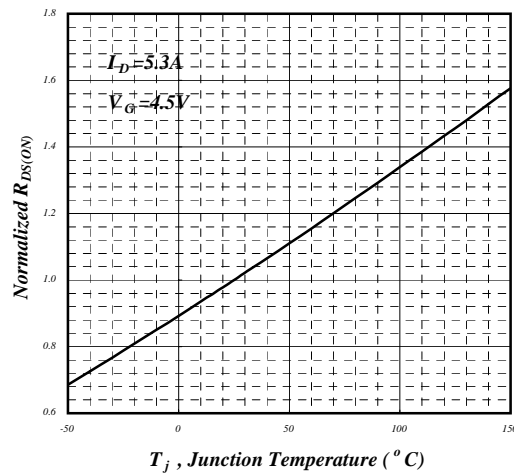

Fig 4. Normalized On-Resistance v.s. Junction Temperature

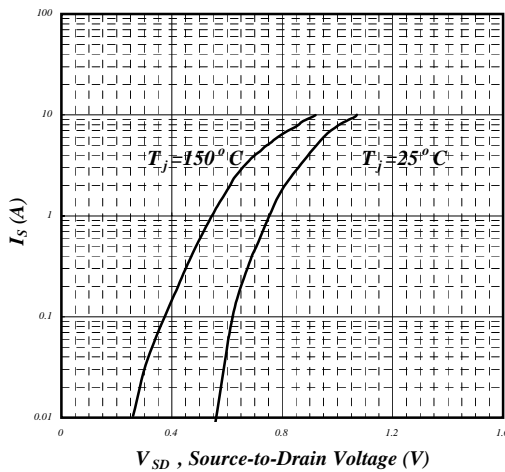

Fig 5. Forward Characteristic of Reverse Diode

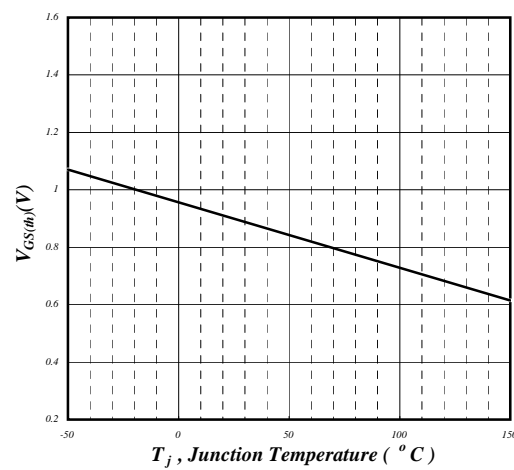

Fig 6. Gate Threshold Voltage v.s. Junction Temperature

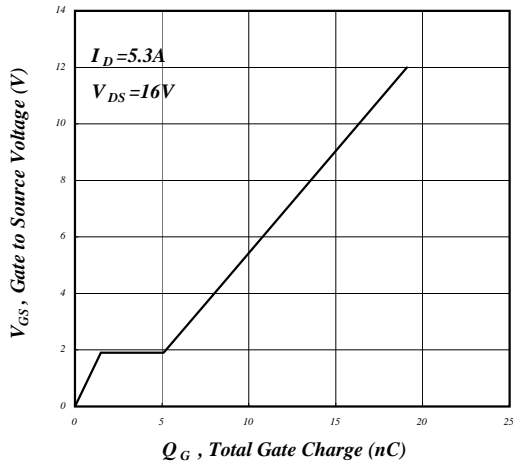

Fig 7. Gate Charge Characteristics

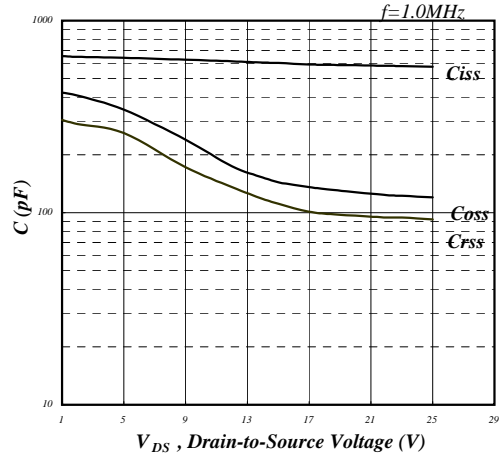

Fig 8. Typical Capacitance Characteristics

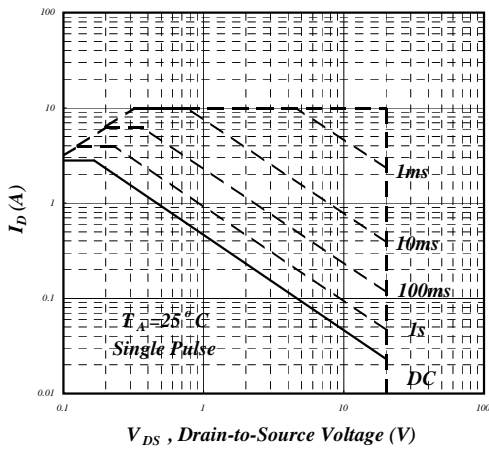

Fig 9. Maximum Safe Operating Area

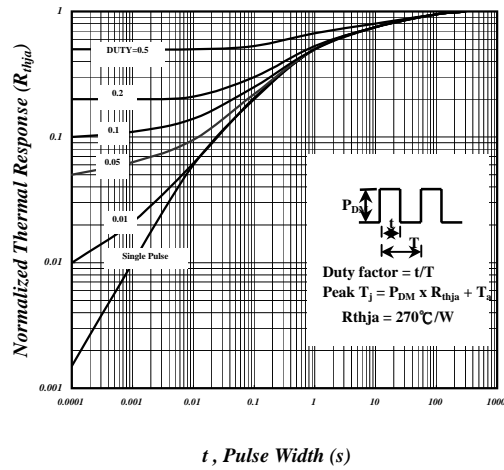

Fig 10. Effective Transient Thermal Impedance

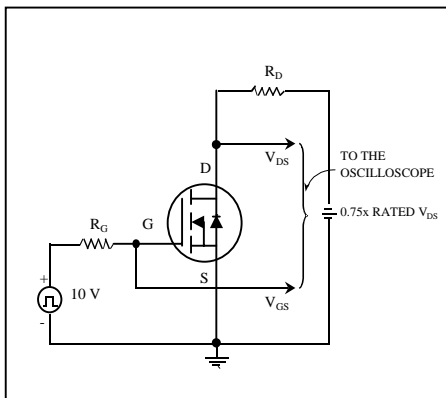

Fig 11. Switching Time Circuit

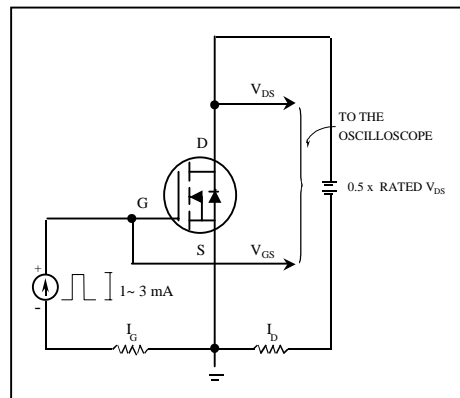

Fig 12. Gate Charge Circuit