

Typical Performance Characteristics

COG

APPLICATION - Suited for precision circuits, Requiring stable dielectric characteristics :

- Negligible dependence of capacitance and dissipation factor on time, voltage, and frequency.

DIELECTRIC CHARACTERISTICS

Temperature Coefficient	$0 \pm 30 \text{ ppm}/^\circ\text{C}$
Temperature Range	-55°C to 125°C
Dissipation Factor	$< 0.001(0.1\%)$ @ 1MHz, 25°C (1KHz, above 1000pF)
Quality Factor	> 1000 (1KHz, above 1000pF)
Insulation Resistance	$> 1000 \text{ } \Omega\text{F}$ or $1000 \text{ G} \text{ } \Omega$, whichever is less, @ 25°C , VDCW. @ 125°C , IR is 1% of 25°C requirement
Dielectric Strength	$> 2.5 \times \text{VDCW}$. 50mA Max
Test Parameters	1MHz $\pm 50\text{KHz}$, $1.0 \pm 0.2 \text{ VRMS}$, below 1000pF, 25°C 1KHz $\pm 50\text{Hz}$, $1.0 \pm 0.2 \text{ VRMS}$, above 1000pF, 25°C

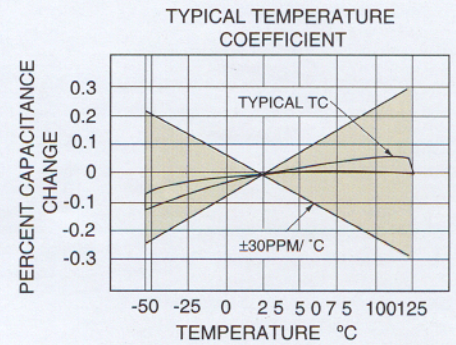

X7R

APPLICATION - Stable Class II dielectric properties, suited for by-pass and coupling purposes, filtering, frequency discrimination, DC blockage, and as voltage transient suppression elements.

DIELECTRIC CHARACTERISTICS

Capacitance Change	$\Delta C \ 0 \pm 15\%$
Temperature Range	-55°C to 125°C
Dissipation Factor	$< 0.025(2.5\%)$ @ 1KHz, 25°C
Insulation Resistance	$> 1000 \text{ } \Omega\text{F}$ or $100 \text{ G} \text{ } \Omega$, whichever is less, @ 25°C , VDCW. @ 125°C , IR is 10% Of 25°C requirement
Dielectric Strength	$> 2.5 \times \text{VDCW}$. 50mA Max
Aging	$< 2.5\%$ / decade hour
Test Parameters	1KHz $\pm 50\text{Hz}$, $1.0 \pm 0.2 \text{ VRMS}$, 25°C

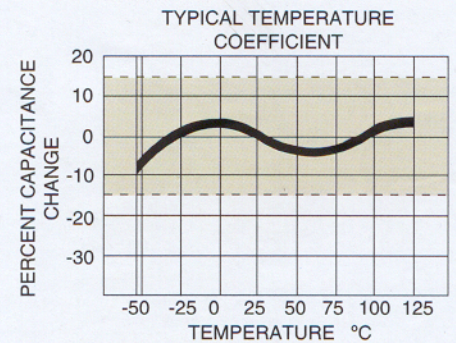

Z5U / Y5V

APPLICATION - The Hi-K(Z5U, Y5V) dielectrics deliver high capacitance density and are ideally suited for applications where space is at a premium, or as replacement for tantalum capacitors, Typical applications include use as by-pass or decoupling elements.

Best performance is obtained at or near room temperature, with low D.C. bias

DIELECTRIC CHARACTERISTICS

Capacitance Change	Z5U/Y5V: $\Delta C\% +22 \sim -56 / \Delta C\% +22 \sim -82$
Temperature Range	Z5U/Y5V: $10^\circ\text{C} \sim +85^\circ\text{C} / -30^\circ\text{C} \sim +85^\circ\text{C}$
Dissipation Factor	Z5U/Y5V: < 0.04 (4%) / < 0.05 (5%) @ 1KHz, 25°C
Insulation Resistance	$> 1000 \text{ } \Omega\text{F}$ or $100 \text{ G} \text{ } \Omega$, whichever is less, @ 25°C VDCW
Dielectric Strength	$> 2.5 \times \text{VDCW}$, 50mA Max
Aging	$< 5\%$ / decade hour
Test Parameters	1KHz $\pm 50\text{Hz}$, 0.5 VRMS , 25°C

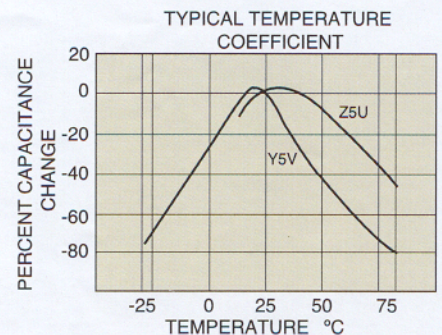

MULTI-LAYER CERAMIC CAPACITORS

SMD Type

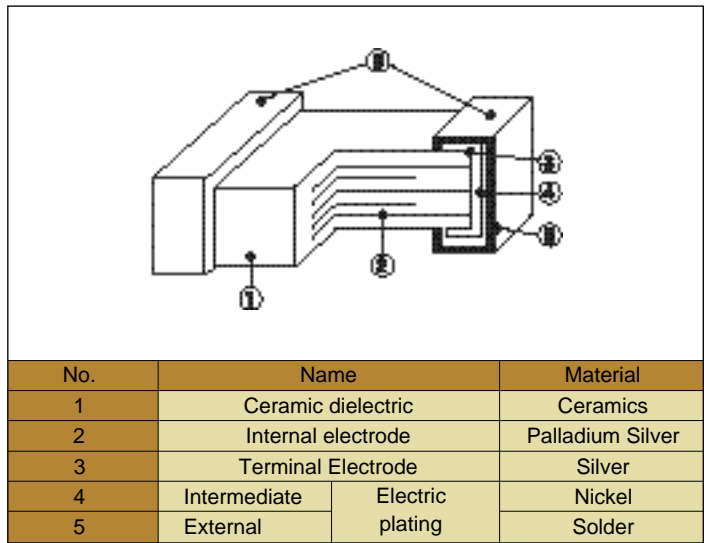
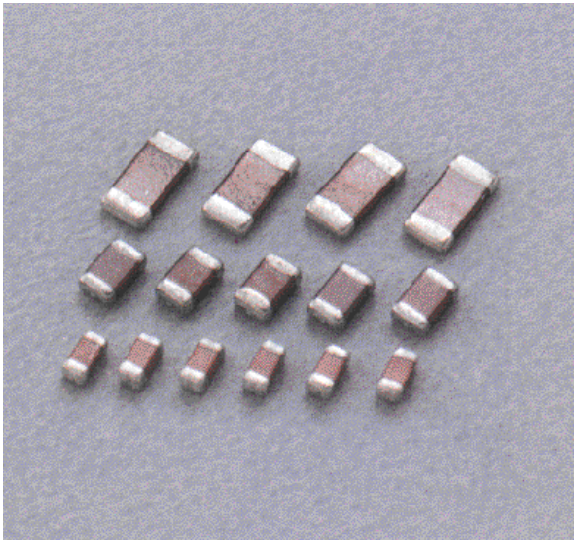

TYPE DESIGNATION (HOW TO ORDER)

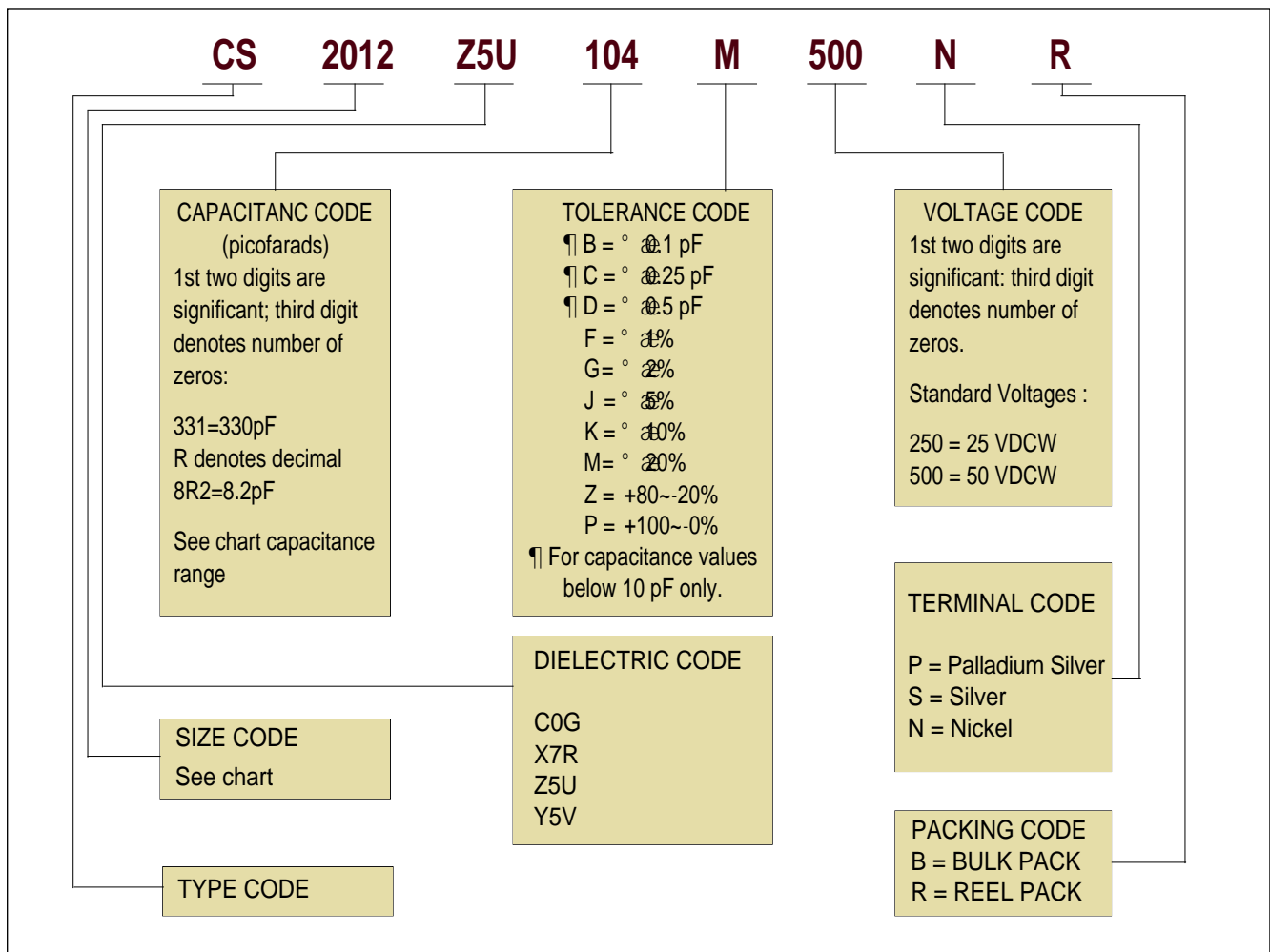

MULTI-LAYER CERAMIC CAPACITORS

SMD Type

CAPACITANCE RANGE AND DIMENSIONS BY TYPE

SIZE CODE		1608				2012				3216				3225				
SIZE(mm)	L	1.60° 0.1				2.00° 0.20				3.20° 0.25				3.20° 0.25				
	W	0.80° 0.1				1.25° 0.15				1.60° 0.20				2.50° 0.25				
	T	0.80° 0.1				1.20 MAX				1.20 MAX				1.30 MAX				
CAPACITANCE VALUE		C0G	X7R	Z5U	Y5V	C0G	X7R	Z5U	Y5V	C0G	X7R	Z5U	Y5V	C0G	X7R	Z5U	Y5V	
0.5pF	0R5	0R5				0R5				0R5								
1	010																	
2	020																	
3	030																	
4	040																	
5	050																	
6	060																	
7	070																	
8	080																	
9	090																	
10	100																	
12	120																	
15	150																	
16	160																	
18	180																	
20	200																	
22	220																	
24	240																	
27	270																	
30	300																	
33	330																	
36	360																	
39	390		390															
43	430																	
47	470																	
51	510																	
56	560																	
62	620																	
68	680																	
75	750			750														
82	820																	
91	910																	
100	101						101				101							
120	121																	
150	151																	
180	181																	
220	221																	
270	271																	
330	331				331													
390	391																	
470	471	471																
560	561																	
680	681																	
820	821																	
1000	102					102		102								102		
1200	122																	
1500	152																	
1800	182																	
2200	222																	
2700	272									272								
3300	332																	
3900	392																	
4700	472																	
5600	562																	
6800	682																	
8200	822																	
10nF	103																103	103
15	153		153									103	103					
22	223			223														
33	333																	
47	473																	
68	683																	
100	104				104		104	104			104							
150	154																	
220	224																	
330	334																	
470	474											474					474	
680	684																	
1000	105								105				105					105



MULTI-LAYER CERAMIC CAPACITORS

SMD Type

REEL PACKING DIMENSIONS

REEL DIMENSIONS

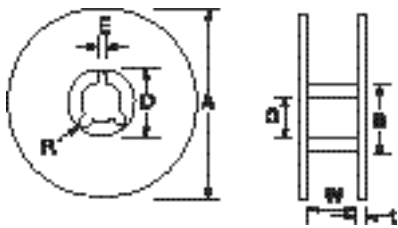

(Unit : mm)

A	$\beta \geq 178A^\circ \pm 2$	E	$2.0^\circ \pm 0.5$
B	$\beta \geq 50\text{Min}$	W	$10.0^\circ \pm 0.5$
C	$\beta \geq 13.0^\circ \pm 0.5$	t	$2.0^\circ \pm 0.5$
D	$\beta \geq 21.0^\circ \pm 0.8$	R	1.0

TAPE DIMENSIONS

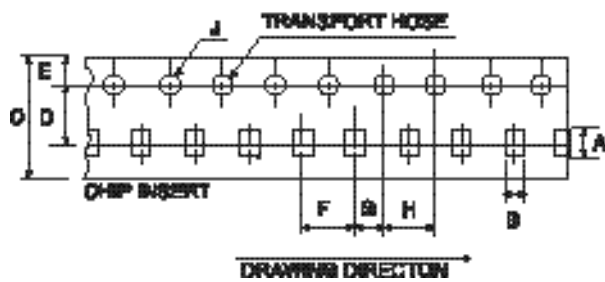

NUMBER OF PACKAGES

TYPE	EIA CODE	Qt / REEL
CS1608	CC0603	4.000pcs
CS2012	CC0805	4.000
CS3216	CC1206	3.000
CS3225	CC1210	3.000

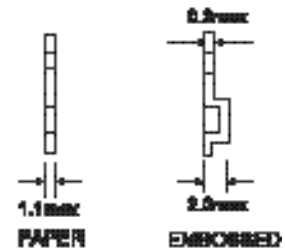

(Unit : mm)

TYPE	EIA CODE	A	B	C	D	E	F	G	H	J
CS1608	CC0603	$2.0^\circ \pm 0.2$	$1.20^\circ \pm 0.2$	$8.0^\circ \pm 0.3$	$3.5^\circ \pm 0.05$	$1.75^\circ \pm 0.1$	$4.0^\circ \pm 0.1$	$2.0^\circ \pm 0.05$	$4.0^\circ \pm 0.1$	$1.5^\circ \pm 0.1$ $^\circ \pm 0.1$
CS2012	CC0805	$2.4^\circ \pm 0.2$	$1.65^\circ \pm 0.2$	$8.0^\circ \pm 0.3$	$3.5^\circ \pm 0.05$	$1.75^\circ \pm 0.1$	$4.0^\circ \pm 0.1$	$2.0^\circ \pm 0.05$	$4.0^\circ \pm 0.1$	$1.5^\circ \pm 0.1$ $^\circ \pm 0.1$
CS3216	CC1206	$3.6^\circ \pm 0.2$	$2.00^\circ \pm 0.2$	$8.0^\circ \pm 0.3$	$3.5^\circ \pm 0.05$	$1.75^\circ \pm 0.1$	$4.0^\circ \pm 0.1$	$2.0^\circ \pm 0.05$	$4.0^\circ \pm 0.1$	$1.5^\circ \pm 0.1$ $^\circ \pm 0.1$
CS3225	CC1210	$3.6^\circ \pm 0.2$	$2.90^\circ \pm 0.2$	$8.0^\circ \pm 0.3$	$3.5^\circ \pm 0.05$	$1.75^\circ \pm 0.1$	$4.0^\circ \pm 0.1$	$2.0^\circ \pm 0.05$	$4.0^\circ \pm 0.1$	$1.5^\circ \pm 0.1$ $^\circ \pm 0.1$

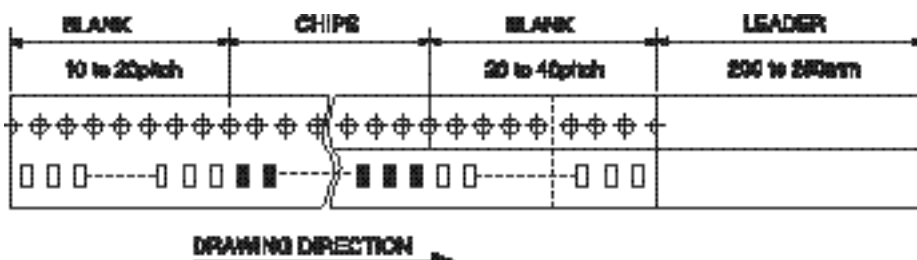

TAPING (FIGURE)

(1) EMBOSSED TAPE

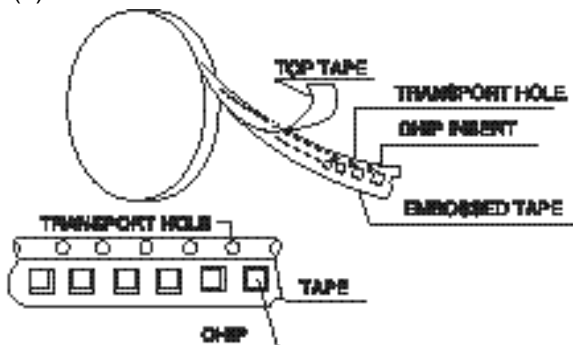

(2) PAPER TAPE

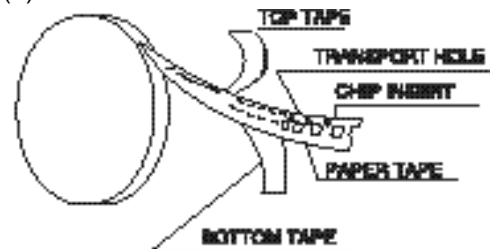

MULTI-LAYER CERAMIC CAPACITORS

Radial & Axial

TYPE DESIGNATION (HOW TO ORDER)

(HOW TO ORDER)

CR 051B X7R 104 M 500 B
 CA 2644 Z5U 104 M 500 R

CAPACITANCE CODE
 THIS IS EXPRESSED IN PICO FARADS THE FIRST DIGITS ARE SIGNIFICANT FIGURES. THE THIRD IS THE NUMBER OF ZEROS.

EIA TEMPERATURE CHARACTERISTICS		
EIA Characteristic	Temperature Range	Maximum Capacitance Change Over Temperature Range
Z5U	+10° to +85°	-56% + 22%
X7R	-55° to +125°	° 15%
COG(NPO)	-55° to +125°	0° 30ppm/°
Y5V	-30° to +85°	-82%+22%

VOLTAGE RATING.
 THE D.C WORKING VOLTAGE RATING AT MAXIMUM OPERATING TEMPERATURE THE FIRST TWO DIGITS ARE SIGNIFICANT FIGURES, THE THIRD IS THE NUMBER OF ZEROS

TYPE CODE
 SEE DIMENSIONS.

TOLERANCE CODE

- ¶ B = ° 0.1 pF
- ¶ C = ° 0.25 pF
- ¶ D = ° 0.5 pF
- F = ° 1%
- G = ° 2%
- J = ° 5%
- K = ° 10%
- M = ° 220%
- Z = + 80° 20%
- P = +100° 0%

¶ For capacitance values Below 10 pF only.

PACKING CODE
 B° BULK PACK
 R° REEL PACK
 F° FLAT PACK

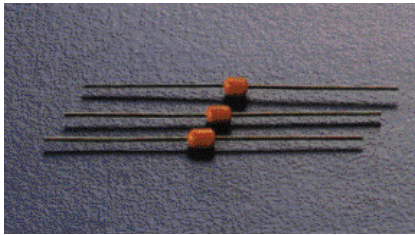
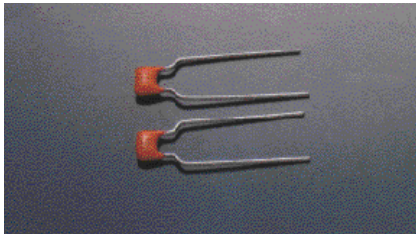

DIMENSIONS BY TYPE

(Unit : mm)

RADIAL							AXIAL				
TYPE	P	H (max)	L (max)	W (max)	β d	T (max)	TYPE	H (max)	L (max)	W (max)	β dj
CR051A	2.5	6.4	5.1	5.1	0.5	3.2	CA2633	3.3	2.6	25	0.5
CR051B	5.0						CA2644	4.4			
CR051D	7.6						CA2666	6.6			
CR077B	5.0	9.2	7.7	7.6							
CR077D	7.6	10.2									

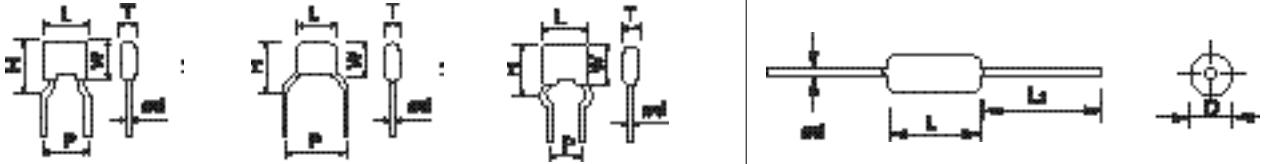

MULTI-LAYER CERAMIC CAPACITORS

Radial & Axial

CAPACITANCE RANGE TYPE

TYPE CAPACITANCE VALUE		RADIAL								AXIAL							
		CR051				CR077				CA2644				CA2666			
		C0G	X7R	Z5U	Y5V	C0G	X7R	Z5U	Y5V	C0G	X7R	Z5U	Y5V	C0G	X7R	Z5U	Y5V
1pF	010	010								010							
2	020																
3	030																
4	040																
5	050																
6	060																
7	070																
8	080																
9	090																
10	100																
12	120																
15	150																
16	160																
18	180																
20	200																
22	220				220								220				
24	240																
27	270																
30	300																
33	330																
36	360																
39	390																
43	430																
47	470																
51	510																
56	560																
62	620																
68	680																
75	750																
82	820																
91	910																
100	101		101								101						
120	121																
150	151																
180	181																
220	221																
270	271																
330	331																
390	391																
470	471																
560	561																
680	681																
820	821																
1000	102			102		102					102			102	102		
1200	122									122							
1500	152																
1800	182																
2200	222													222			
2700	272																
3300	332	332															
3900	392																
4700	472																
5600	562																
6800	682																
8200	822																
10nF	103			103	103							103					
15	153						153										
22	223																
33	333																
47	473									473							
68	683																
100	104											104	104		104		104
150	154		154														
220	224						224										
330	334														334	334	
470	474			474	474			474									
680	684																
1000	105									105							

MULTI-LAYER CERAMIC CAPACITORS

Radial & Axial

MARKING (PRINT ON THE ONE SIDE)

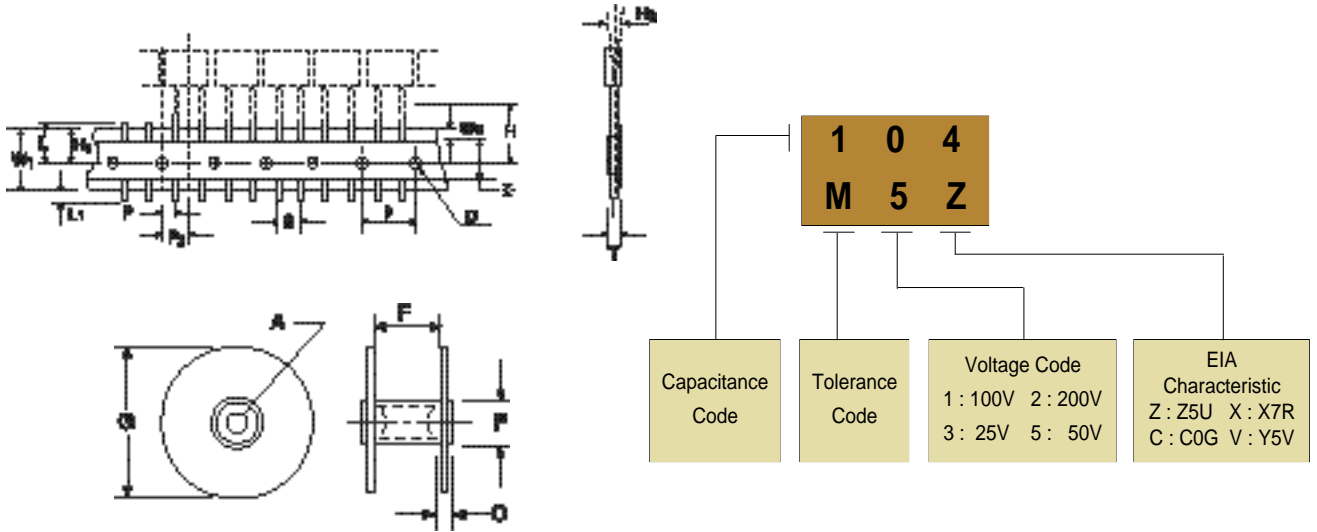

(Unit : mm)

CODE	DIMENSIONS	TOLERANCE	CODE	DIMENSIONS	TOLERANCE	CODE	DIMENSIONS	TOLERANCE
D	3.98	° 0.30	P1	3.86	° 0.71	C	∅ 9.50	min
H	16.00	° 0.50	P2	6.35	° 1.29	E	∅ 29.97-50.04	within range
H1	8.99	° 0.76-0.50	T	0.89	max	F	∅ 34.89-102.00	within range
H2	0.00	° 2.00	W1	18.00	+0.99-0.50	G	∅ 76.20-358.14	within range
L	11.00	max	W2	0.00	6.00 max	S	5.00	° 0.78
L1	1.52	max	A	13.79-38.10	Within range	°	No adhesive may be exposed	
P	12.70	° 0.30	B	28.57-86.00	Within range	∅		

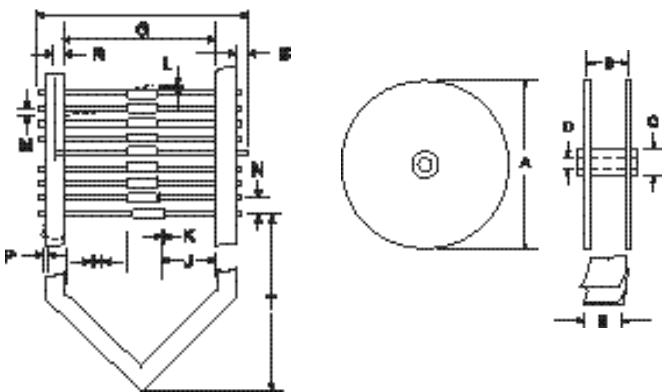

(Unit : mm)

CODE	F		G	
PACKING TYPE	52	26	52	26
DIMENSION	64.8	38.8	52	26
TOLERANCE	+2.0 -0		° 1.25	

(Unit : mm)

CODE	DIMENSIONS	TOLERANCE	CODE	DIMENSIONS	TOLERANCE	CODE	DIMENSIONS	TOLERANCE
A	356.00	max	H	=J	° 1.20	N	5.00	° 0.40
B	F+3.17~F+6.35	Within range	J	=H	° 1.20	P	0.80	max
C	35.70		K	0.80	max	R	3.20	min
D	15.90		L	1.20	max	S	1.60	max
E	63.50		M	1.20	max	T	610.00	min