

Dual 150/300mA LDO with POR

DESCRIPTION

The EUP7212 is a dual low dropout linear regulator. The first regulator is capable of sourcing 150mA, while the second regulator can source up to 300mA and includes a power-on reset function.

The EUP7212 is stable with small ceramic output capacitors. The performance of EUP7212 is optimized for battery power systems to deliver low noise, low dropout voltage, low quiescent current and excellent line and load transient response.

The EUP7212 is available in fixed output voltages in the 8-pin 3mmx3mm DFN leadless package.

FEATURES

- Input Voltage Range: 2.5V to 5.5V
- Stable with Ceramic Output Capacitor
- 2 LDO Outputs:
 - Output 1-150mA Output Current
 - Output 2-300mA Output Current
- Power-on Reset Function with Adjustable Delay Time
- Low Dropout Voltage of 100mV@150mA
- Low Quiescent Current of 150µA
- High PSRR 70dB at 1kHz:
- Thermal Shutdown Protection
- Current Limit Protection
- 3mmx3mm DFN-8 Package
- RoHS Compliant and 100% Lead (Pb)-Free

APPLICATIONS

- Cellular Phones
- Wireless Modems
- PDAs

Typical Application

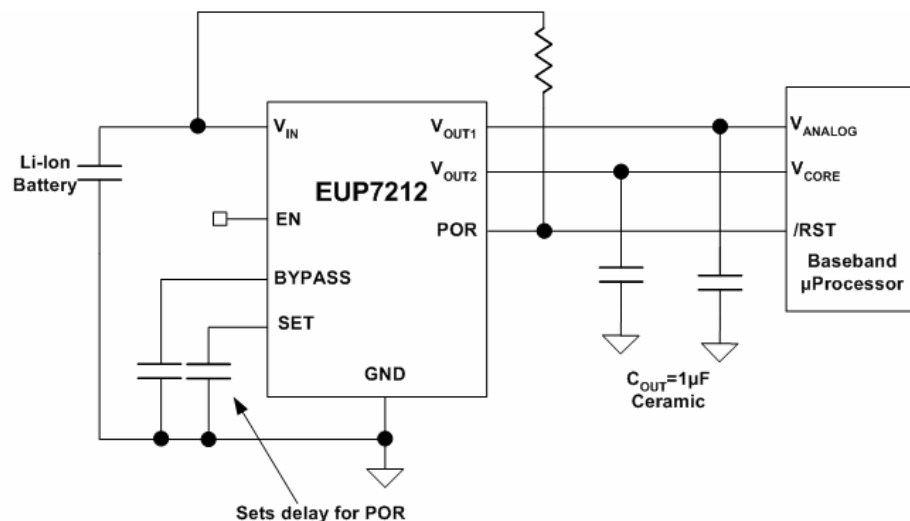

Block Diagram

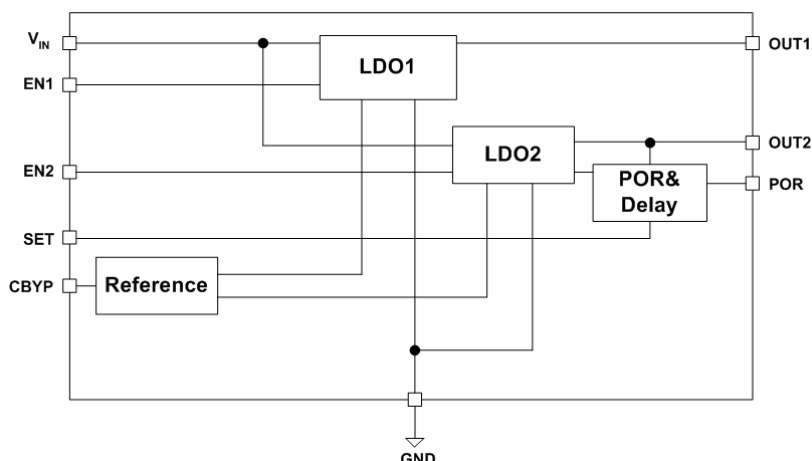

Pin Configurations

Part Number	Pin Configurations
EUP7212 DFN-8	

Pin Description

PIN	Pin	DESCRIPTION
V_{IN}	1	Input voltage of the LDO
EN	2	Enable input: Enables to regulator 1 outputs. Active high input. High=on, low=off. Do not leave floating.
BYPASS	3	Optional bypass capacitor for noise reduction
SET	4	Delay Set Input: Connect external capacitor to GND to set the internal delay for the POR output. When left open, there is no delay. This pin cannot be grounded
GND	5	Ground
POR	6	Power-On Reset Output: Open-Drain Output. Active low indicates an output undervoltage condition on regulator 2
VOUT2	7	Output of regulator 2: 300mA output current
VOUT1	8	Output of regulator 1: 150mA output current

Ordering Information

Order Number	Package Type	Marking	Operating Temperature range
EUP7212-1.8/2.8JIR1	DFN-8	DEXX P7212	-40 °C to 125°C
EUP7212-1.8/2.8JIR0	DFN-8	DEXX P7212	-40 °C to 125°C
EUP7212-3.3/1.8JIR1	DFN-8	HDXX P7212	-40 °C to 125°C
EUP7212-3.3/1.8JIR0	DFN-8	HDXX P7212	-40 °C to 125°C

EUP7212

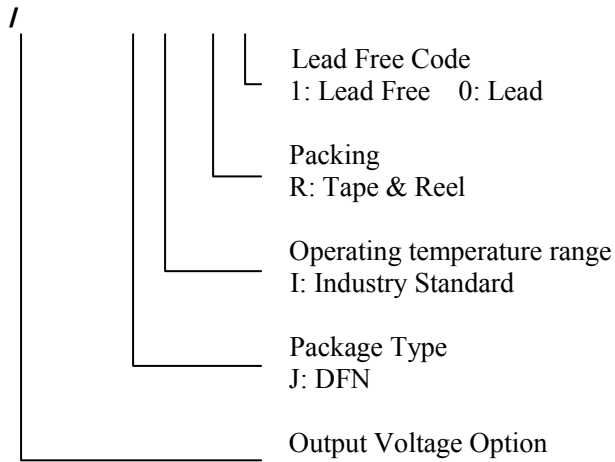

Absolute Maximum Ratings

- V_{IN}, V_{EN} ----- 0V to 7V
- Power Dissipation (P_D) ----- Internally Limited
- Junction Temperature ----- -40°C to $+125^{\circ}\text{C}$
- Storage Temperature ----- -65°C to $+150^{\circ}\text{C}$
- Lead Temp ----- 260°C

Operating Ratings

- V_{IN} ----- 2.5 to 5.5V
- V_{EN} ----- 0V to V_{IN}
- Junction Temperature ----- -40°C to $+125^{\circ}\text{C}$
- Thermal Resistance θ_{JA} (DFN-8) ----- $60^{\circ}\text{C}/\text{W}$

Electrical Characteristics

$V_{IN} = V_{OUT} + 1.0\text{V}$, $I_{OUT} = 1\text{mA}$, $C_{OUT} = 1\mu\text{F}$. Typical values and limits appearing in standard typeface are for $T_J = 25^{\circ}\text{C}$

Symbol	Parameter	Conditions	Min	Typ	Max	Units
V_{OUT}	Output Voltage Accuracy	Variation from nominal Vout	-1.5		1.5	%
Reg Line	Line Regulation	Input range $V_{in} = V_{out} + 1\text{V}$ to 5.5V	-0.2	0.02	0.2	%/V
Reg Load	Load Regulation	$I_{out} = 100\mu\text{A}$ to 150mA (Vout 1 & Vout 2)		0.7	2	%
		$I_{out} = 100\mu\text{A}$ to 300mA (Vout)		1	2.5	
V_{Drop}	Dropout Voltage	$I_{out} = 150\text{mA}$ (Vout 1)		120	180	mV
		$I_{out} = 300\text{mA}$ (Vout 2)		240	350	
I_Q	Ground Pin Current	$I_{out1} = I_{out2} = 0$		150	170	μA
		$I_{out1} = 150\text{mA}$ & $I_{out} = 300\text{mA}$		250	300	
I_{Q_SD}	Ground Pin Current in Shutdown	$V_{EN} = 0.4\text{V}$		3	5	μA
PSRR	Ripple Rejection	Freq.=1KHz; $C_{out} = 1.0\mu\text{F}$; $C_{BYP} = 10\text{nF}$		70		dB
$I_{out}(\text{Max})$	Current Limit	Output 1 Short to Ground	150	340		mA
		Output 2 Short to Ground	300	580		
Noise	Output Voltage Noise	$C_{out} = 1.0\mu\text{F}$; $C_{BYP} = 10\text{nF}$; $BW = 10 \sim 100\text{KHz}$		40		μV_{rms}
Enable Input						
V_{EN}	Enable Input voltage	Logic Low (Regulator Shutdown)			0.6	V
		Logic High (Regulator Enable)	1.8			
I_{EN}	Enable Input Current	$V_{IL} < 0.6\text{V}$ (Regulator Shutdown)	-0.5	0.01	0.5	μA
		$V_{IH} > 1.8\text{V}$ (Regulator Enable)	-0.5	0.01	0.5	
POR Output						
V_{TH}	Low Threshold	Low Threshold, % of nominal Vout 2 (Flag ON)	90			%
	High Threshold	High Threshold, % of nominal Vout 2 (Flag OFF)			96	%
V_{OL}	POR output logic low voltage;	$I_L = 250\mu\text{A}$		0.17	0.2	V
I_{POR}	Flag leakage Current	Flag OFF	-1	0.01	1	μA
SET Input						
I_{SET}	SET Pin Current Source	Set pin Voltage to 0	0.75	1.25	1.75	μA
V_{SET}	SET Pin Threshold Voltage	POR = High		1.25		V

Typical Operating Characteristics

Unless otherwise specified, $C_{IN}=C_{COUT}=1\mu F$ Ceramic, $C_{BYPASS}=100nF$, $V_{IN}=V_{OUT}+1V$, $I_{OUT}=100\mu A$ $T_A=25^\circ C$, Enable pin is tied to V_{IN} .

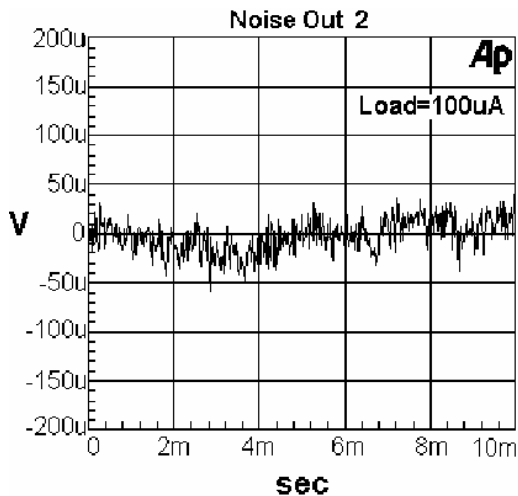
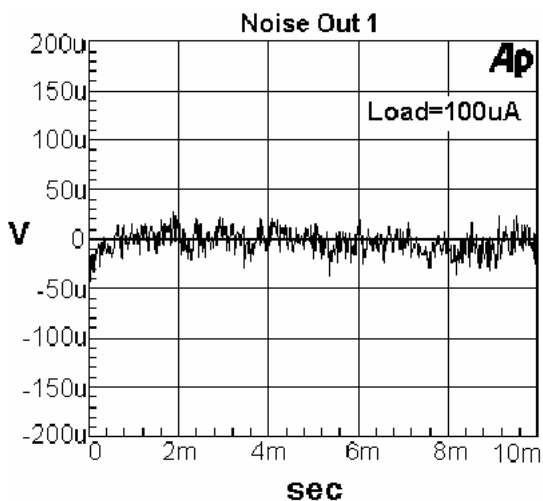
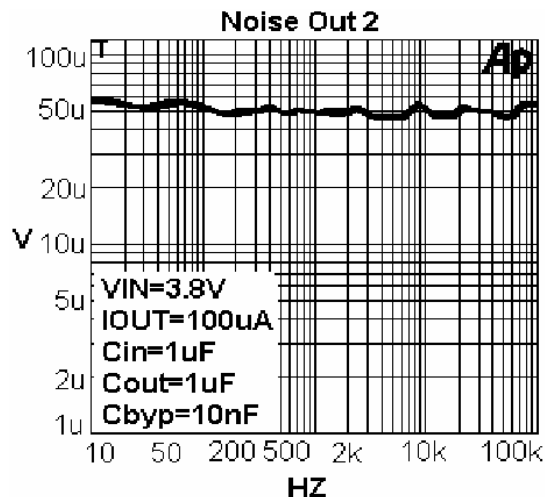
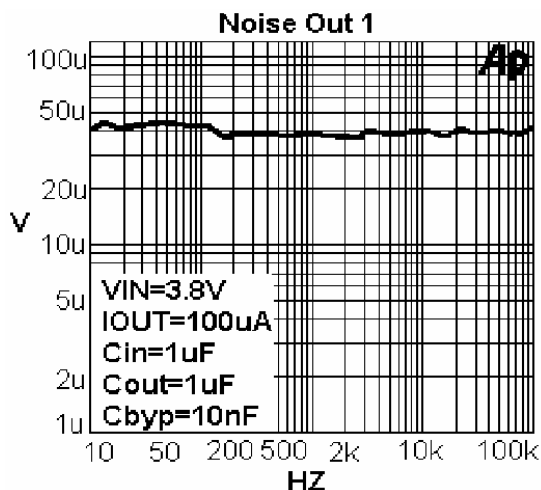
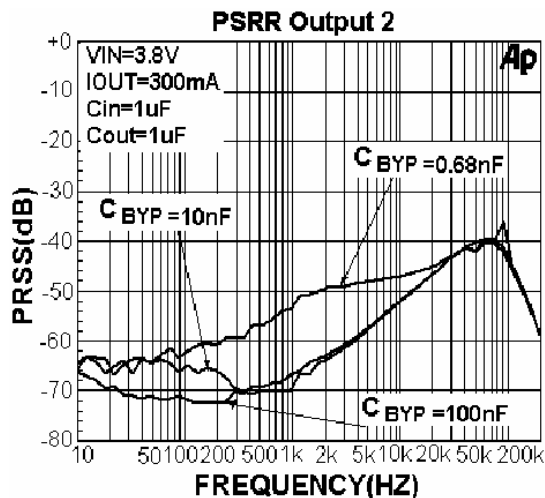
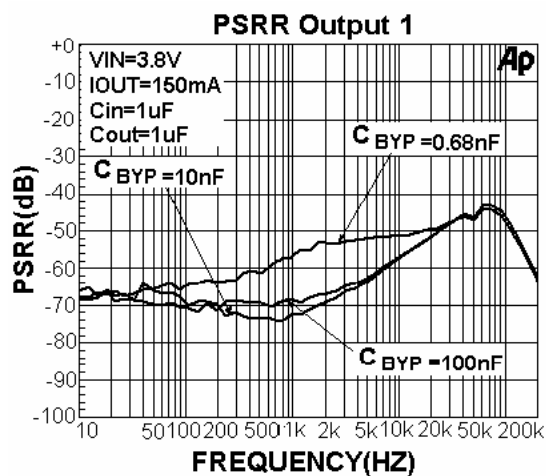

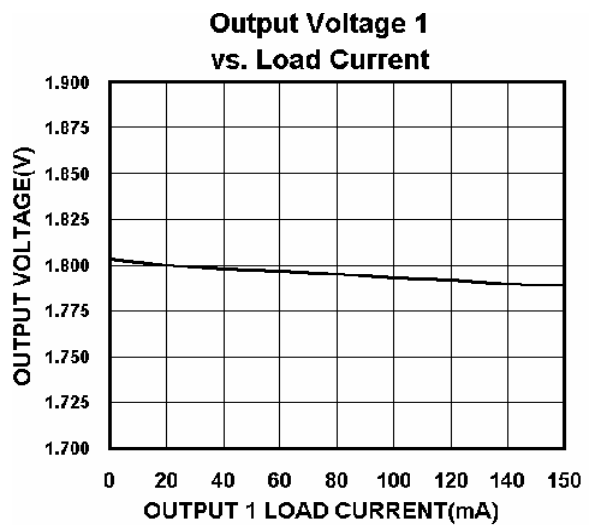
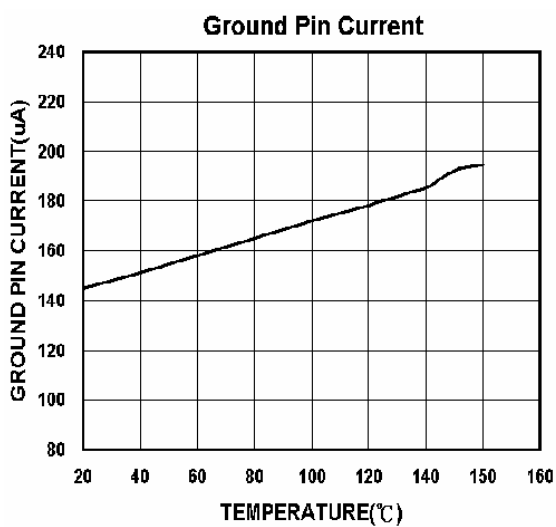
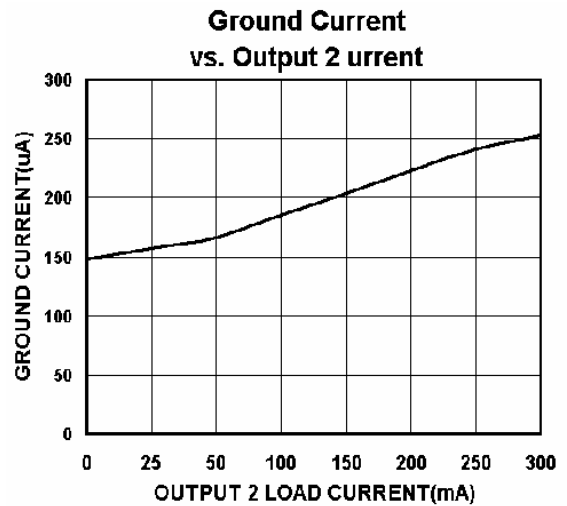
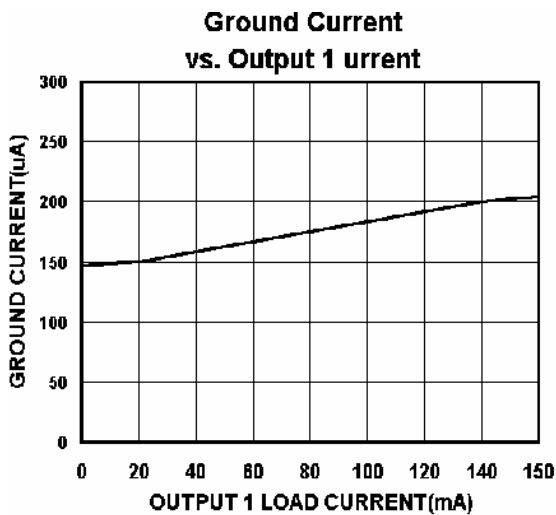
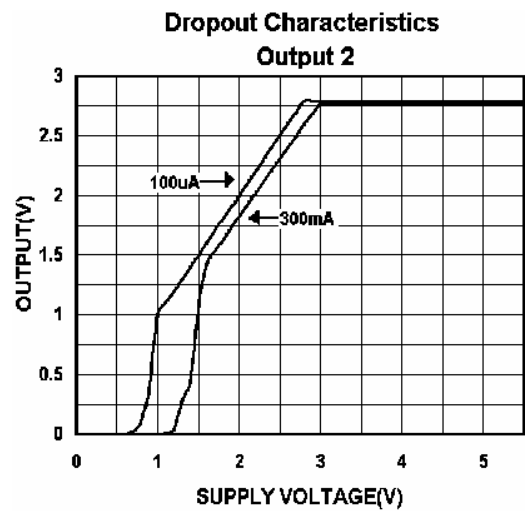
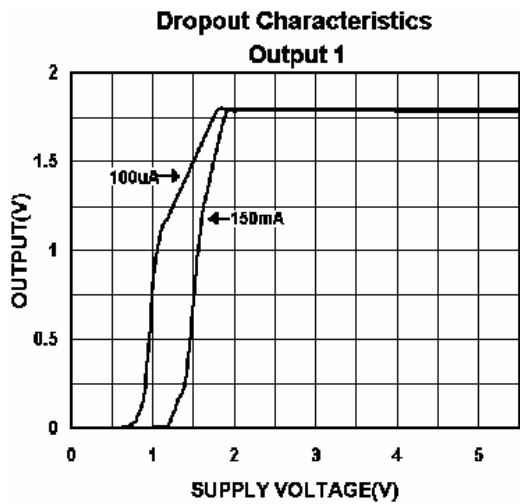

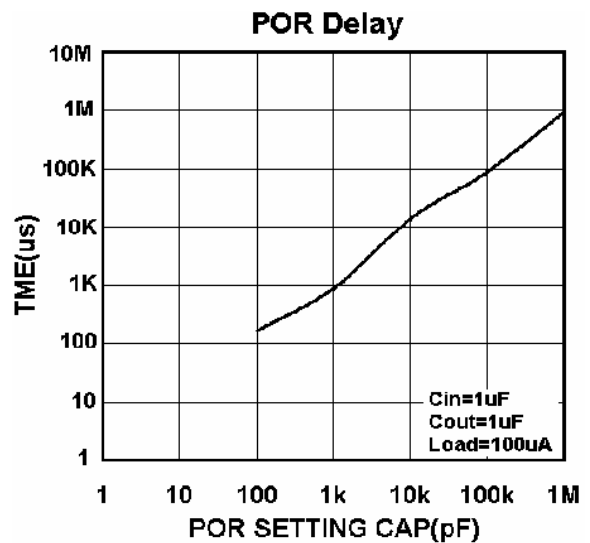
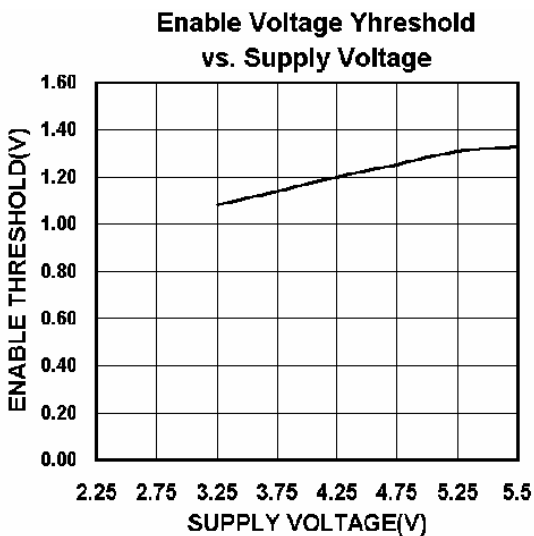
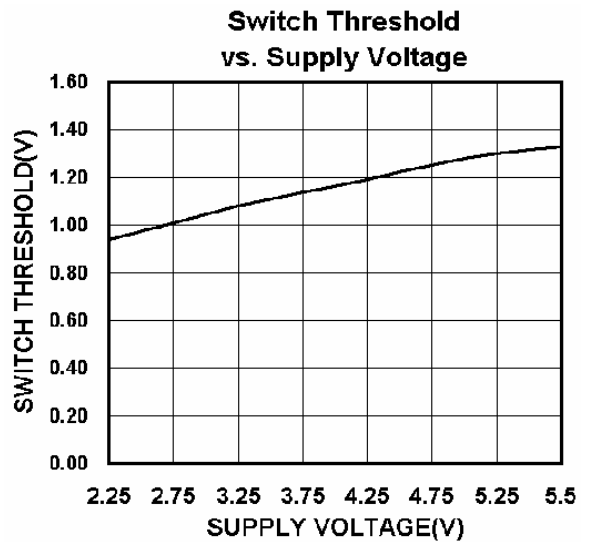
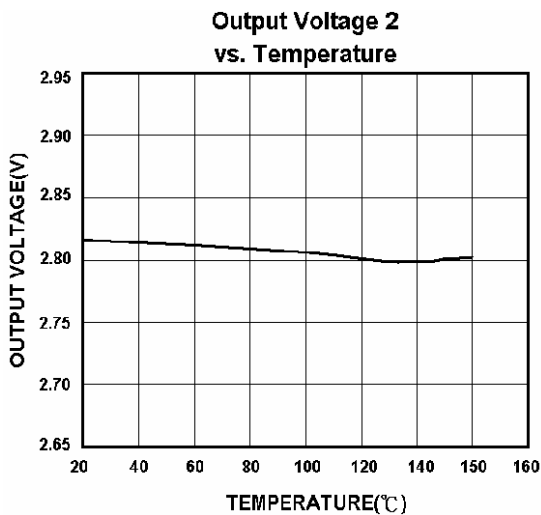
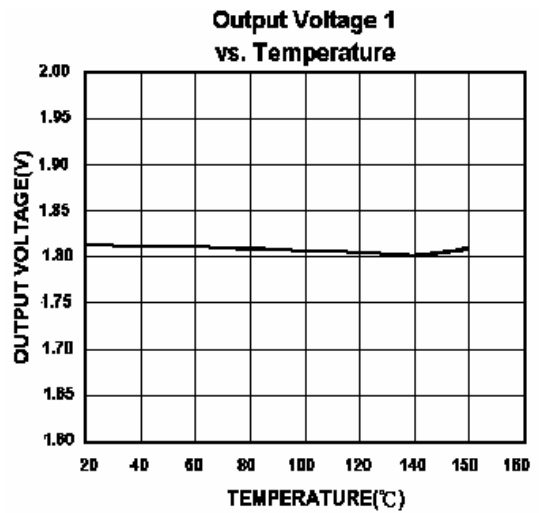
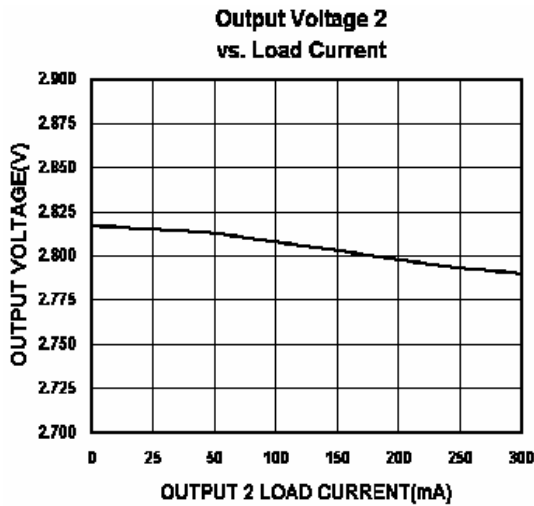

Enable Characteristic

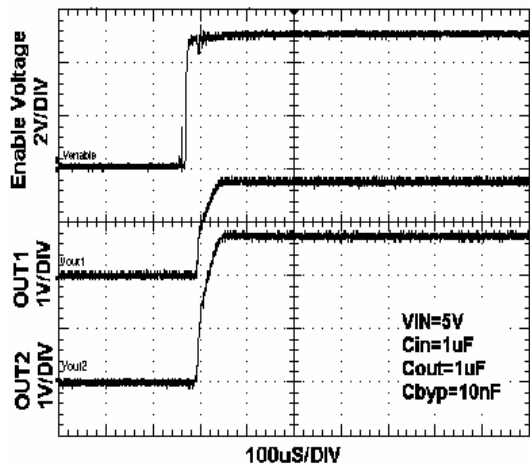

Power - On Reset Characteristics

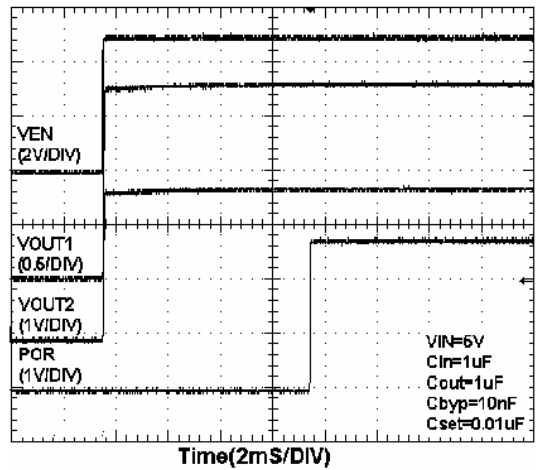

LINE TRANSIENT RESPONSE OUT1

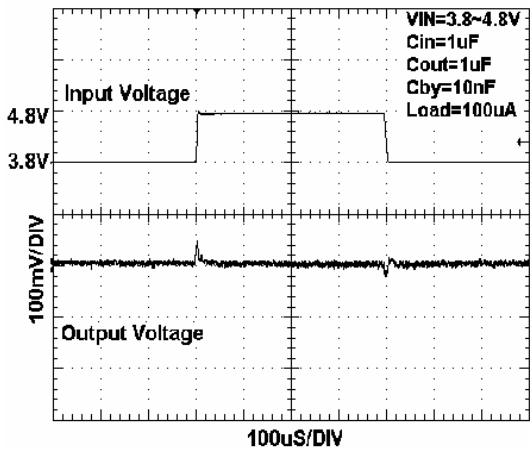

LINE TRANSIENT RESPONSE OUT2

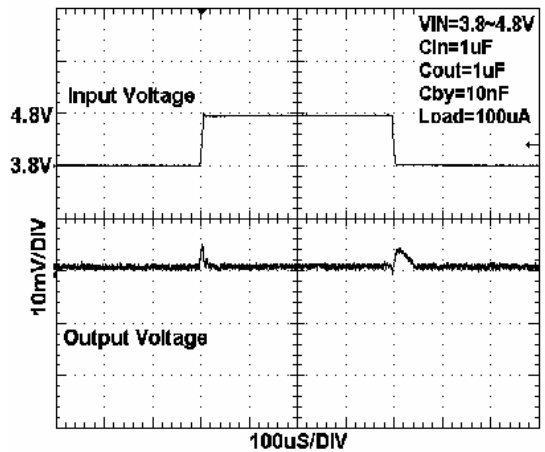

CURRENT LIMIT OUT1

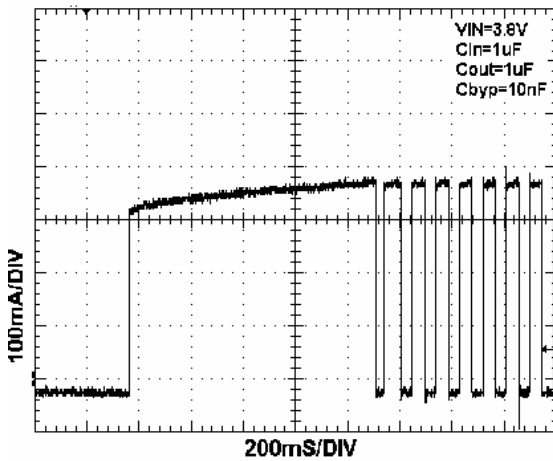

CURRENT LIMIT OUT2

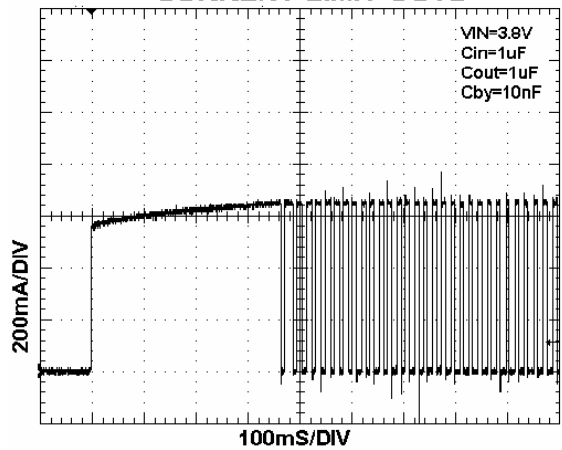

Application Note

Function Description

The EUP7212 is a high performance, low quiescent current power management IC consisting of two μ Cap low dropout regulators, a power-on reset (POR) circuit and an open-drain driver. The first regulator is capable of sourcing 150mA at output voltages from 1.25V to 5V. The second regulator is capable of sourcing 300mA of current at output voltages from 1.25V to 5V. The second regulator has a POR circuit that monitors its output voltage and indicates when the output voltage is within 5% of nominal. The POR offers a delay time that is externally programmable with a single capacitor to ground. An open-drain driver completes the power management chipset, offering the capability of driving LEDs for keypad backlighting in applications such as cellphones.

Enable

The enable input allows for logic control of both output voltages with one enable input. The EUP7212 is turned off by pulling the V_{EN} pin low, and turned on by pulling it high. If this feature is not used, the V_{EN} pin should be tied to V_{IN} to keep the regulator output on at all time. To assure proper operation, the signal source used to drive the V_{EN} input must be able to swing above and below the specified turn-on/off voltage thresholds listed in the Electrical Characteristics section under V_{IL} and V_{IH} .

Power-On Reset (POR)

The power-on reset output is an open-drain N-Channel device, requiring a pull-up resistor to either the input voltage output voltage for proper voltage for proper voltage levels. The POR output has a delay time that is programmable with a capacitor from the SET pin to ground. The delay time can be programmed to be as long as 1 second.

The SET pin is a current source output that charges a capacitor that sets the delay time for the power-on reset output. The current source is a 1 μ A current source that charges a capacitor up from 0V. When the capacitor reaches 1.25V, the output of the POR is allowed to go high.

External Capacitors

Like any low-dropout regulator, the EUP7212 requires external capacitors for regulator stability. The EUP7212 is specifically designed for portable applications requiring minimum board space and smallest components. These capacitors must be correctly selected for good performance.

Input Capacitor

An input capacitance of $\approx 1\mu$ F or greater is required between the EUP7212 input pin and ground (the amount of the capacitance may be increased without limit).

This capacitor must be located a distance of not more than 1cm from the input pin and returned to a clean analog ground. Any good quality ceramic, tantalum, or film capacitor may be used at the input.

Output Capacitor

The EUP7212 is designed specifically to work with very small ceramic output capacitors. A ceramic capacitor (temperature characteristics X7R, X5R, Z5U, or Y5V) in 1 to 22 μ F range with 5m Ω to 500m Ω ESR range is suitable in the EUP7212 application circuit.

The output capacitor must meet the requirement for minimum amount of capacitance and also have an ESR (Equivalent Series Resistance) value which is within a stable range (5m Ω to 500m Ω)

No-Load Stability

The EUP7212 will remain stable and in regulation with no external load. This is specially important in CMOS RAM keep-alive applications.

Capacitor Characteristics

The EUP7212 is designed to work with ceramic capacitors on the output to take advantage of the benefits they offer: for capacitance values in the range of 1 μ F to 4.7 μ F range, ceramic capacitors are the smallest, least expensive and have the lowest ESR values (which makes them best for eliminating high frequency noise). The ESR of a typical 1 μ F ceramic capacitor is in the range of 20m Ω to 40m Ω , which easily meets the ESR requirement for stability by the EUP7212.

The ceramic capacitor's capacitance can vary with temperature. The capacitor type X7R, which operates over a temperature range of -55 $^{\circ}$ C to +125 $^{\circ}$ C, will only vary the capacitance to within $\pm 15\%$. Most large value ceramic capacitors ($\approx 2.2\mu$ F) are manufactured with Z5U or Y5V temperature characteristics. Their capacitance can drop by more than 50% as the temperature goes from 25 $^{\circ}$ C to 85 $^{\circ}$ C. Therefore, X7R is recommended over Z5U and Y5V in applications where the ambient temperature will change significantly above or below 25 $^{\circ}$ C.

Noise Bypass Capacitor

Connecting a 0.01 μ F capacitor between the C_{BYPASS} pin and ground significantly reduces noise on the regulator output. This cap is connected directly to a high impedance node in the bandgap reference circuit. Any significant loading on this node will cause a change on the regulated output voltage. For this reason, DC leakage current through this pin must be kept as low as possible for best output voltage accuracy. The types of capacitors best suited for the noise bypass capacitor are ceramic and film.

Unlike many other LDO's, addition of a noise reduction capacitor does not effect the load transient response of the device.

Packaging Information

DFN-8

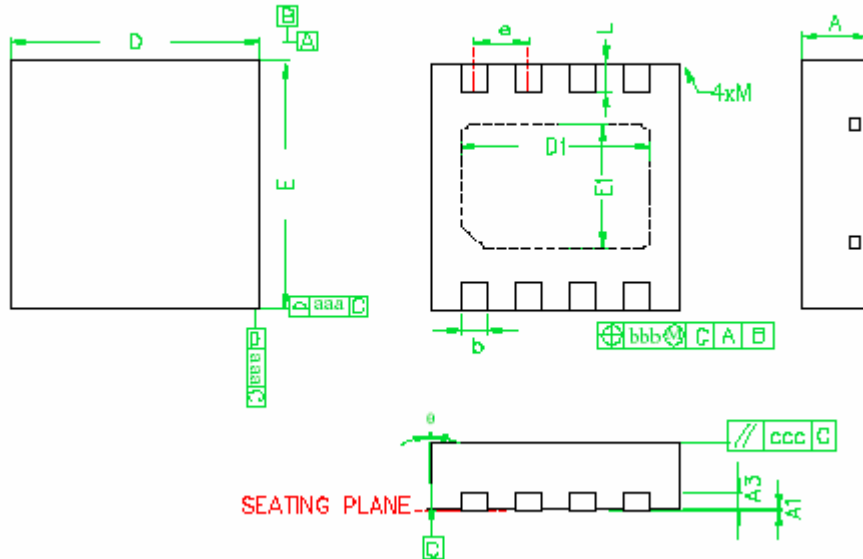

NOTE

1. All dimensions are in millimeters, θ is in degrees
2. M: The maximum allowable corner on the molded plastic body corner
3. Dimension D does not include mold protrusions or gate burrs. Mold protrusions and gate burrs shall not exceed 0.15mm per side
4. Dimension E does not include interterminal mold protrusions or terminal protrusions. Interterminal mold protrusions and/or terminal protrusions shall not exceed 0.20mm per side
5. Dimension b applies to plated terminals. Dimension A1 is primarily Y terminal plating, but may or may not include a small protrusion of terminal below the bottom surface of the package
6. Burr shall not exceed 0.060mm
7. JEDEC MO-229

SYMBOLS	DIMENSIONS IN MILLIMETERS		
	MIN.	NOM.	MAX.
A	0.81	0.9	1.00
A1	0	0.015	0.03
A3	-----	0.20 REF	-----
B	0.25	0.30	0.37
D	2.85	3.00 BSC	3.15
D1	-----	2.3 BSC	-----
E	2.85	3.00 BSC	3.15
E1	-----	1.5 BSC	-----
e	-----	0.65 BSC	-----
L	0.25	0.35	0.45
aaa	-----	0.25	-----
bbb	-----	0.10	-----
ccc	-----	0.10	-----
M	-----	-----	0.05
θ	-12	-----	0