

Low Voltage Adjustable Precision Shunt Regulator

Features

- Precise Reference Voltage to 1.24V
- Guaranteed 0.5% or 1% Reference Voltage Tolerance
- Sink Current Capability, 80uA to 100mA
- Quick Turn-on
- Adjustable Output Voltage, $V_o = V_{REF}$ to 20V
- Low Operational Cathode Current, 80μA Typical
- 0.1Ω Typical Output Impedance
- SOT-23-3, SOT-23-5, TO-92 and SOT-89 Packages
- Lead Free Available (RoHS Compliant)

Applications

- Linear Regulators
- Adjustable Power Supply
- Switching Power Supply

Symbol

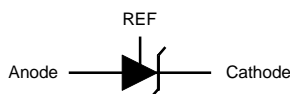

General Description

The APL431L is a 3-terminal low voltage adjustable precision reference with specified thermal stability over applicable commercial temperature ranges. Output voltage may be set to any value between V_{ref} (1.24 V) and 20 V with two external resistors (see Figure 2). When used with an photocoupler, the APL431L is an ideal voltage reference in isolated feedback circuits for 3V to 12V switching-mode power supplies. This device has a typical output impedance of 0.1Ω. Active output circuitry provides a very sharp turn-on characteristic, making the APL431L excellent replacements for zener diodes in many applications, including on-board regulation and adjustable power supplies.

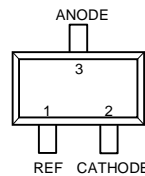

SOT-23-3 (Top View)

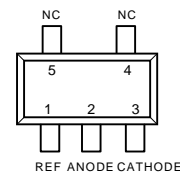

SOT-23-5 (Top View)

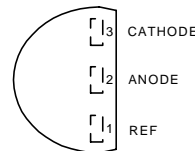

TO-92 (Top View)

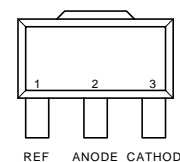

SOT-89 (Top View)

Functional Diagram

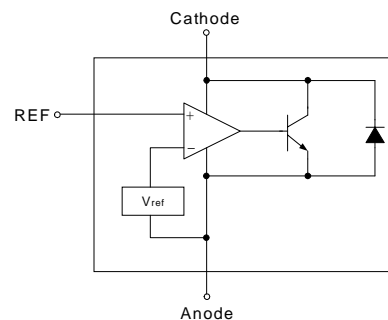

ANPEC reserves the right to make changes to improve reliability or manufacturability without notice, and advise customers to obtain the latest version of relevant information to verify before placing orders.

Ordering and Marking Information

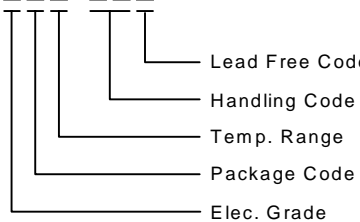
<p>APL431L □□□-□□□</p>  <p>Lead Free Code Handling Code Temp. Range Package Code Elec. Grade</p>	<p>Elec. Grade A : 0.5% Reference Voltage Tolerance B : 1% Reference Voltage Tolerance</p> <p>Package Code A : SOT-23-3 B : SOT-23-5 D : SOT-89 E : TO-92 Y:Chip Form</p> <p>Temp. Range C : 0 to 70 °C I : -40 to 85 °C</p> <p>Handling Code PB : Plastic Bag TB : Tape & Box TR : Tape & Reel</p> <p>Lead Free Code L : Lead Free Device Blank : Original Device</p>
<p>APL431L A/B : 431L</p>	<p>APL431L E : APL 431L XXXXX XXXXX - Date Code</p>
<p>APL431L D : APL431L XXXXX XXXXX - Date Code</p>	

Notes : ANPEC lead-free products contain molding compounds/die attach materials and 100% matte in plate termination finish; which are fully compliant with RoHS and compatible with both SnPb and lead-free soldering operations. ANPEC lead-free products meet or exceed the lead-free requirements of IPC/JEDEC J STD-020C for MSL classification at lead-free peak reflow temperature.

Absolute Maximum Ratings

Symbol	Parameter	Rating	Unit
V_{KA}	Cathode voltage	20	V
I_K	Continuous cathode current range	100	mA
I_{REF}	Reference current range	3	mA
θ_{JA}	Thermal Resistance from Junction to Ambient in Free Air		°C/W
	SOT-23-3	416	
	SOT-23-5	357	
	SOT-89	250	
	TO-92	250	
T_J	Operating Junction Temperature Range	-40 to 150	°C
T_{STG}	Storage Temperature Range	-65 to 150	°C
T_{SOL}	Lead temperature range, T_s (Soldering, 10sec)	260	°C

Electrical Characteristics $T_A = 25^\circ\text{C}$ (unless otherwise noted)

Symbol	Parameter	Test Conditions	APL431L			Unit	
			Min.	Typ.	Max.		
V_{REF}	Reference voltage	$V_{KA}=V_{REF}, I_K=10\text{mA}$ $T_A = 25^\circ\text{C}$, (Fig. 1)	APL431LA	1.234	1.240	1.246	V
			APL431LB	1.228	1.240	1.252	
		$T_A = \text{full range (see Note1), (Fig.1)}$	APL431LA	1.222	1.240	1.258	
			APL431LB	1.215	1.240	1.265	
V_{DEF}	V_{DEF} Temp Deviation	$T_A = \text{full range (see Note1)}$ $V_{KA}=V_{REF}, I_K=10\text{mA}$ (Fig. 1)		5	15	mV	
$\Delta V_{REF} / \Delta V_{KA}$	Ratio of Change in V_{REF} to Change in Cathods Votage	$I_K=10\text{mA}, V_{KA}=16\text{V to } V_{REF}$ (Fig. 2)		-0.2	-1.0	mV/V	
I_{REF}	Reference Input Current	$I_K=10\text{mA}, R_1=10\text{k}\Omega, R_2=\infty$ (Fig. 2)		0.15	0.5	μA	
$I_{REF(DEV)}$	I_{REF} Temp Deviation	$T_K=\text{full range (see Note 1),}$ $R_1=10\text{k}\Omega, R_2=\infty, I_K=10\text{mA},$ (Fig. 2)		0.05	0.3	μA	
$I_{K(off)}$	off-state cathode current	$V_{REF}=0\text{V}$, (Fig. 3)	$V_K=6\text{V}$		0.01	0.1	μA
			$V_K=16\text{V}$		0.01	0.5	
Z_{KA}	Dynamic Output Impedance	$V_{KA}=V_{REF}, I_K=1\text{mA to } 100\text{mA},$ $f \leq 1\text{kHz}$ (Fig. 1)		0.1	0.4	Ω	
$I_{K(MIN)}$	Minimum Operating Current	$V_{KA}=V_{REF}$ (Fig. 1)		80	100	μA	

Notes : 1.Full temperature range is 0°C to 70°C for APL431LXXC,and -40°C to 85°C for APL431LXXI.

Test Figures

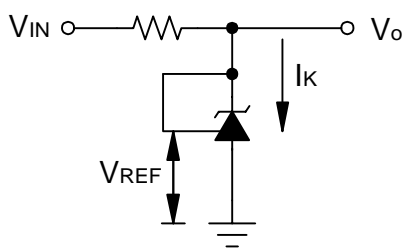

Figure 1. Test Circuit for $V_{KA}=V_{REF}, V_O=V_{KA}=V_{REF}$

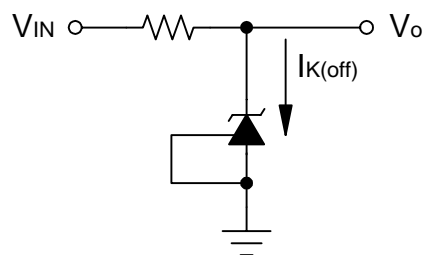

Figure 3. Test Circuit for $I_{K(off)}$

Test Figures (Cont.)

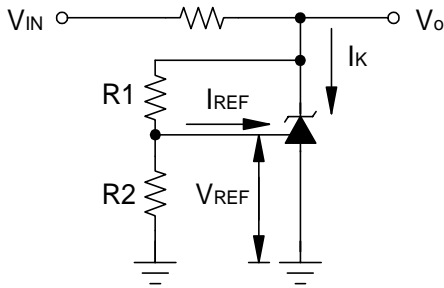
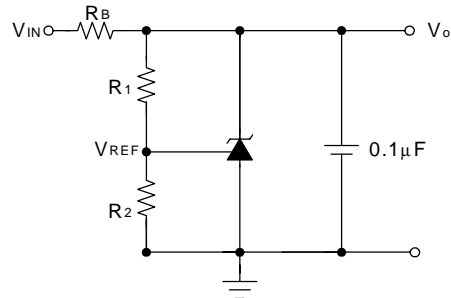

Figure 2. Test Circuit for $V_{KA} > V_{REF}$,
 $V_O = V_{KA} = V_{REF} \times (1 + R_1/R_2) + I_{REF} \times R_1$

Application Schematic

Precision Voltage Reference



Precision High-Current Series Regulator

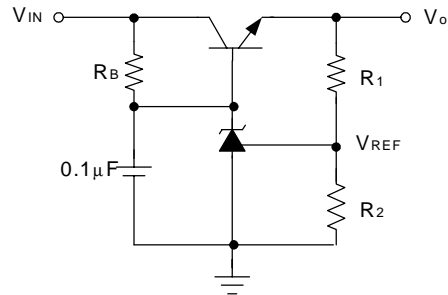

Notes for Application Circuits:

- 1) To improve the stability of output voltage, a 0.1 μF capacitor between cathode and anode of APL431L is strongly recommended.
- 2) Set V_{OUT} according to the following equation:
 $V_{OUT} = V_{REF}(1 + R_1/R_2) + I_{REF} R_1$
- 3) Choose the value for R_B as follows:
 - A) The maximum limit for R_B should be such that the cathode current (I_k) is greater than the minimum operating current (80 μA) at $V_{IN(MIN)}$.

- B) The minimum limit for R_B should be such that the cathode current (I_k) does not exceed 100mA under all load conditions, and the instantaneous turn-on value for I_k does not exceed 150mA. Both of the following conditions must be met:

$$R_{B,Min} \geq \frac{V_{IN(MAX)}}{150mA} \quad (\text{to limit instantaneous turn-on } I_k)$$

$$R_{B,Min} \geq \frac{V_{IN(MAX)} - V_{OUT}}{I_{OUT(MIN)} + 100mA}$$

(to limit I_k under normal operating conditions)

Typical Characteristics

Cathode Current vs. Cathode Voltage

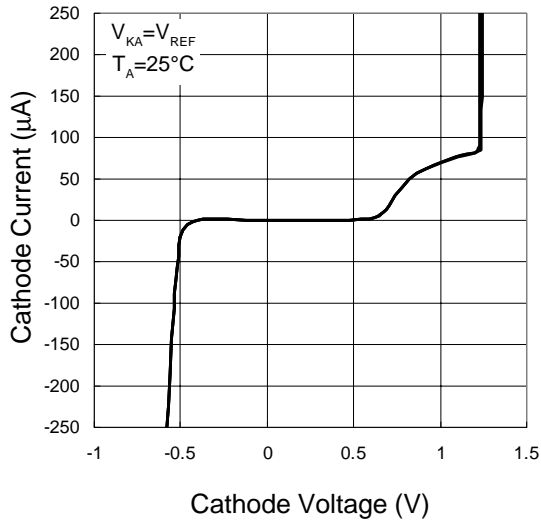

Cathode Current vs. Cathode Voltage

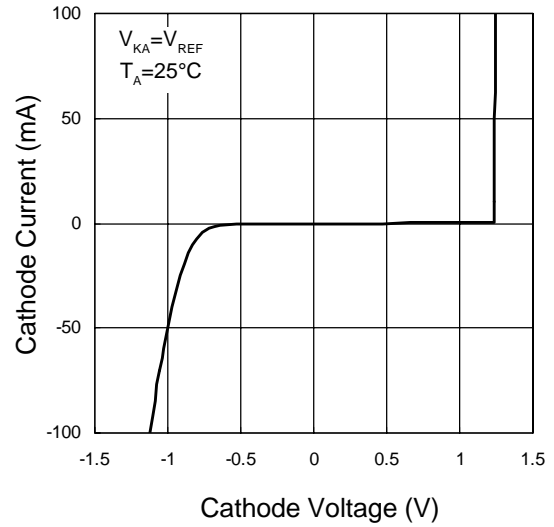

Reference Voltage vs. Junction Temperature

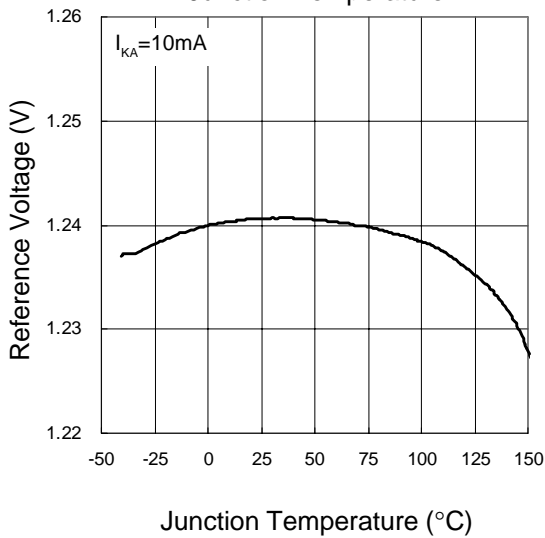

Reference Input Current vs. Junction Temperature

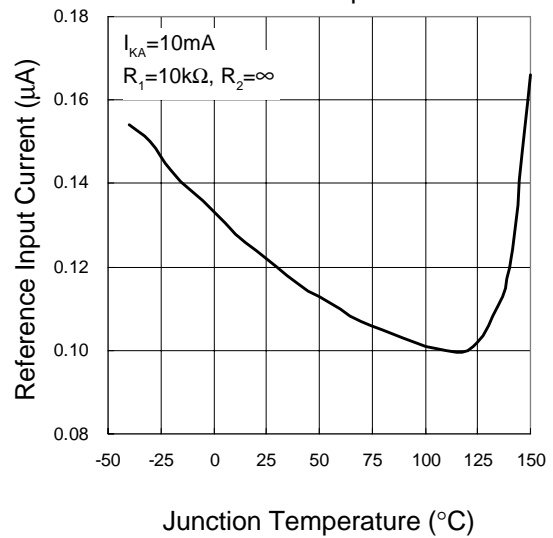

Typical Characteristics

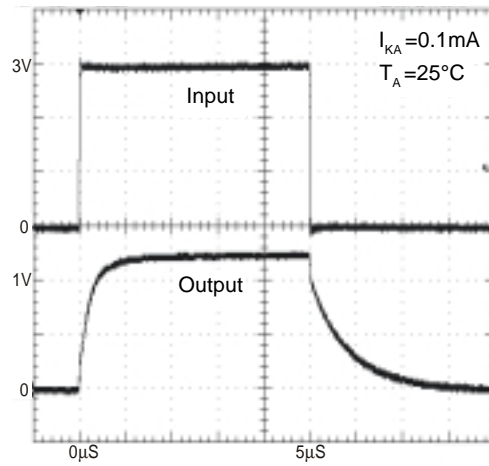
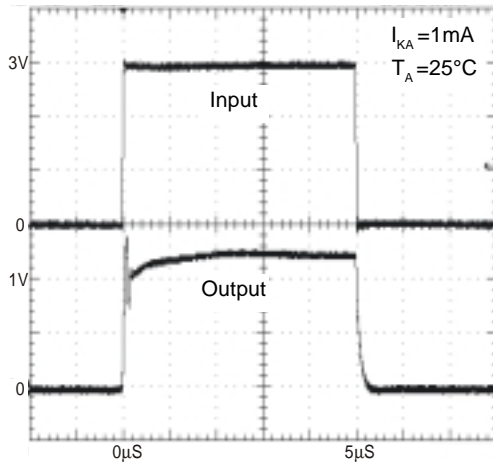
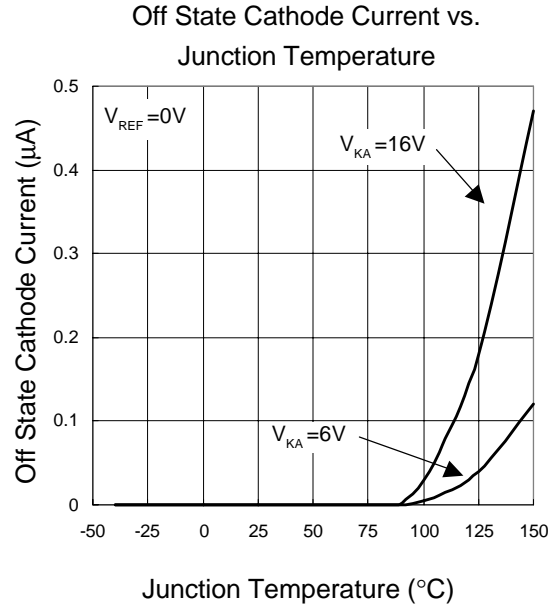
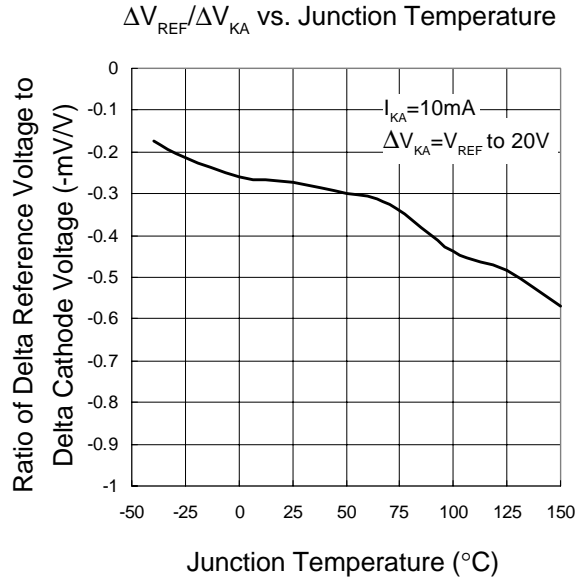

Typical Characteristics

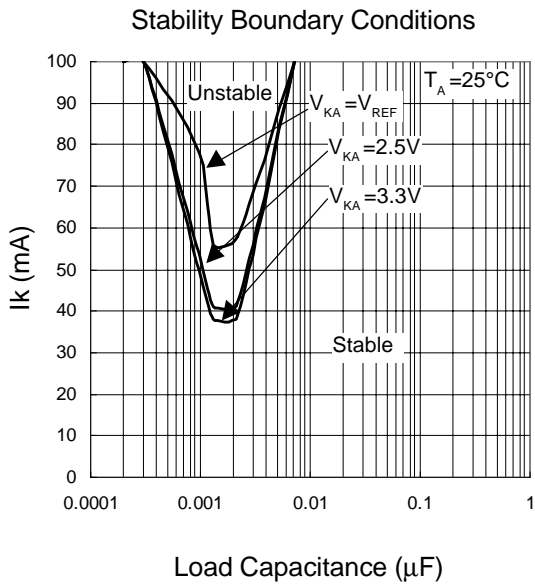
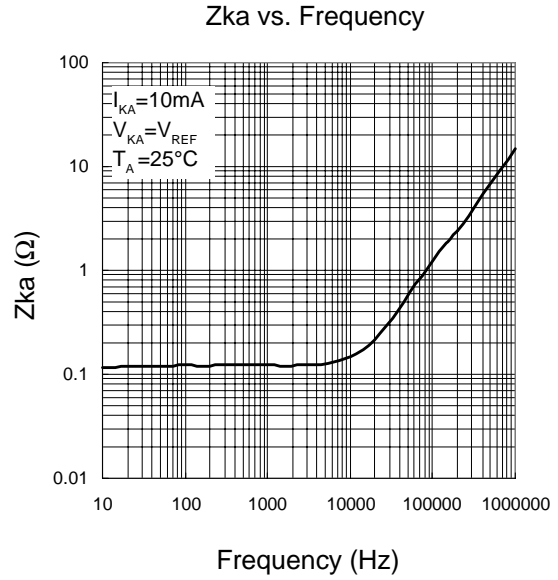
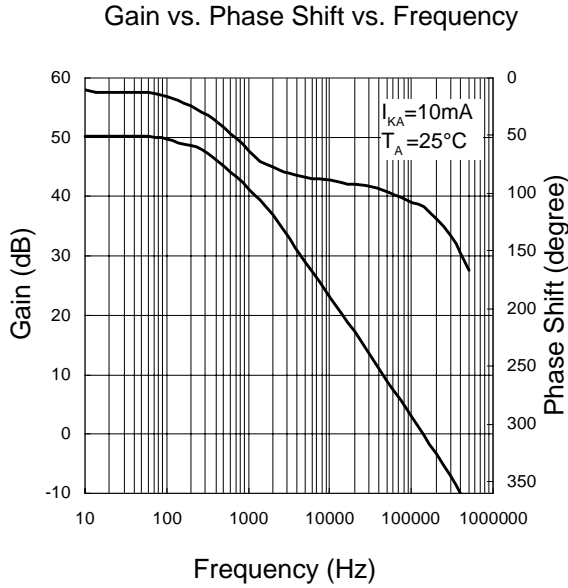

Package Information

SOT-23

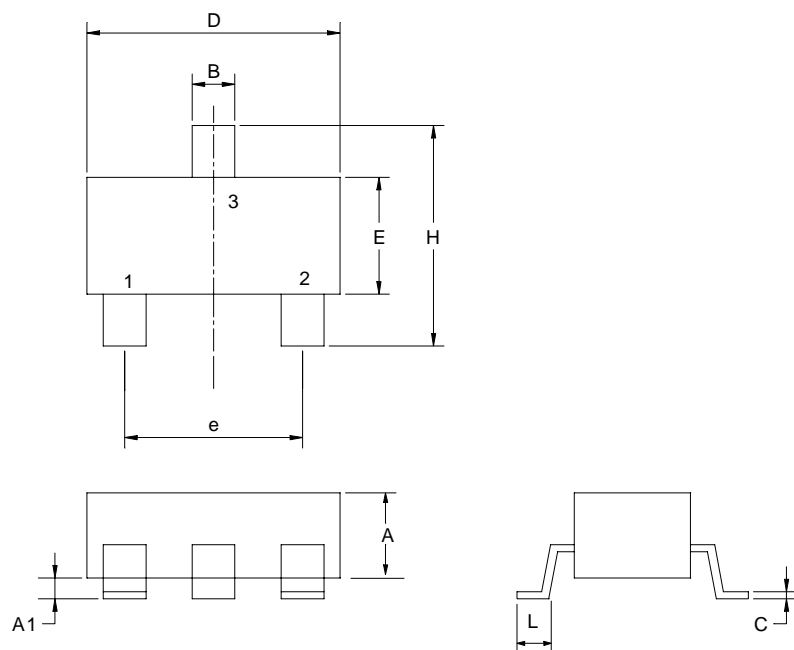

Dim	Millimeters		Inches	
	Min.	Max.	Min.	Max.
A	1.00	1.30	0.039	0.051
A1	0.00	0.10	0.000	0.004
B	0.35	0.51	0.014	0.020
C	0.10	0.25	0.004	0.010
D	2.70	3.10	0.106	0.122
E	1.40	1.80	0.055	0.071
e	1.90/2.1 BSC		0.075/0.083 BSC	
H	2.40	3.00	0.094	0.118
L	0.37		0.015	

Package Information

SOT-23-5

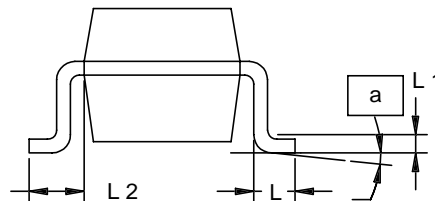
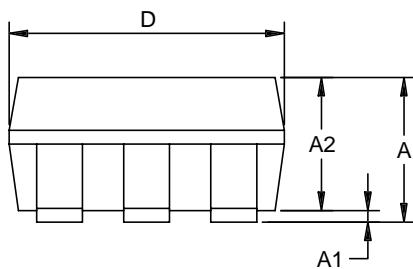
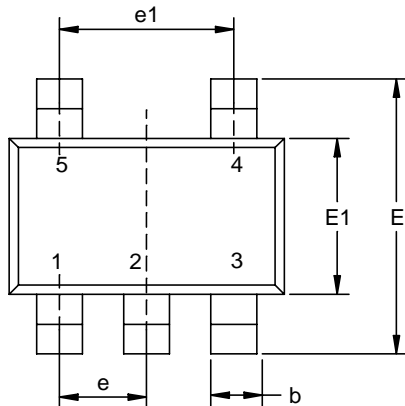

Dim	Millimeters		Inches	
	Min.	Max.	Min.	Max.
A	0.95	1.45	0.037	0.057
A1	0.05	0.15	0.002	0.006
A2	0.90	1.30	0.035	0.051
b	0.30	0.50	0.011	0.019
D	2.8	3.00	0.110	0.118
E	2.6	3.00	0.102	0.118
E1	1.5	1.70	0.059	0.067
e	0.95BSC		0.037BSC	
e1	1.90BSC		0.074BSC	
L	0.35	0.55	0.014	0.022
L1	0.20 BSC		0.008 BSC	
L2	0.5	0.7	0.020	0.028
N	5		5	
α	0°	10°	0°	10°

Package Information

TO-92

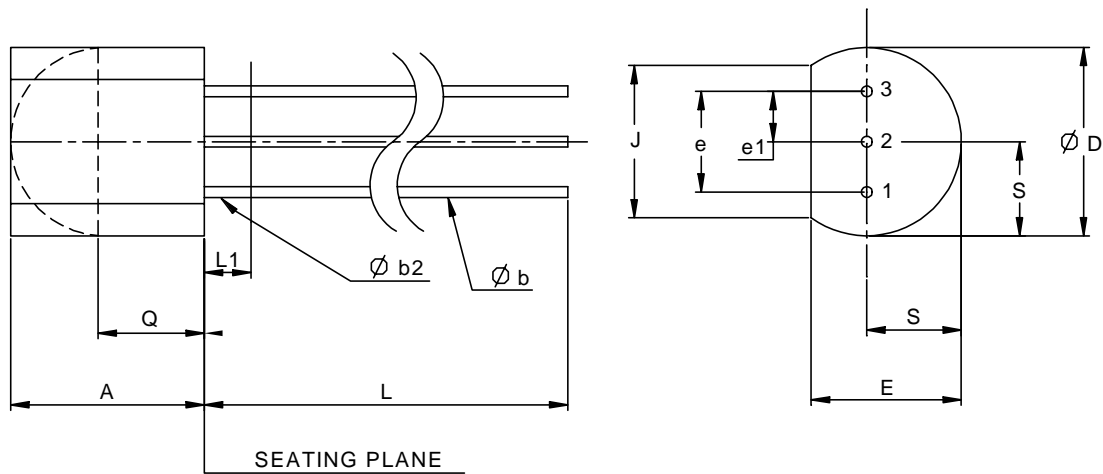

Dim	Millimeters		Inches	
	Min.	Max.	Min.	Max.
A	4.318	5.334	0.170	0.210
φ b	0.406	0.559	0.016	0.022
φ b2	0.406	0.559	0.016	0.022
φ D	4.445	5.207	0.175	0.205
E	3.175	4.191	0.125	0.165
e	2.413	2.667	0.095	0.105
e1	1.143	1.397	0.045	0.055
J	3.429		0.135	
L	12.70		0.500	
L1		1.27		0.050
Q	2.921		0.115	
S	2.032	2.667	0.080	0.105

Package Information

SOT-89 (Reference EIAJ ED-7500A Registration SC-62)

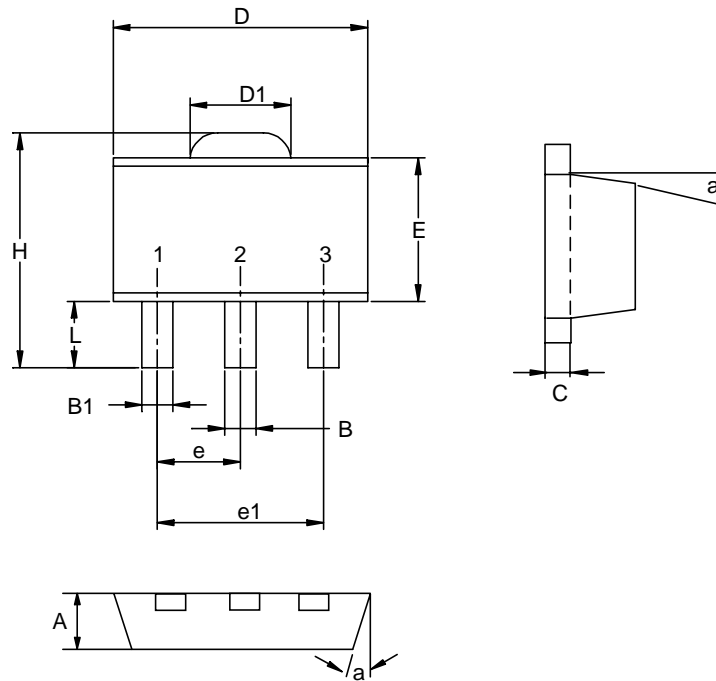

Dim	Millimeters		Inches	
	Min.	Max.	Min.	Max.
A	1.40	1.60	0.055	0.063
B	0.40	0.56	0.016	0.022
B1	0.35	0.48	0.014	0.019
C	0.35	0.44	0.014	0.017
D	4.40	4.60	0.173	0.181
D1	1.35	1.83	0.053	0.072
e	1.50 BSC		0.059 BSC	
e1	3.00 BSC		0.118 BSC	
E	2.29	2.60	0.090	0.102
H	3.75	4.25	0.148	0.167
L	0.80	1.20	0.031	0.047
α		10°		10°

Physical Specifications

Terminal Material	Solder-Plated Copper (Solder Material : 90/10 or 63/37 SnPb), 100%Sn
Lead Solderability	Meets EIA Specification RSI86-91, ANSI/J-STD-002 Category 3.

Reflow Condition (IR/Convection or VPR Reflow)

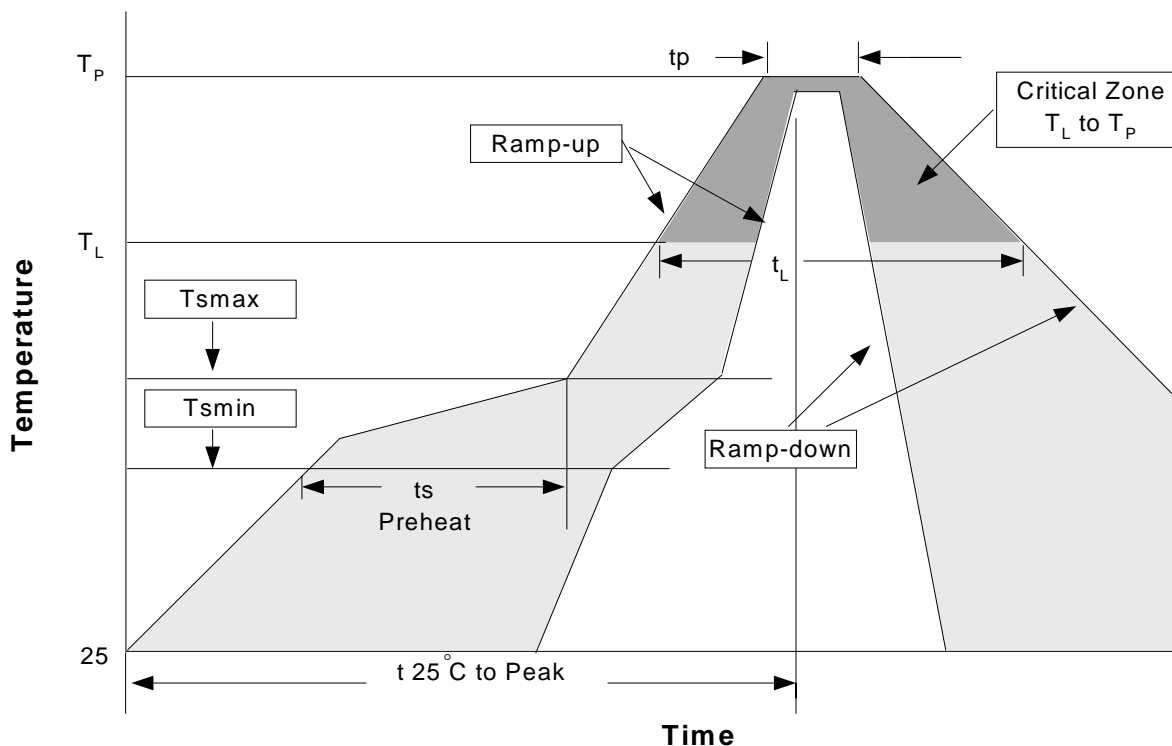

Classification Reflow Profiles

Profile Feature	Sn-Pb Eutectic Assembly		Pb-Free Assembly	
	Large Body	Small Body	Large Body	Small Body
Average ramp-up rate (T_L to T_P)	3°C/second max.		3°C/second max.	
Preheat				
- Temperature Min (T_{smin})	100°C		150°C	
- Temperature Mix (T_{smax})	150°C		200°C	
- Time (min to max)(t_s)	60-120 seconds		60-180 seconds	
T_{smax} to T_L				
- Ramp-up Rate			3°C/second max	
T_{smax} to T_L				
- Temperature(T_L)	183°C		217°C	
- Time (t_L)	60-150 seconds		60-150 seconds	
Peak Temperature(T_p)	225 +0/-5°C	240 +0/-5°C	245 +0/-5°C	250 +0/-5°C
Time within 5°C of actual Peak Temperature(t_p)	10-30 seconds	10-30 seconds	10-30 seconds	20-40 seconds
Ramp-down Rate	6°C/second max.		6°C/second max.	
Time 25°C to Peak Temperature	6 minutes max.		8 minutes max.	

Note: All temperatures refer to topside of the package. Measured on the body surface.

Reliability Test Program

Test item	Method	Description
SOLDERABILITY	MIL-STD-883D-2003	245°C, 5 SEC
HOLT	MIL-STD-883D-1005.7	1000 Hrs Bias @125°C
PCT	JESD-22-B,A102	168 Hrs, 100%RH, 121°C
TST	MIL-STD-883D-1011.9	-65°C~150°C, 200 Cycles
ESD	MIL-STD-883D-3015.7	VHBM > 2KV, VMM > 200V
Latch-Up	JESD 78	10ms, $1_{tr} > 100mA$

Carrier Tape & Reel Dimensions

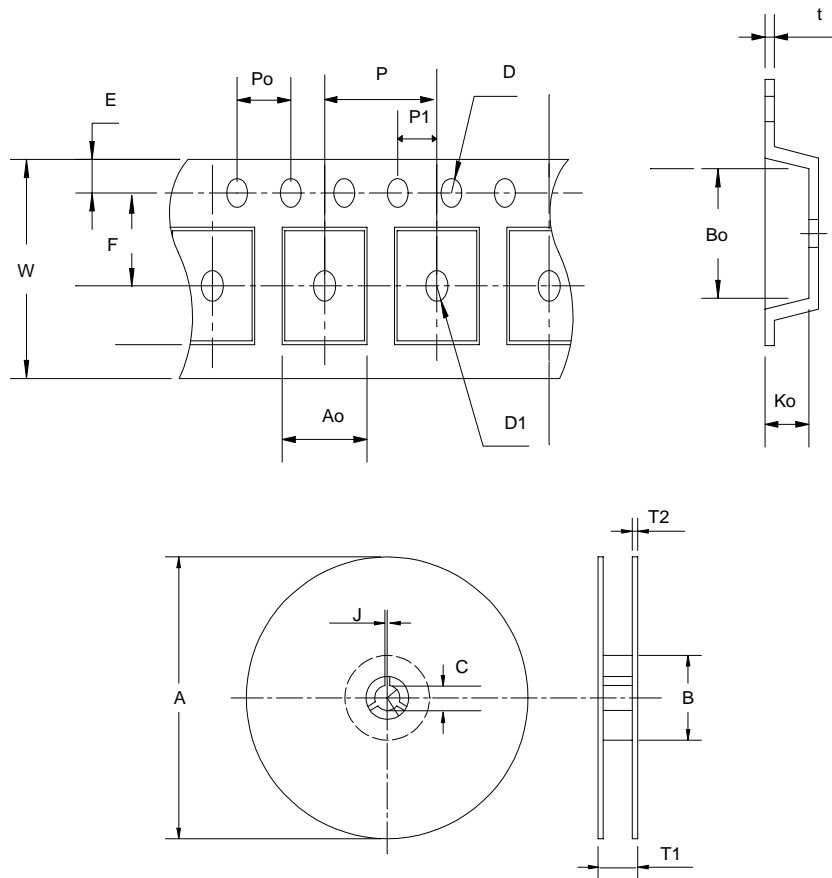

Carrier Tape & Reel Dimensions

Application	A	B	C	J	T1	T2	W	P	E
SOT-89	178±1	70±2	13.5±0.15	3±0.15	14±2	1.3±0.3	12+0.3 12-0.1	8±0.1	1.75±0.1
	F	D	D1	Po	P1	Ao	Bo	Ko	t
	5.5±0.05	1.5±0.1	1.5±0.1	4.0±0.1	2.0±0.1	4.8±0.1	4.5±0.1	1.80±0.1	0.3±0.013
Application	A	B	C	J	T1	T2	W	P	E
SOT-23	178±1	60±1.0	12.0	2.5±0.15	9.0±0.5	1.4	8.0+0.3 -0.3	4.0	1.75
	F	D	D1	Po	P1	Ao	Bo	Ko	t
	3.5±0.05	1.5+0.1	φ 0.1MIN	4.0	2.0±0.05	3.1	3.0	1.3	0.2±0.03
Application	A	B	C	J	T1	T2	W	P	E
SOT-23-5	178±1	72±1.0	13.0+0.2	2.5±0.15	8.4±2	1.5±0.3	8.0±0.3	4±0.1	1.75±0.1
	F	D	D1	Po	P1	Ao	Bo	Ko	t
	3.5±0.05	1.5±0.1	1.5±0.1	4.0±0.1	2.0±0.1	3.15±0.1	3.2±0.1	1.4±0.1	0.2±0.033

Carrier Tape & Reel Dimensions

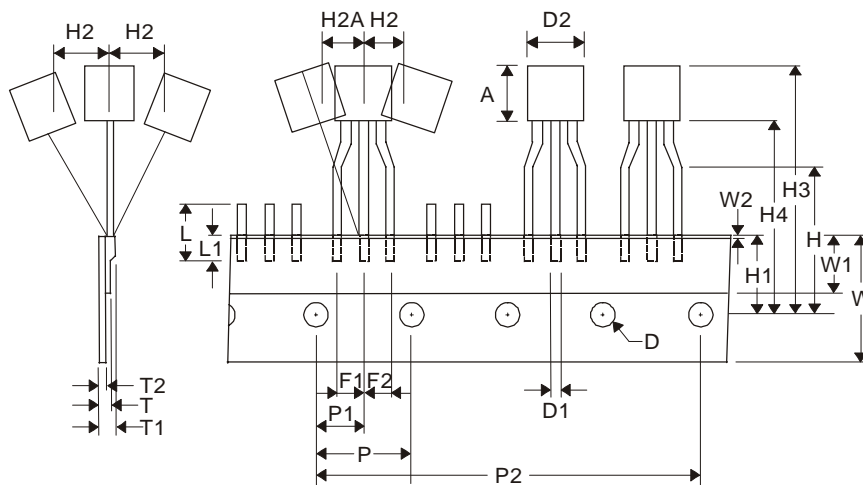

Application	A	D	D1	D2	F1,F2	H	H1	H2	H2A
TO-92	3.18~12	4.0±0.2	0.36~0.53	9.0 MAX	2.5+0.2 -0.1	16±0.5	9±0.5	0.5 MAX	0.5 MAX
	H3	H4	L	L1	P	P1	P2	T	T1
	27.0 MAX	20.0 MAX	11.0 MAX	2.5 MIN	12.7±0.2	6.35±0.4	50.8±0.5	0.55 MAX	1.42 MAX
	T2	W	W1	W2					
	0.36~0.68	17.5~19	5.0~7.0	0.5 MAX					

(mm)

Cover Tape Dimensions

Application	Carrier Width	Cover Tape Width	Devices Per Reel
SOT- 23	8	5.3	3000
SOT-23-5	8	5.3	3000
SOT- 89	12	9.3	1000
TO-92	17.5~19	5.0~7.0	2000

Customer Service

Anpec Electronics Corp.

Head Office :

5F, No. 2 Li-Hsin Road, SBIP,

Hsin-Chu, Taiwan, R.O.C.

Tel : 886-3-5642000

Fax : 886-3-5642050

Taipei Branch :

7F, No. 137, Lane 235, Pac Chiao Rd.,

Hsin Tien City, Taipei Hsien, Taiwan, R. O. C.

Tel : 886-2-89191368

Fax : 886-2-89191369