

ABSOLUTE MAXIMUM RATINGS (Note 1)

Power Dissipation Internally Limited
 Input to Output Voltage Differential 40V
 Storage Temperature Range -65°C to 150°C

Operating Junction Temperature
 Hermetic (K, R, T, L, IG-Packages) 150°C
 Lead Temperature (Soldering, 10 Seconds) 300°C

Note 1. Exceeding these ratings could cause damage to the device.

THERMAL DATA

K Package:

Thermal Resistance-Junction to Case, θ_{JC} 3.0°C/W
 Thermal Resistance-Junction to Ambient, θ_{JA} 35°C/W

R Package:

Thermal Resistance-Junction to Case, θ_{JC} 5.0°C/W
 Thermal Resistance-Junction to Ambient, θ_{JA} 40°C/W

T Package:

Thermal Resistance-Junction to Case, θ_{JC} 15°C/W
 Thermal Resistance-Junction to Ambient, θ_{JA} 120°C/W

IG Package:

Thermal Resistance-Junction to Case, θ_{JC} 3.5°C/W
 Thermal Resistance-Junction to Ambient, θ_{JA} 42°C/W

L Package:

Thermal Resistance-Junction to Case, θ_{JC} 35°C/W
 Thermal Resistance-Junction to Ambient, θ_{JA} 120°C/W

Note A. Junction Temperature Calculation: $T_J = T_A + (P_D \times \theta_{JA})$.

Note B. The above numbers for θ_{JC} are maximums for the limiting thermal resistance of the package in a standard mounting configuration. The θ_{JA} numbers are meant to be guidelines for the thermal performance of the device/pc-board system. All of the above assume no ambient airflow.

RECOMMENDED OPERATING CONDITIONS (Note 2 & 3)

Input Voltage Range ($V_{OUT} + 3.5V$) to 37V

Operating Junction Temperature Range

SG117A/SG117 -55°C to 150°C
 SG217A/SG217 -25°C to 150°C
 SG317A/SG317 0°C to 125°C

Note 2. Range over which the device is functional.

Note 3. These ratings are applicable for junction temperatures of less than 150°C.

ELECTRICAL CHARACTERISTICS

(Unless otherwise specified, these specifications apply over full operating ambient temperatures for SG117A/SG117 with $-55^\circ\text{C} \leq T_A \leq 125^\circ\text{C}$, SG217A/SG217 with $-25^\circ\text{C} \leq T_A \leq 150^\circ\text{C}$, SG 317A/SG317 with $0^\circ\text{C} \leq T_A \leq 125^\circ\text{C}$, $V_{IN} - V_{OUT} = 5.0V$, and for $I_{OUT} = 500\text{mA}$ (K, R, and IG), and $I_{OUT} = 100\text{mA}$ (T and L packages). Although power dissipation is internally limited, these specifications are applicable for power dissipations of 2W for the T and L packages, and 20W for the K, R, and IG packages. I_{MAX} is 1.5A for the K, R, and IG packages and 500mA for the T and L packages. Low duty cycle pulse testing techniques are used which maintains junction and case temperatures equal to the ambient temperature.)

Parameter	Test Conditions	SG117A/SG217A			SG117/SG217			Units
		Min.	Typ.	Max.	Min.	Typ.	Max.	
Reference Voltage	$I_{OUT} = 10\text{mA}$, $T_A = 25^\circ\text{C}$ $3V \leq (V_{IN} - V_{OUT}) \leq 40V$, $P \leq P_{MAX}$	1.238	1.250	1.262				V
Line Regulation (Note 4)	$10\text{mA} \leq I_{OUT} \leq I_{MAX}$ $3V \leq (V_{IN} - V_{OUT}) \leq 40V$, $I_L = 10\text{mA}$ $T_A = 25^\circ\text{C}$	1.225	1.250	1.270	1.20	1.25	1.30	V
	$T_A = T_{MIN}$ to T_{MAX}		0.005	0.01		0.01	0.02	%/V
Load Regulation (Note 4)	$10\text{mA} \leq I_{OUT} \leq I_{MAX}$ $V_{OUT} \leq 5V$, $T_A = 25^\circ\text{C}$					0.01	0.02	%/V
	$V_{OUT} \geq 5V$, $T_A = 25^\circ\text{C}$		0.1	0.3		0.1	0.3	%
Thermal Regulation (Note 5)	$V_{OUT} \leq 5V$		20	50		20	50	mV
	$V_{OUT} \geq 5V$		0.3	1		0.3	1	%
	$T_A = 25^\circ\text{C}$, 20ms pulse		0.002	0.02		0.03	0.07	%/W
	Ripple Rejection	$V_{OUT} = 10V$, $f = 120\text{Hz}$ $C_{ADJ} = 1\mu\text{F}$, $T_A = 25^\circ\text{C}$ $C_{ADJ} = 10\mu\text{F}$	66	80		66	80	
Adjust Pin Current			50	100		50	100	μA
Adjust Pin Current Change	$10\text{mA} \leq I_{OUT} \leq I_{MAX}$, $2.5V \leq (V_{IN} - V_{OUT}) \leq 40V$		0.2	5		0.2	5	μA

ELECTRICAL CHARACTERISTICS (continued)

Parameter	Test Conditions	SG117A/SG217A			SG117/SG217			Units
		Min.	Typ.	Max.	Min.	Typ.	Max.	
Minimum Load Current	$(V_{IN} - V_{OUT}) = 40V$		3.5	5		3.5	5	mA
Current Limit	$(V_{IN} - V_{OUT}) \leq 15V$							
	K, P, R, IG Packages	1.5	2.2		1.5	2.2		A
	T, L Packages	0.5	0.8		0.5	0.8		A
	$(V_{IN} - V_{OUT}) = 40V, T_J = 25^\circ C$							
	K, P, R, IG Packages	0.3	0.4		0.3	0.4		A
	T, L Packages	0.15	0.2		0.15	0.2		A
Temperature Stability (Note 5)			1	2		1		%
Long Term Stability (Note 5)	$T_A = 125^\circ C, 1000 \text{ Hours}$		0.3	1		0.3	1	%
RMS Output Noise (% of V_{OUT})	$T_A = 25^\circ C, 10Hz \leq f \leq 10 \text{ KHz}$ (Note 5)		0.001			0.001		%

Parameter	Test Conditions	SG317A			SG317			Units
		Min.	Typ.	Max.	Min.	Typ.	Max.	
Reference Voltage	$I_{OUT} = 10mA, T_A = 25^\circ C$	1.238	1.250	1.262				V
	$3V \leq (V_{IN} - V_{OUT}) \leq 40V, P \leq P_{MAX}$							
	$10mA \leq I_{OUT} \leq I_{MAX}$	1.225	1.250	1.270	1.20	1.25	1.30	V
Line Regulation (Note 4)	$3V \leq (V_{IN} - V_{OUT}) \leq 40V, I_L = 10mA$							
	$T_A = 25^\circ C$		0.005	0.01		0.01	0.04	%/V
	$T_A = T_{MIN}$ to T_{MAX}		0.01	0.02		0.02	0.07	%/V
Load Regulation (Note 4)	$10mA \leq I_{OUT} \leq I_{MAX}$							
	$V_{OUT} \leq 5V, T_A = 25^\circ C$		5	25		5	25	mV
	$V_{OUT} \geq 5V, T_A = 25^\circ C$		0.1	0.5		0.1	0.5	%
	$V_{OUT} \leq 5V$		20	50		20	70	mV
	$V_{OUT} \geq 5V$		0.3	1		0.3	1.5	%
Thermal Regulation (Note 5)	$T_A = 25^\circ C, 20ms \text{ pulse}$		0.002	0.02		0.03	0.07	%/W
Ripple Rejection	$V_{OUT} = 10V, f = 120Hz$							
	$C_{ADJ} = 1\mu F, T_A = 25^\circ C$		65			65		dB
	$C_{ADJ} = 10\mu F$	66	80		66	80		dB
Adjust Pin Current	$T_A = 25^\circ C$		50	100		50	100	μA
Adjust Pin Current Change	$10mA \leq I_{OUT} \leq I_{MAX}, 2.5V \leq (V_{IN} - V_{OUT}) \leq 40V$		0.2	5		0.2	5	μA
Minimum Load Current	$(V_{IN} - V_{OUT}) = 40V$		3.5	10		3.5	10	mA
Current Limit	$(V_{IN} - V_{OUT}) \leq 15V$							
	K, P, R, IG Packages	1.5	2.2		1.5	2.2		A
	T, L Packages	0.5	0.8		0.5	0.8		A
	$(V_{IN} - V_{OUT}) = 40V, T_J = 25^\circ C$							
	K, P, R, IG Packages	0.15	0.4		0.15	0.4		A
	T, L Packages	.075	0.2		.075	0.2		A
Temperature Stability (Note 5)			1	2		1		%
Long Term Stability (Note 5)	$T_A = 125^\circ C$		0.3	1		0.3	1	%
RMS Output Noise (% of V_{OUT})	$T_A = 25^\circ C, 10Hz \leq f \leq 10KHz$ (Note 5)		0.001			0.001		%

Note 4. Regulation is measured at constant junction temperature, using pulse testing with a low duty cycle. Changes in output voltage due to heating effects are covered under the specification for thermal regulation.

Note 5. These parameters, although guaranteed, are not tested in production.

CHARACTERISTIC CURVES

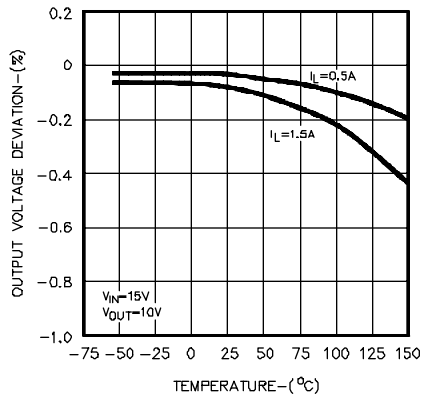

FIGURE 1.
OUTPUT VOLTAGE DEVIATION VS. TEMPERATURE

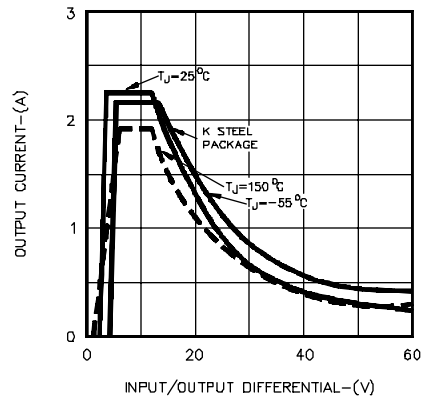

FIGURE 2.
OUTPUT CURRENT VS. INPUT/OUTPUT DIFFERENTIAL

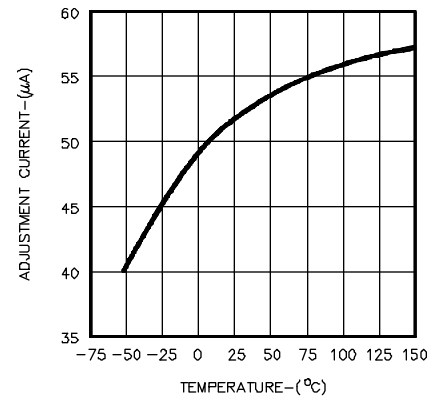

FIGURE 3.
ADJUSTMENT CURRENT VS. TEMPERATURE

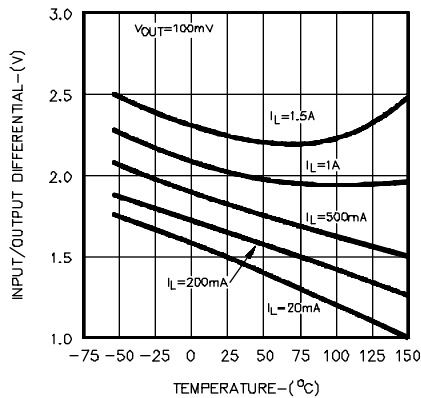

FIGURE 4.
INPUT/OUTPUT DIFFERENTIAL VS. TEMPERATURE

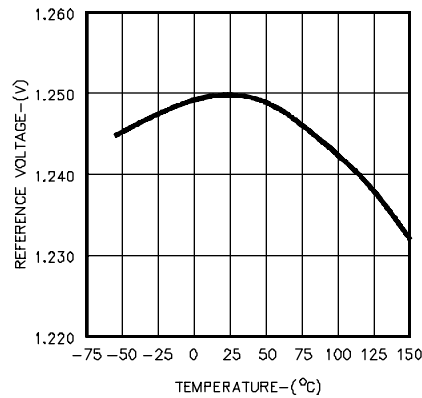

FIGURE 5.
REFERENCE VOLTAGE VS. TEMPERATURE

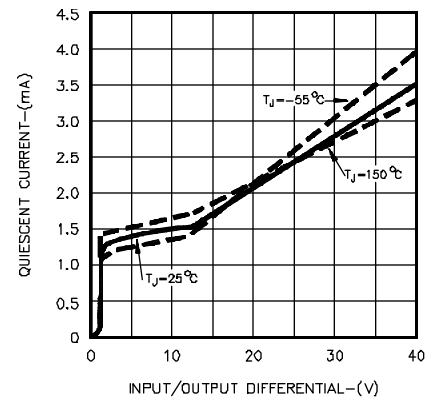

FIGURE 6.
QUIESCENT CURRENT VS. INPUT/OUTPUT DIFFERENTIAL

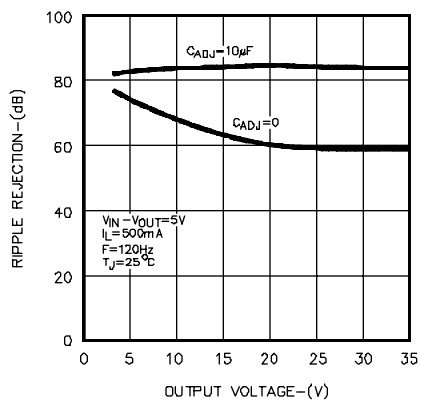

FIGURE 7.
RIPPLE REJECTION VS. OUTPUT VOLTAGE

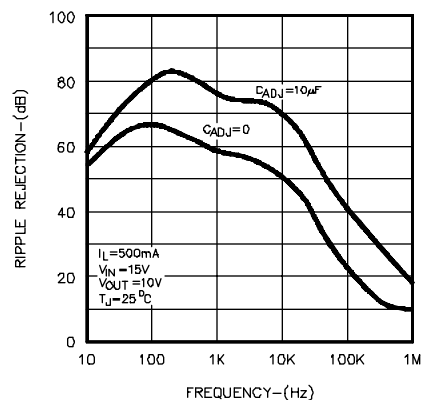

FIGURE 8.
RIPPLE REJECTION VS. FREQUENCY

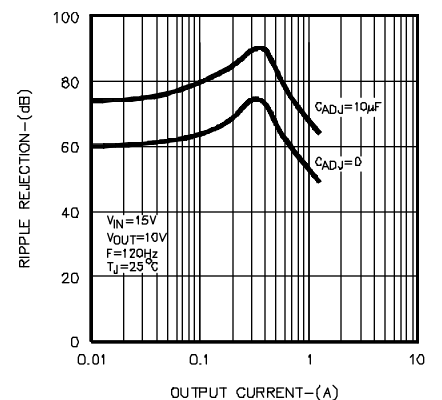

FIGURE 9.
RIPPLE REJECTION VS. OUTPUT CURRENT

CHARACTERISTIC CURVES (continued)

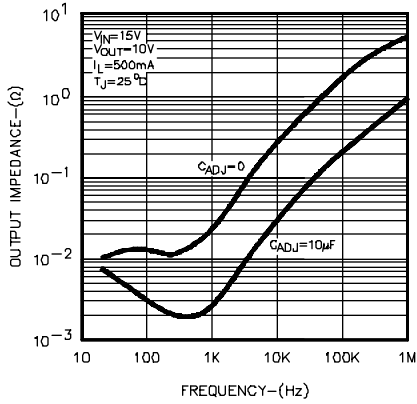

FIGURE 10.
OUTPUT IMPEDANCE VS. FREQUENCY

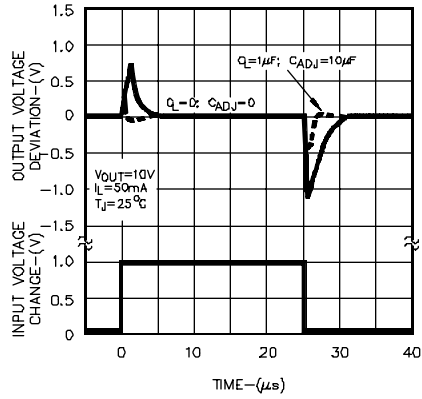

FIGURE 11.
LINE TRANSIENT RESPONSE

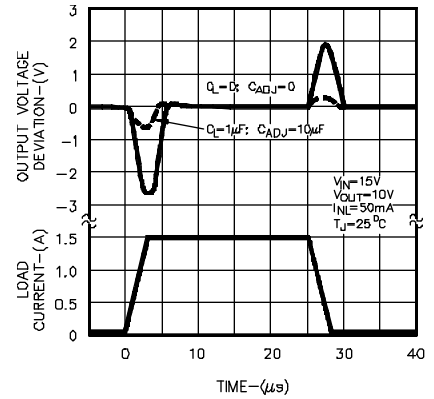

FIGURE 12.
LOAD TRANSIENT RESPONSE

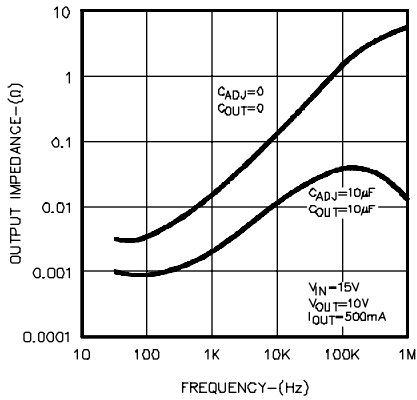

FIGURE 13.
OUTPUT IMPEDANCE VS. FREQUENCY

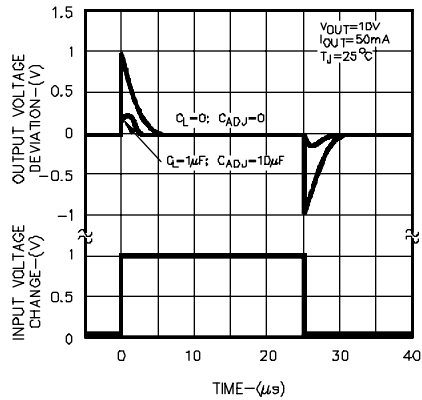

FIGURE 14.
LINE TRANSIENT RESPONSE

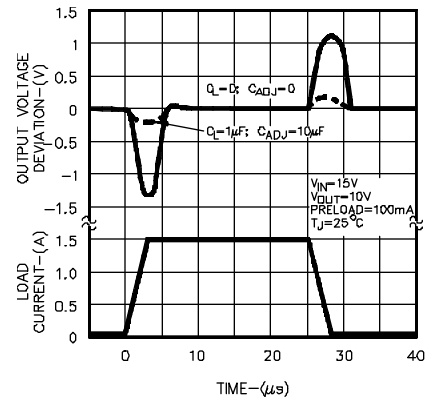

FIGURE 15.
LOAD TRANSIENT RESPONSE

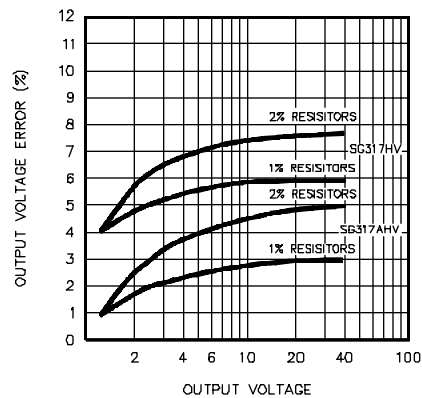
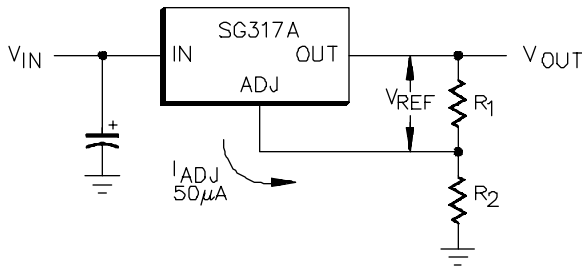

FIGURE 16.
OUTPUT VOLTAGE ERROR

APPLICATION INFORMATION

GENERAL

The SG117A develops a 1.25V reference voltage between the output and the adjustable terminal (see Figure 1). By placing a resistor, R_1 between these two terminals, a constant current is caused to flow through R_1 and down through R_2 to set the overall output voltage. Normally this current is the specified minimum load current of 5mA or 10mA.



$$V_{OUT} = V_{REF} \left(1 + \frac{R_2}{R_1} \right) + I_{ADJ} R_2$$

FIGURE 17 - BASIC REGULATOR CIRCUIT

Because I_{ADJ} is very small and constant when compared with the current through R_1 , it represents a small error and can usually be ignored.

It is easily seen from the above equation, that even if the resistors were of exact value, the accuracy of the output is limited by the accuracy of V_{REF} . Earlier adjustable regulators had a reference tolerance of $\pm 4\%$. This tolerance is dangerously close to the $\pm 5\%$ supply tolerance required in many logic and analog systems. Further, many 1% resistors can drift $0.01\%^\circ\text{C}$ adding another 1% to the output voltage tolerance.

For example, using 2% resistors and $\pm 4\%$ tolerance for V_{REF} , calculations will show that the expected range of a 5V regulator design would be $4.66\text{V} \leq V_{OUT} \leq 5.36\text{V}$ or approximately $\pm 7\%$. If the same example were used for a 15V regulator, the expected tolerance would be $\pm 8\%$. With these results most applications require some method of trimming, usually a trim pot. This solution is expensive and not conducive to volume production.

One of the enhancements of Silicon General's adjustable regulators over existing devices is tightened initial tolerance. This allows relatively inexpensive 1% or 2% film resistors to be used for R_1 and R_2 while setting output voltage within an acceptable tolerance range.

With a guaranteed 1% reference, a 5V power supply design, using $\pm 2\%$ resistors, would have a worst case manufacturing tolerance of $\pm 4\%$. If 1% resistors were used, the tolerance would drop to $\pm 2.5\%$. A plot of the worst case output voltage tolerance as a function of resistor tolerance is shown on the front page.

For convenience, a table of standard 1% resistor values is shown below.

Table of 1/2% and 1% Standard Resistance Values

1.00	1.47	2.15	3.16	4.64	6.81
1.02	1.50	2.21	3.24	4.75	6.98
1.05	1.54	2.26	3.32	4.87	7.15
1.07	1.58	2.32	3.40	4.99	7.32
1.10	1.62	2.37	3.48	5.11	7.50
1.13	1.65	2.43	3.57	5.23	7.68
1.15	1.69	2.49	3.65	5.36	7.87
1.18	1.74	2.55	3.74	5.49	8.06
1.21	1.78	2.61	3.83	5.62	8.25
1.24	1.82	2.67	3.92	5.76	8.45
1.27	1.87	2.74	4.02	5.90	8.66
1.30	1.91	2.80	4.12	6.04	8.87
1.33	1.96	2.87	4.22	6.19	9.09
1.37	2.00	2.94	4.32	6.34	9.31
1.40	2.05	3.01	4.42	6.49	9.53
1.43	2.10	3.09	4.53	6.65	9.76

Standard Resistance Values are obtained from the Decade Table by multiplying by multiples of 10. As an example: 1.21 can represent 1.21 Ω , 12.1 Ω , 121 Ω , 1.21K Ω etc.

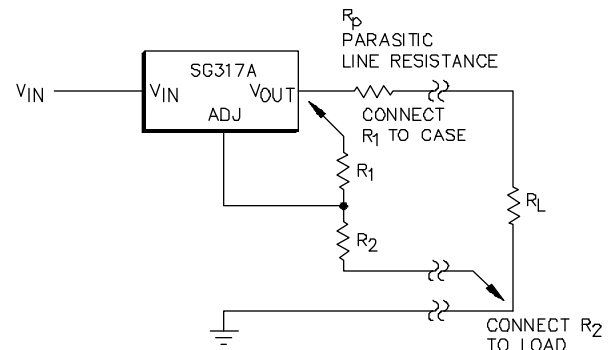
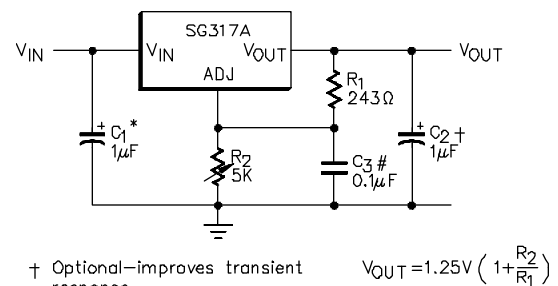

FIGURE 18 - CONNECTIONS FOR BEST LOAD REGULATION



† Optional—improves transient response

* Needed if device is far from filter capacitors

Needed if load current is mechanically switched

FIGURE 19 - 1.2V-25V ADJUSTABLE REGULATOR

APPLICATION INFORMATION (continued)

BYPASS CAPACITORS

Input bypassing using a 1µF tantalum or 25µF electrolytic is recommended when the input filter capacitors are more than 5 inches from the device. A 0.1µF bypass capacitor on the ADJUST pin is required if the load current varies by more than 1A/µsec. Improved ripple rejection (80dB) can be accomplished by adding a 10µF capacitor from the adjust pin to ground. For improved AC transient response and to prevent the possibility of oscillation due to unknown reactive load, a 1µF capacitor is also recommended at the output. Because of their low impedance at high frequencies, the best type of capacitor to use is solid tantalum.

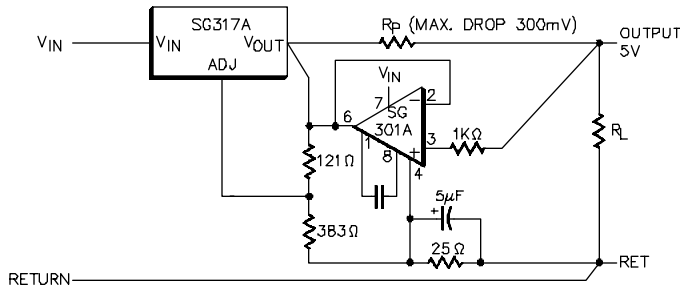
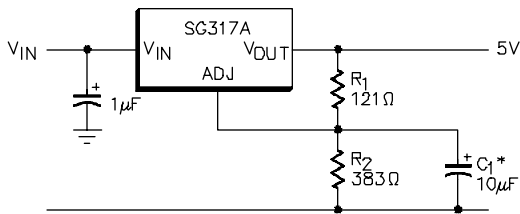

FIGURE 20 - REMOTE SENSING



* C₁ Improves Ripple Rejection. X_C should be small compared to R₂.

FIGURE 21 - IMPROVING RIPPLE REJECTION

LOAD REGULATION

Because the SG117A is a three-terminal device, it is not possible to provide true remote load sensing. Load regulation will be limited by the resistance of the wire connecting the regulator to the load. For the data sheet specification, regulation is measured at the bottom of the package. Negative side sensing is a true Kelvin connection, with the bottom of the output divider returned to the negative side of the load. Although it may not be immediately obvious, best load regulation is obtained when the top of the divider is connected directly to the case, not to the load. This is illustrated in Figure 18. If R₁ were connected to the load, the effective resistance between the regulator and the load would be

$$R_p \times \left(\frac{R_2 + R_1}{R_1} \right), R_p = \text{Parasitic Line Resistance.}$$

Connected as shown, R_p is not multiplied by the divider ratio. R_p is about 0.004Ω per foot using 16 gauge wire. This translates to 4mV/ft. at 1A load current, so it is important to keep the positive lead between regulator and load as short as possible.

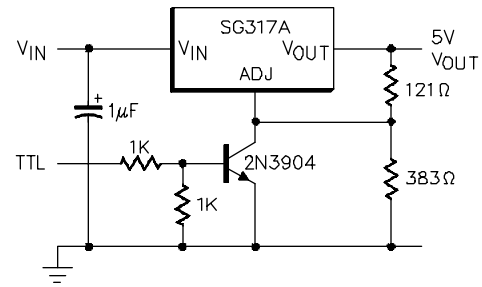

FIGURE 22 - 5V REGULATOR WITH SHUT DOWN

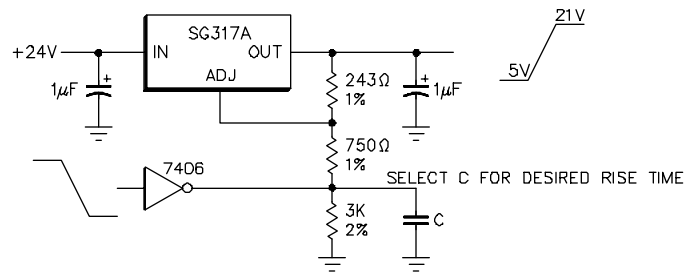

FIGURE 23 - 21V PROGRAMMING SUPPLY FOR UV PROM/EEPROM

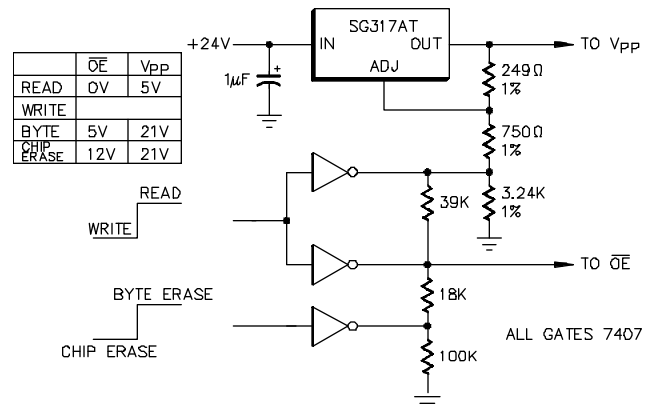

FIGURE 24 - 2816 EEPROM SUPPLY PROGRAMMER FOR READ/WRITE CONTROL

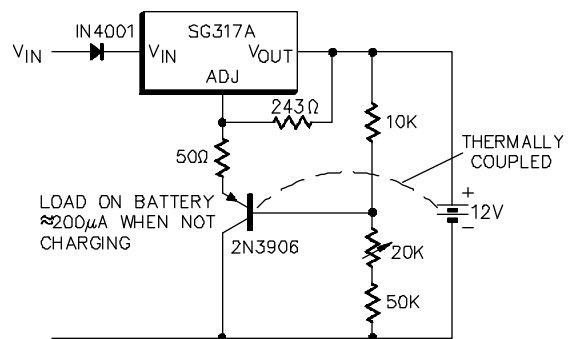

FIGURE 25 - TEMPERATURE COMPENSATED LEAD ACID BATTERY CHARGER

CONNECTION DIAGRAMS & ORDERING INFORMATION (See Notes Below)

Package	Part No.	Ambient Temperature Range	Connection Diagram
3-TERMINAL TO-3 METAL CAN K-PACKAGE	SG117AK/883B	-55°C to 125°C	
	SG117AK/DESC	-55°C to 125°C	
	SG117AK	-55°C to 125°C	
	SG217AK	-25°C to 85°C	
	SG317AK	0°C to 70°C	
	SG117K/883B	-55°C to 125°C	
	JAN117K	-55°C to 125°C	
	SG117K/DESC	-55°C to 125°C	
	SG117K	-55°C to 125°C	
	SG217K	-25°C to 85°C	
SG317K	0°C to 70°C		
3-TERMINAL TO-66 METAL CAN R-PACKAGE	SG117AR/883B	-55°C to 125°C	
	SG117AR/DESC	-55°C to 125°C	
	SG117AR	-55°C to 125°C	
	SG217AR	-25°C to 85°C	
	SG317AR	0°C to 70°C	
	SG117R/883B	-55°C to 125°C	
	SG117AR/DESC	-55°C to 125°C	
	SG117R	-55°C to 125°C	
	SG217R	-25°C to 85°C	
	SG317R	0°C to 70°C	
3-PIN TO-39 METAL CAN T-PACKAGE	SG117AT/883B	-55°C to 125°C	
	SG117AT/DESC	-55°C to 125°C	
	SG117AT	-55°C to 125°C	
	SG217AT	-25°C to 85°C	
	SG317AT	0°C to 70°C	
	SG117T/883B	-55°C to 125°C	
	JAN117T	-55°C to 125°C	
	SG117T/DESC	-55°C to 125°C	
	SG117T	-55°C to 125°C	
	SG217T	-25°C to 85°C	
SG317T	0°C to 70°C		
3-PIN HERMETIC TO-257 IG-PACKAGE (Isolated)	SG117AIG/883B	-55°C to 125°C	
	SG117AIG/DESC	-55°C to 125°C	
	SG117AIG	-55°C to 125°C	
	SG117IG/883B	-55°C to 125°C	
	SG117IG/DESC	-55°C to 125°C	
	SG117IG	-55°C to 125°C	
20-PIN CERAMIC (LCC) LEADLESS CHIP CARRIER L- PACKAGE	SG117AL/883B	-55°C to 125°C	<p>(Note 4)</p>
	SG117AL/DESC	-55°C to 125°C	
	SG117AL	-55°C to 125°C	
	SG117L/883B	-55°C to 125°C	
	SG117L/DESC	-55°C to 125°C	
	SG117L	-55°C to 125°C	

- Note 1. Contact factory for JAN and DESC product availability.
 2. All parts are viewed from the top.
 3. Both inputs and outputs must be externally connected together at the device terminals.
 4. For normal operation the SENSE pin must be externally connected to the load.