



DUAL OPERATIONAL TRANSCONDUCTANCE AMPLIFIER

GENERAL DESCRIPTION

The NJM13600/13700 consist of two current controlled transconductance amplifiers each with differential inputs and a push pull output. The two amplifiers share common supplies but otherwise operate independently. Linearizing diodes are provided at the inputs to reduce distortion and allow higher input levels. The results is a 10 dB signal-to-noise improvement referenced to 0.5 percent THD. Controlled impedance buffers are provided which are especially designed to complement the dynamic range of the amplifiers.

PACKAGE OUTLINE

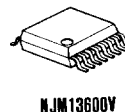
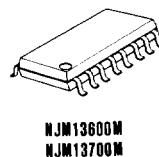
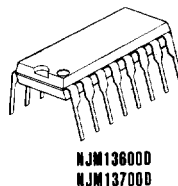

FEATURES

- Package Outline
- Bipolar Technology

DIP16, DMP16, (SSOP16)

PIN CONFIGURATION

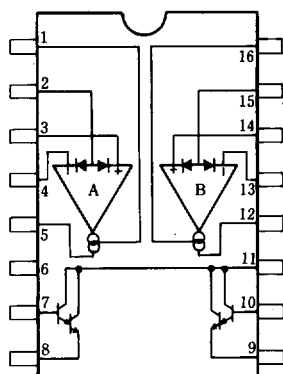

NJM13600D, NJM13600M, NJM13600V
NJM13700D, NJM13700M.

PIN FUNCTION

- | | |
|---------------------|----------------------|
| 1. Amp Bias Input A | 9. Buffer Output B |
| 2. Diode Bias A | 10. Buffer Input B |
| 3. + Input | 11. V ⁺ |
| 4. - Input | 12. Output B |
| 5. Output A | 13. - Input B |
| 6. V ⁻ | 14. + Input B |
| 7. Buffer Input A | 15. Diode Bias B |
| 8. Buffer Output A | 16. Amp Bias Input B |

EQUIVALENT CIRCUIT

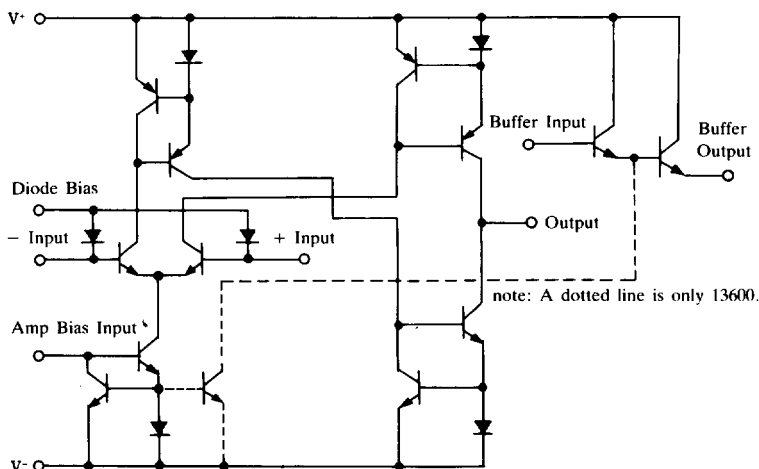

4



■ ABSOLUTE MAXIMUM RATINGS

(Ta=25°C)

PARAMETER	SYMBOL	RATINGS	UNIT
Supply Voltage	V ⁺ /V ⁻	36 or ±18	V
Differential Input Voltage	V _{ID}	±5	V
Diode Bias Current	I _D	2	mA
Amp Bias Current	I _{ABC}	2	mA
Buffer Output Current	I _O	20	mA
Power Dissipation	P _D	(DIP16) 570	mW
		(DMP16) 700	mW
DC Input Voltage	V _{IN}	V ⁺ ~V ⁻	
Operating Temperature Range	T _{opr}	-20~+75	°C
Storage Temperature Range	T _{stg}	-40~+125	°C

(note) At on a ceramic PCB (10×20×0.635mm)

■ ELECTRICAL CHARACTERISTICS

(V⁺/V⁻=±15V, Ta=25°C, I_{ABC}=500μA)

PARAMETER	SYMBOL	TEST CONDITION	13600			13700			UNIT
			MIN.	TYP.	MAX.	MIN.	TYP.	MAX.	
Input Offset Voltage (V _{OS})	V _{IO}		—	0.4	5	—	0.4	4	mV
Input Offset Voltage		I _{ABC} =5μA	—	0.3	5	—	0.3	4	mV
V _{OS} Including Diodes		Diode Bias Current, I _D =500μA	—	0.5	5	—	0.5	5	mV
Input Offset Change		5μA ≤ I _{ABC} ≤ 500μA	—	0.1	—	—	0.1	3	mV
Input Bias Current	I _B		—	0.4	5	—	0.4	5	μA
Input Bias Current		(-20~+75°C)	—	1	8	—	1	8	μA
Forward Transconductance(gm)	gm		6,700	9,600	13,000	6,700	9,600	13,000	μΩ
		(-20~+75°C)	5,400	—	—	5,400	—	—	μΩ
gm Tracking		R _L =0, I _{ABC} =5μA	—	0.3	—	—	0.3	—	dB
Peak Output Current	I _{OP}	R _L =0, I _{ABC} =5μA	—	5	—	—	0	—	μA
Peak Output Current		R _L =0, I _{ABC} =500μA	350	500	650	350	500	650	μA
Peak Output Current		R _L =0, -20~+75°C	300	—	—	300	—	—	μA
Peak Output Voltage Positive	V _{OP}	R _L =∞, 5μA ≤ I _{ABC} ≤ 500μA	+12	+14.2	—	+12	+14.2	—	V
Peak Output Voltage Negative		R _L =∞, 5μA ≤ I _{ABC} ≤ 500μA	-12	-14.4	—	-12	-14.4	—	V
Operating Current	I _{CC}	I _{ABC} =500μA, two circuit	—	2.6	—	—	2.6	—	mA
V _{OS} Sensitivity Positive	SVR	ΔV _{OS} /ΔV ⁺	76.5	94	—	76.5	94	—	dB
V _{OS} Sensitivity Negative		ΔV _{OS} /ΔV ⁻	76.5	94	—	76.5	94	—	dB
Input Offset Current	I _{IO}		—	0.1	0.6	—	0.1	0.6	μA
CMRR	CMR		80	110	—	80	110	—	dB
Common Mode Range	V _{ICM}		±12	±13.5	—	±12	±13.5	—	V
Cross talk	CT	20Hz<f<20kHz (note 2)	—	-100	—	—	-100	—	dB
Differential Input Current	I _{ID}	I _{ABC} =0, Input=±4V	—	0.02	100	—	0.02	100	nA
Leakage Current	I _{LEAK}	I _{ABC} =0 (Refer to Test Circuit)	—	0.2	100	—	0.2	100	nA
Input Resistance	R _{IN}		10	26	—	10	26	—	kΩ
Open Loop Bandwidth			—	2	—	—	2	—	MHz
Slew Rate	SR		—	50	—	—	50	—	V/μS
Buffer Input Current		(note 2)	—	0.4	5	—	0.4	5	μA
Peak Buffer Output Voltage		(note 2)	10	—	—	10	—	—	V

(note 1) Open unless otherwise specified. The inputs to the buffers are grounded and outputs are open.

(note 2) R_{OUT}=5kΩ connected from the buffer output to V⁻ and the input of buffer is connected to the transconductance amplifier output.
I_{ABC}=500μA

4



■ TEST CIRCUIT

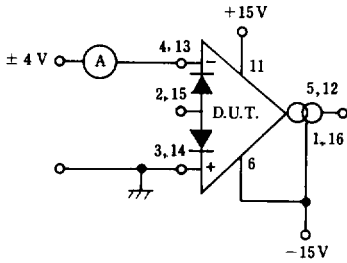

Differential Input Current

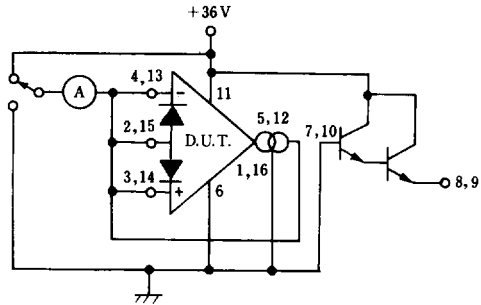

Leakage Current

■ TYPICAL APPLICATIONS

Unity Gain-Follower

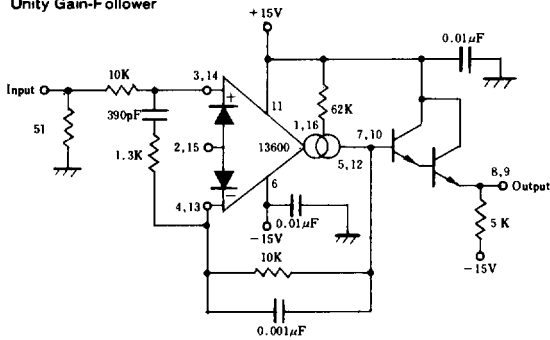

4



■ TYPICAL CHARACTERISTICS

Distortion vs. Differential Input Voltage

($V^+/V^- = \pm 15V$, $R_L = 10k\Omega$, $I_{ABC} = 1mA$, $T_a = 25^\circ C$)

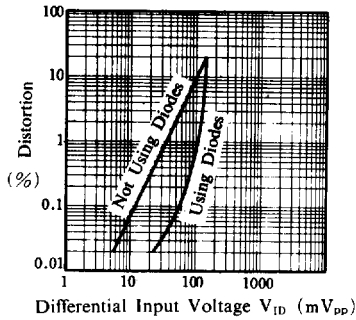

Voltage vs. Amplifier Bias Current

($V^+/V^- = \pm 15V$, $R_L = 10k\Omega$, $T_a = 25^\circ C$)

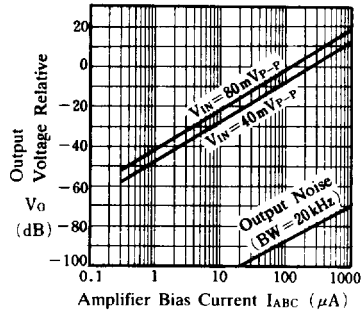

Output Noise Current vs. Frequency

($T_a = 25^\circ C$)

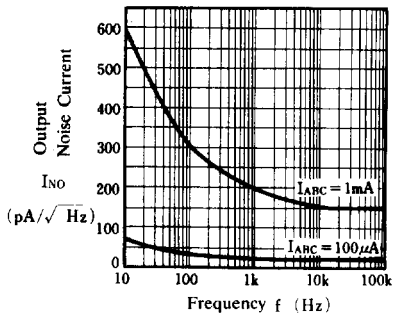

4



■ TYPICAL CHARACTERISTICS

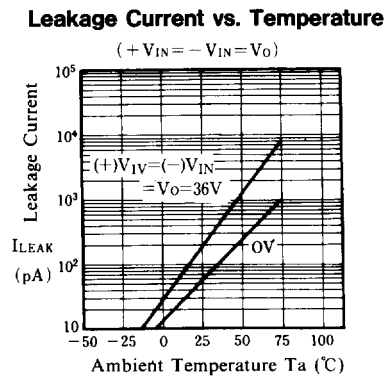
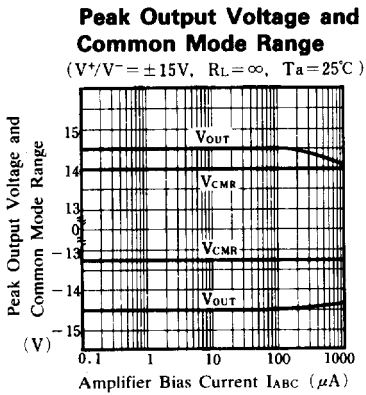
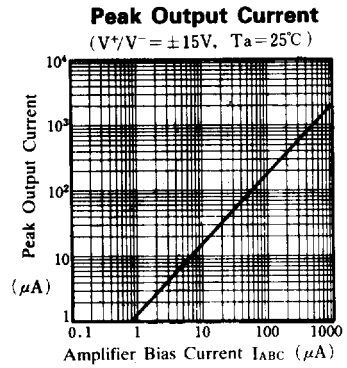
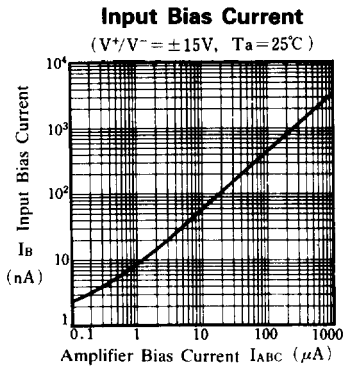
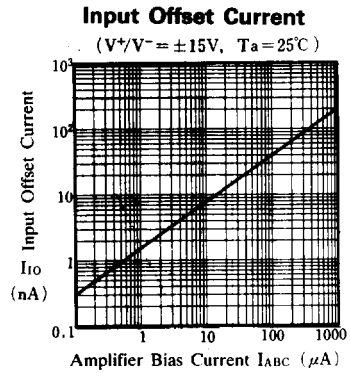
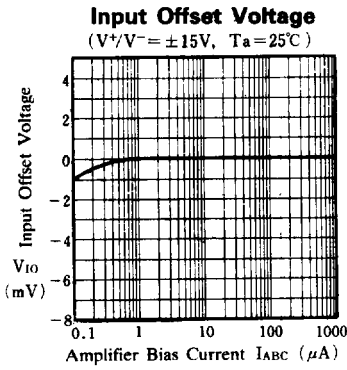



■ TYPICAL CHARACTERISTICS

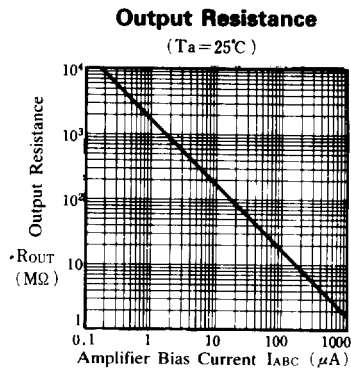
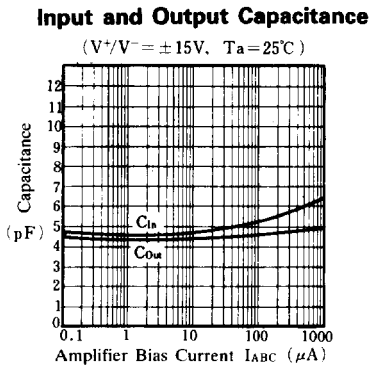
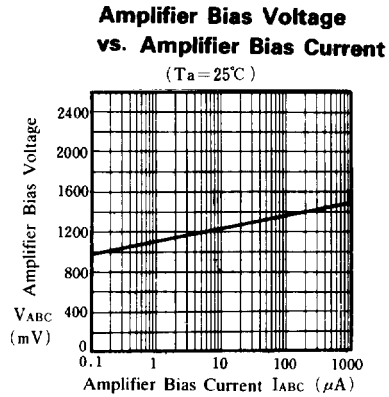
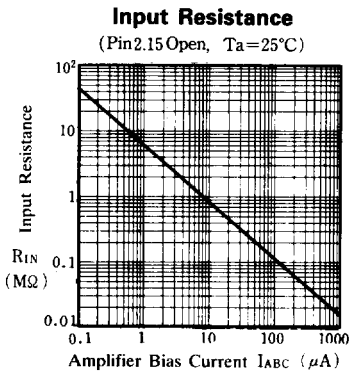
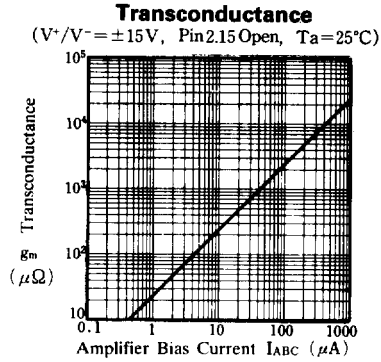
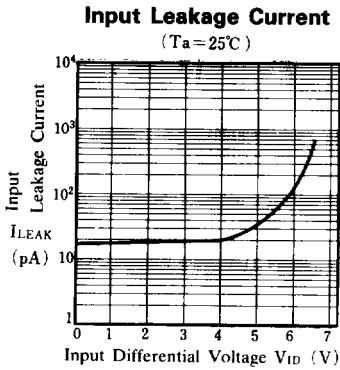

4