

SMPS MOSFET

IRLR8203
IRLU8203

HEXFET® Power MOSFET

Applications

- High Frequency Isolated DC-DC Converters with Synchronous Rectification for Telecom and Industrial Use
- High Frequency Buck Converters for Computer Processor Power

V_{DSS}	R_{DS(on)} max	I_D
30V	6.8mΩ	110A^④

Benefits

- Ultra-Low Gate Impedance
- Very Low RDS(on) at 4.5V V_{GS}
- Fully Characterized Avalanche Voltage and Current

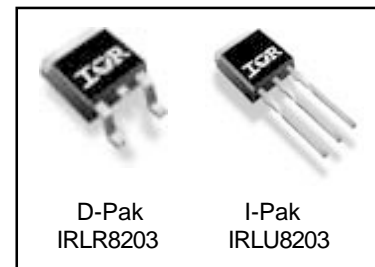

Absolute Maximum Ratings

Symbol	Parameter	Max.	Units
V _{DS}	Drain-Source Voltage	30	V
V _{GS}	Gate-to-Source Voltage	± 20	V
I _D @ T _C = 25°C	Continuous Drain Current, V _{GS} @ 10V	110 ^④	A
I _D @ T _C = 100°C	Continuous Drain Current, V _{GS} @ 10V	76 ^④	
I _{DM}	Pulsed Drain Current ^①	120	
P _D @ T _C = 25°C	Maximum Power Dissipation ^③	140	W
P _D @ T _C = 100°C	Maximum Power Dissipation ^③	69	W
	Linear Derating Factor	0.92	W/°C
T _J , T _{STG}	Junction and Storage Temperature Range	-55 to + 175	°C

Thermal Resistance

	Parameter	Typ.	Max.	Units
R _{θJC}	Junction-to-Case	—	1.09	°C/W
R _{θJA}	Junction-to-Ambient (PCB mount)*	—	50	
R _{θJA}	Junction-to-Ambient	—	110	

* When mounted on 1" square PCB (FR-4 or G-10 Material) .
For recommended footprint and soldering techniques refer to application note #AN-994

Notes ① through ④ are on page 10

Static @ T_J = 25°C (unless otherwise specified)

	Parameter	Min.	Typ.	Max.	Units	Conditions
V _{(BR)DSS}	Drain-to-Source Breakdown Voltage	30	—	—	V	V _{GS} = 0V, I _D = 250μA
ΔV _{(BR)DSS} /ΔT _J	Breakdown Voltage Temp. Coefficient	—	0.027	—	V/°C	Reference to 25°C, I _D = 1mA
R _{DS(on)}	Static Drain-to-Source On-Resistance	—	5.6	6.8	mΩ	V _{GS} = 10V, I _D = 15A ③
		—	7.1	9.0		V _{GS} = 4.5V, I _D = 12A ③
V _{GS(th)}	Gate Threshold Voltage	1.0	—	3.0	V	V _{DS} = V _{GS} , I _D = 250μA
I _{DSS}	Drain-to-Source Leakage Current	—	—	20	μA	V _{DS} = 24V, V _{GS} = 0V
		—	—	100		V _{DS} = 24V, V _{GS} = 0V, T _J = 125°C
I _{GSS}	Gate-to-Source Forward Leakage	—	—	200	nA	V _{GS} = 20V
	Gate-to-Source Reverse Leakage	—	—	-200		V _{GS} = -20V

Dynamic @ T_J = 25°C (unless otherwise specified)

Symbol	Parameter	Min.	Typ.	Max.	Units	Conditions
g _{fs}	Forward Transconductance	35	—	—	S	V _{DS} = 15V, I _D = 12A
Q _g	Total Gate Charge	—	33	50	nC	I _D = 12A
Q _{gs}	Gate-to-Source Charge	—	5.7	8.5		V _{DS} = 24V
Q _{gd}	Gate-to-Drain ("Miller") Charge	—	17	25		V _{GS} = 4.5V ③
Q _{oss}	Output Gate Charge	—	23	34		V _{GS} = 0V, V _{DS} = 10V
t _{d(on)}	Turn-On Delay Time	—	15	—	ns	V _{DD} = 15V
t _r	Rise Time	—	99	—		I _D = 12A
t _{d(off)}	Turn-Off Delay Time	—	30	—		R _G = 6.8Ω
t _f	Fall Time	—	69	—		V _{GS} = 4.5V ③
C _{iss}	Input Capacitance	—	2430	—	pF	V _{GS} = 0V
C _{oss}	Output Capacitance	—	1200	—		V _{DS} = 15V
C _{rss}	Reverse Transfer Capacitance	—	250	—		f = 1.0MHz

Avalanche Characteristics

Symbol	Parameter	Typ.	Max.	Units
E _{AS}	Single Pulse Avalanche Energy②	—	310	mJ
I _{AR}	Avalanche Current①	—	30	A

Diode Characteristics

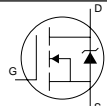
Symbol	Parameter	Min.	Typ.	Max.	Units	Conditions
I _S	Continuous Source Current (Body Diode)	—	—	110④	A	MOSFET symbol showing the integral reverse p-n junction diode. 
I _{SM}	Pulsed Source Current (Body Diode) ①	—	—	120		
V _{SD}	Diode Forward Voltage	—	0.75	1.3	V	T _J = 25°C, I _S = 12A, V _{GS} = 0V ③
		—	0.65	—		T _J = 125°C, I _S = 12A, V _{GS} = 0V ③
t _{rr}	Reverse Recovery Time	—	48	72	ns	T _J = 25°C, I _F = 12A, V _R = 15V
Q _{rr}	Reverse Recovery Charge	—	62	92	nC	di/dt = 100A/μs ③
t _{rr}	Reverse Recovery Time	—	49	74	ns	T _J = 125°C, I _F = 12A, V _R = 15V
Q _{rr}	Reverse Recovery Charge	—	67	100	nC	di/dt = 100A/μs ③

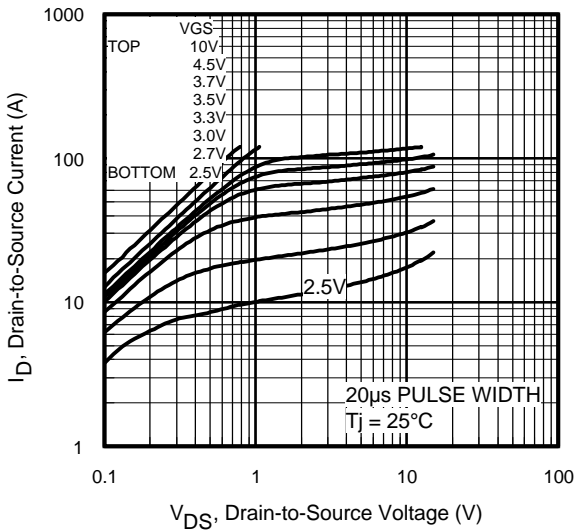

Fig 1. Typical Output Characteristics

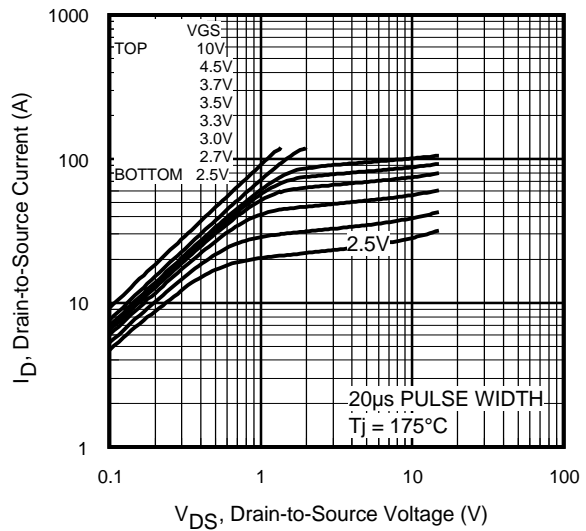

Fig 2. Typical Output Characteristics

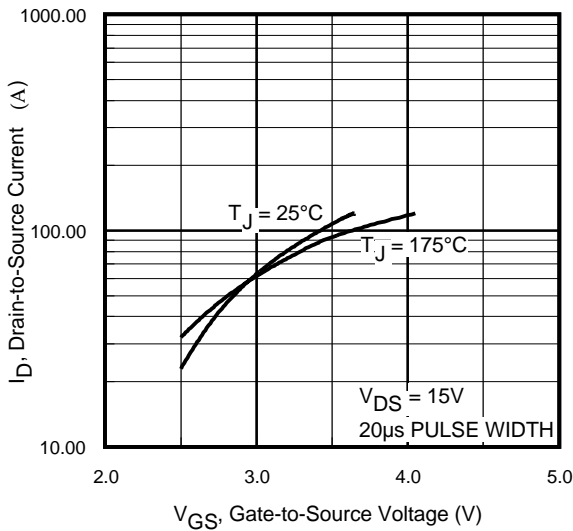

Fig 3. Typical Transfer Characteristics

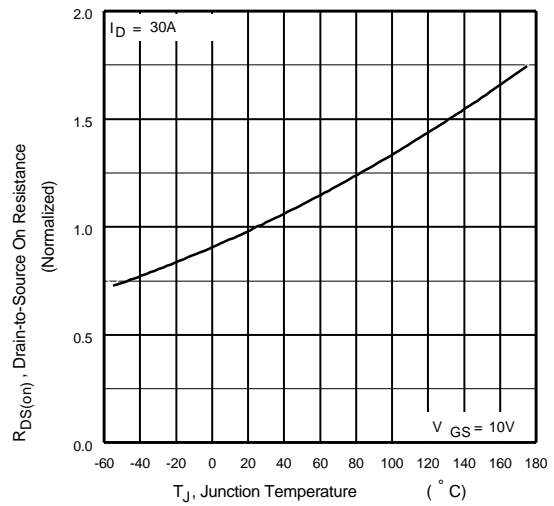

Fig 4. Normalized On-Resistance Vs. Temperature

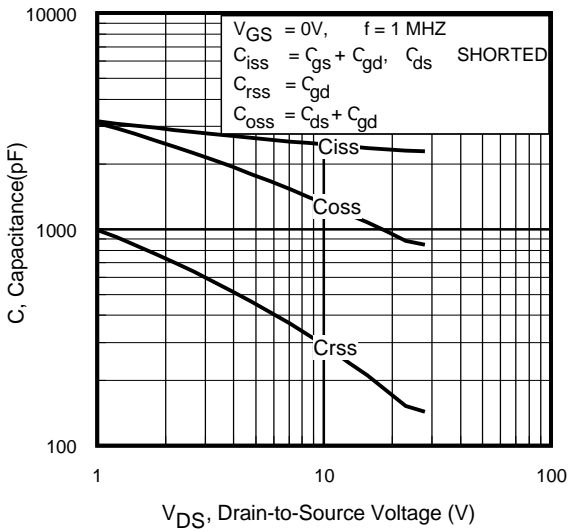

Fig 5. Typical Capacitance Vs. Drain-to-Source Voltage

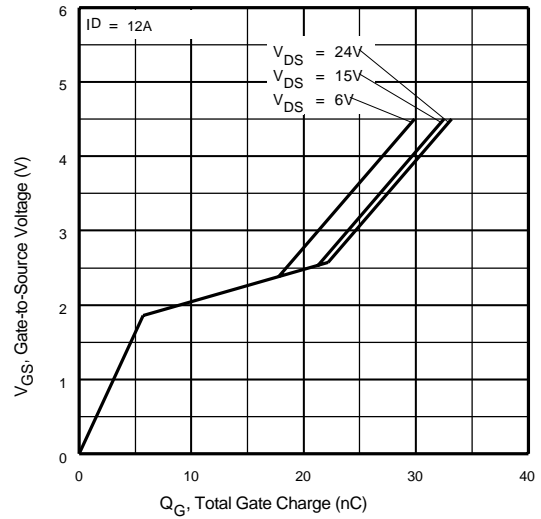

Fig 6. Typical Gate Charge Vs. Gate-to-Source Voltage

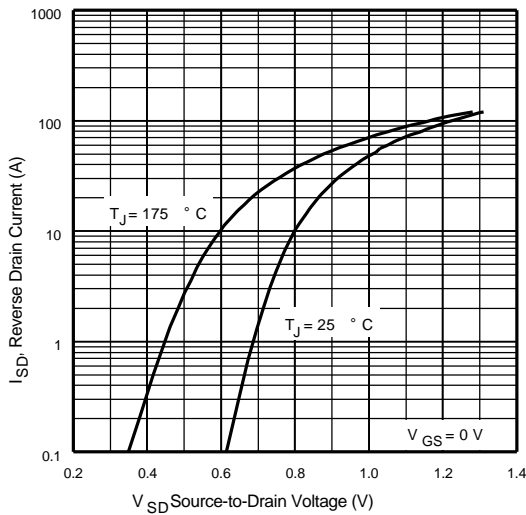

Fig 7. Typical Source-Drain Diode Forward Voltage

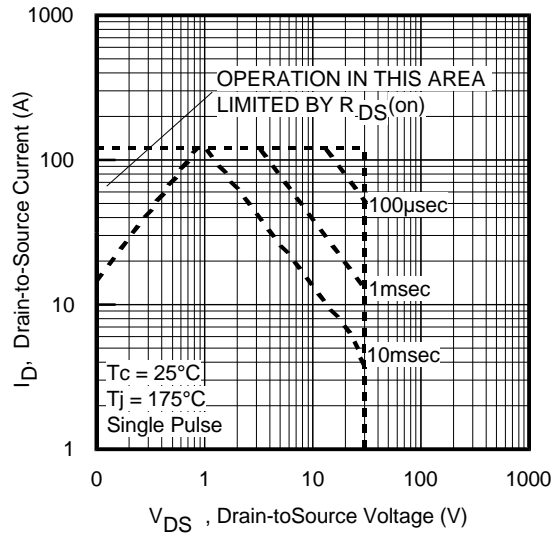

Fig 8. Maximum Safe Operating Area

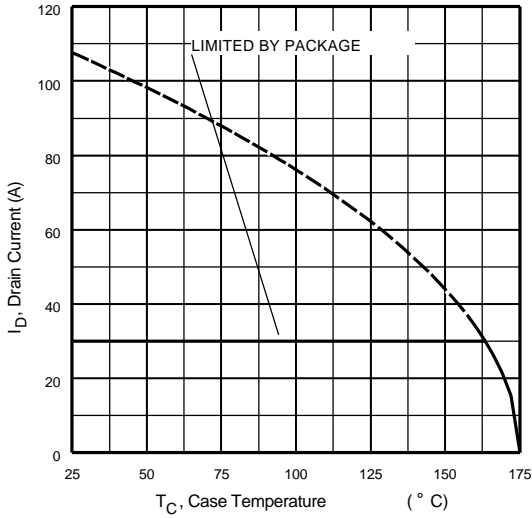

Fig 9. Maximum Drain Current Vs. Case Temperature

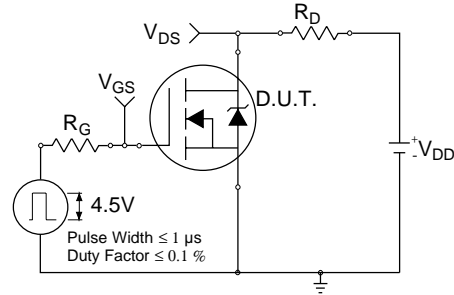

Fig 10a. Switching Time Test Circuit

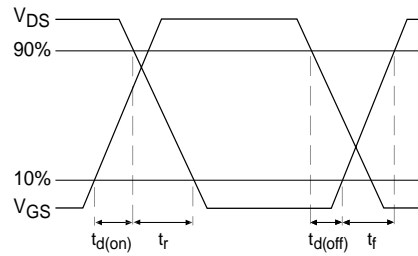

Fig 10b. Switching Time Waveforms

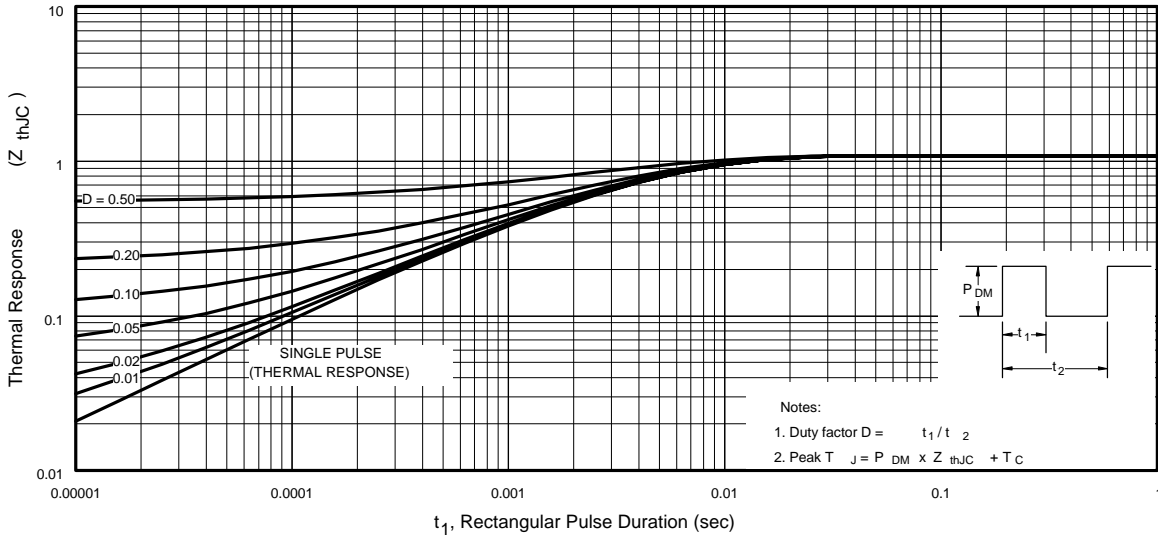

Fig 11. Maximum Effective Transient Thermal Impedance, Junction-to-Case

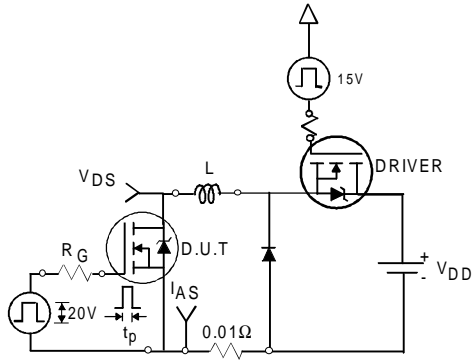

Fig 12a. Unclamped Inductive Test Circuit



Fig 12b. Unclamped Inductive Waveforms

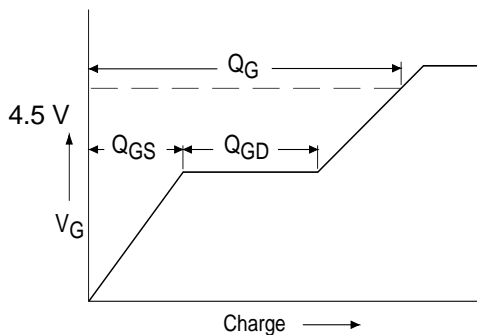

Fig 13a. Basic Gate Charge Waveform

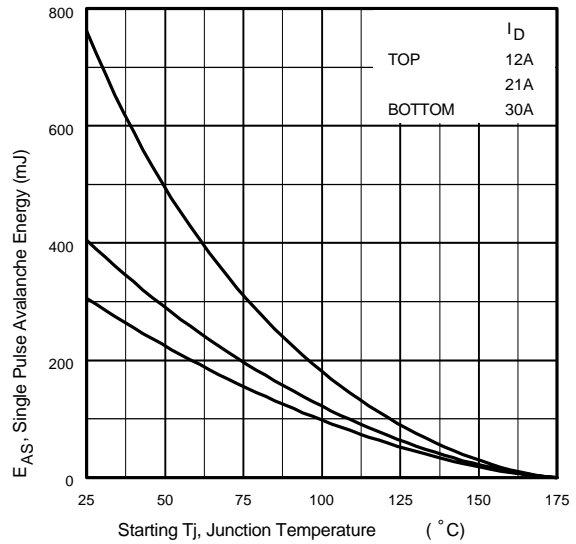

Fig 12c. Maximum Avalanche Energy Vs. Drain Current

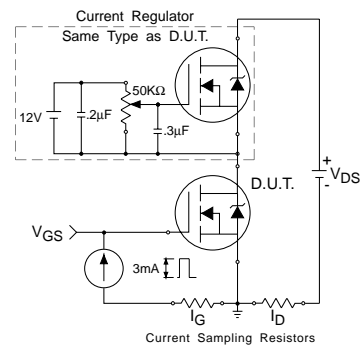
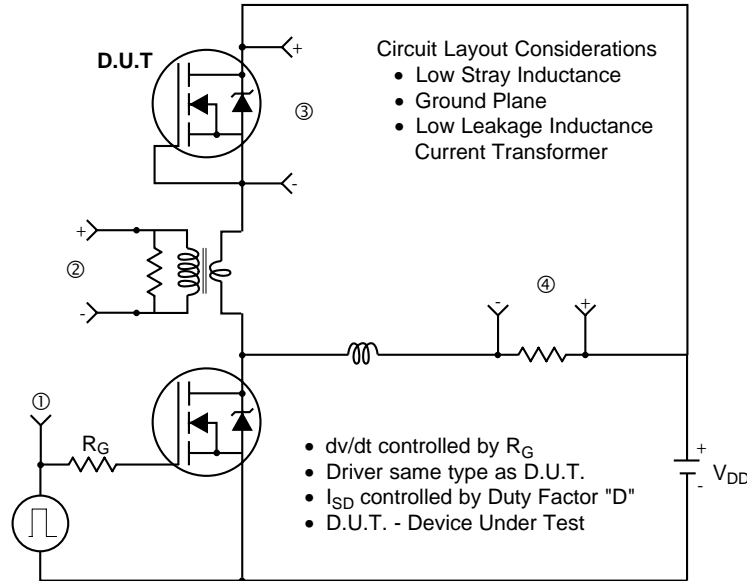

Fig 13b. Gate Charge Test Circuit

Peak Diode Recovery dv/dt Test Circuit



* $V_{GS} = 5V$ for Logic Level Devices

Fig 14. For N-Channel HEXFET® Power MOSFETs

IRLR/U8203

D-Pak (TO-252AA) Package Outline

Dimensions are shown in millimeters (inches)

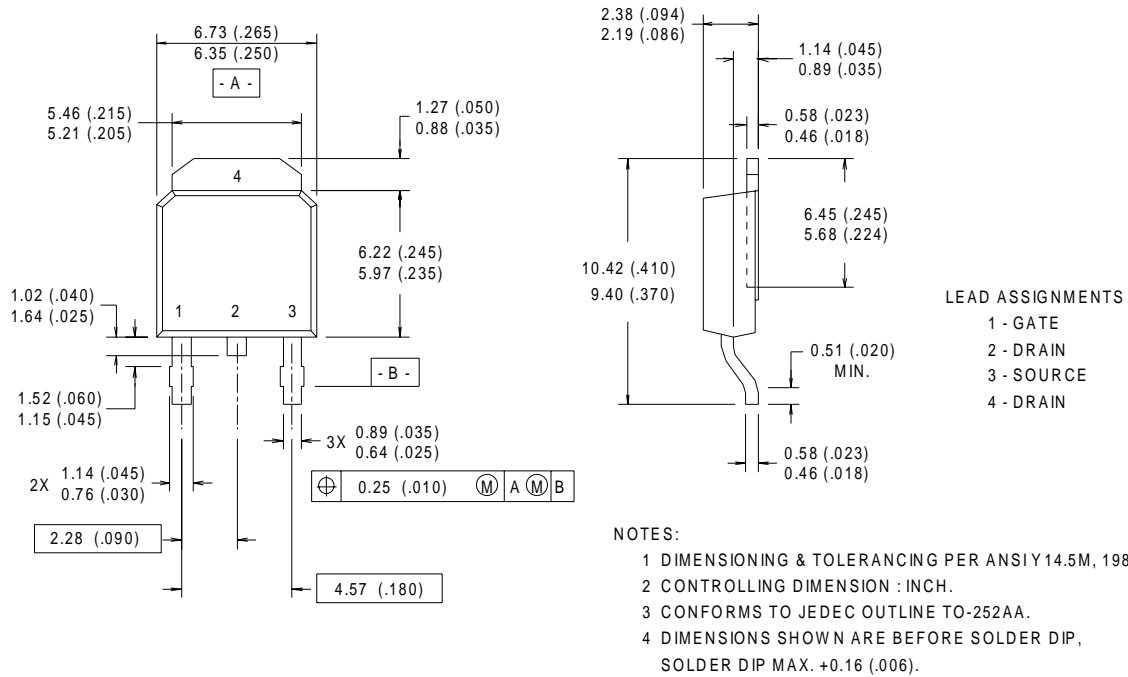

D-Pak (TO-252AA) Part Marking Information

EXAMPLE: THIS IS AN IRFR120
WITH ASSEMBLY
LOT CODE 1234
ASSEMBLED ON WW 16, 1999
IN THE ASSEMBLY LINE "A"

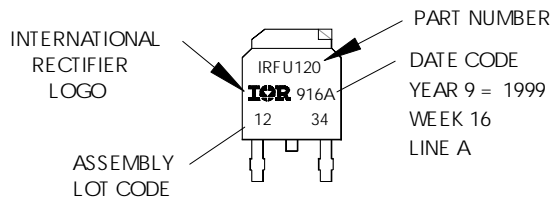

I-Pak (TO-251AA) Package Outline

Dimensions are shown in millimeters (inches)

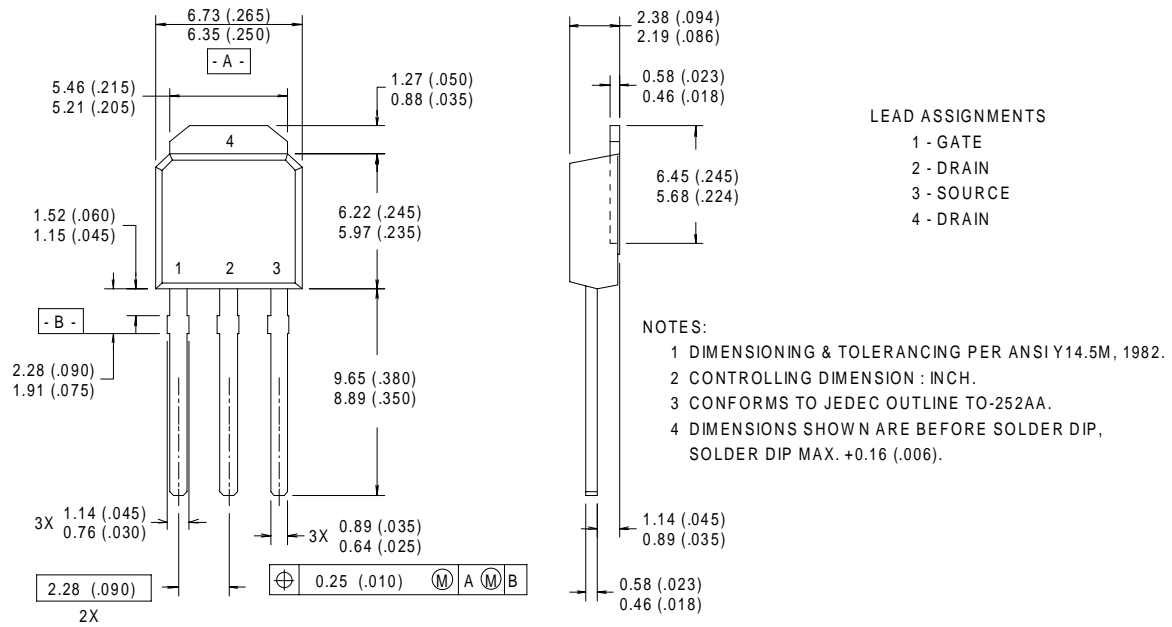

I-Pak (TO-251AA) Part Marking Information

EXAMPLE: THIS IS AN IRFR120
 WITH ASSEMBLY
 LOT CODE 5678
 ASSEMBLED ON WW 19, 1999
 IN THE ASSEMBLY LINE "A"

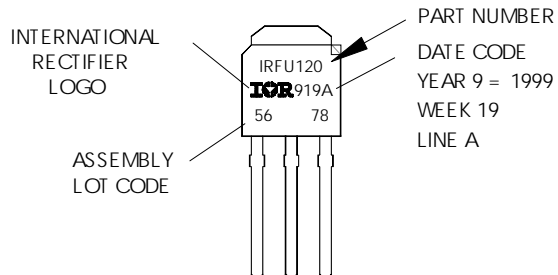

IRLR/U8203

International
IR Rectifier

D-Pak (TO-252AA) Tape & Reel Information

Dimensions are shown in millimeters (inches)

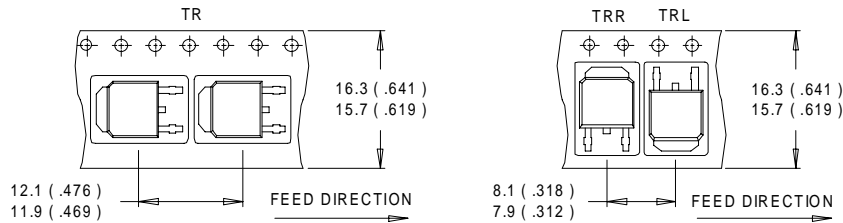

NOTES :

1. CONTROLLING DIMENSION : MILLIMETER.
2. ALL DIMENSIONS ARE SHOWN IN MILLIMETERS (INCHES).
3. OUTLINE CONFORMS TO EIA-481 & EIA-541.

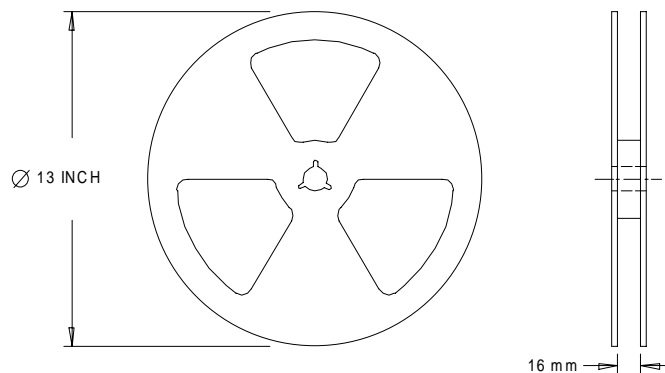

NOTES :

1. OUTLINE CONFORMS TO EIA-481.

Notes:

- ① Repetitive rating; pulse width limited by max. junction temperature.
- ② Starting $T_J = 25^\circ\text{C}$, $L = 0.68\text{mH}$
 $R_G = 25\Omega$, $I_{AS} = 30\text{A}$.
- ③ Pulse width $\leq 400\mu\text{s}$; duty cycle $\leq 2\%$.
- ④ Calculated continuous current based on maximum allowable junction temperature. Package limitation current is 30A.

Data and specifications subject to change without notice.
This product has been designed and qualified for the Industrial market.
Qualification Standards can be found on IR's Web site.

International
IR Rectifier

IR WORLD HEADQUARTERS: 233 Kansas St., El Segundo, California 90245, USA Tel: (310) 252-7105
TAC Fax: (310) 252-7903

Visit us at www.irf.com for sales contact information.03/02

www.irf.com