

800MHz Band FRONT-END GaAs MMIC

■GENERAL DESCRIPTION

NJG1720PB1 is a front-end GaAs MMIC including a Dual LNA, inverter, a local amplifier and a mixer, designed mainly for 800MHz band cellular phone handsets. The LNAs switching is made by 2 bit control signal by using inverter circuit included in this IC.

The ultra small and thin FFP12-B1 is applied.

■PACKAGE

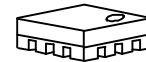

NJG1720PB1

■FEATURES

- | | | |
|--------------------------|------------|--|
| ●Low Voltage Operation | +2.8V typ. | |
| ●Low Current Consumption | +8.7mA typ | |
| ●Low Control Current | 20uA typ. | |
- | | | | |
|-------------------|--|-----------------------|---|
| [LNA] | | [Mixer] | |
| ●High gain | 17.5dB typ. @f=830MHz
17.5dB typ. @f=840MHz | ●High conversion gain | 11.5dB typ. @f=840MHz |
| ●Low noise figure | 1.5dB typ. @f=830MHz
1.5dB typ. @f=840MHz | ●Low noise figure | 5.5dB typ. @f=840MHz |
| ●High input IP3 | -7dBm typ. @f=830.0+830.1MHz
-7dBm typ. @f=840.0+840.1MHz | ●High input IP3 | 3.0dBm typ.
@f=840.0+840.1MHz |
| | | ●High RF to LO ISL | 35dB typ.
@ f _{MIXIN} =840MHz, P _{MIXIN} =0dBm |
- Ultra small & thin package FFP12-B1 (Package size: 2.0x2.0x0.85mm)

■PIN CONFIGURATION (Top View)

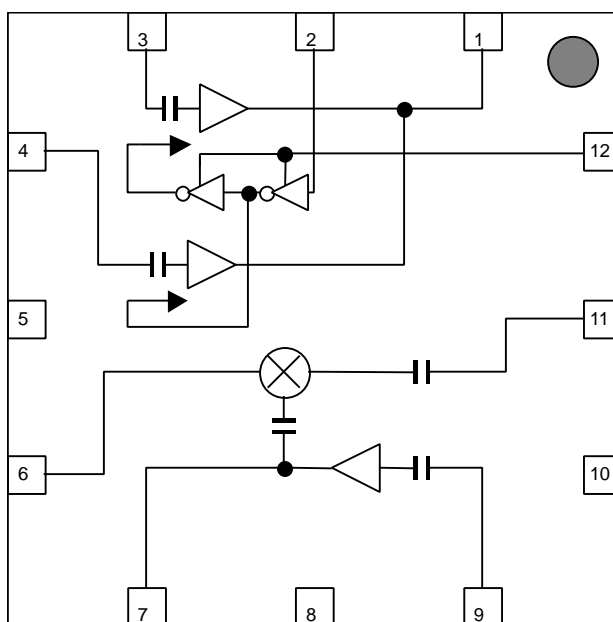

Pin Connection

1. LNAOUT
2. VCTL
3. LNAIN2(Full Band)
4. LNAiN1(CD Band)
5. GND
6. IFOUT
7. VLO
8. GND
9. LOIN
10. GND
11. MIXIN
12. VINV

NOTE: Please note that any information on this catalog will be subject to change.

NJG1720PB1

■ABSOLUTE MAXIMUM RATINGS

($T_a=+25^{\circ}\text{C}$, $Z_s=Z_l=50\Omega$)

PARAMETER	SYMBPL	CONDITIONS	RATINGS	UNITS
LNA Voltage	V_{LNA}		5.0	V
MIXER Voltage	V_{MIXER}		5.0	V
LOCAL AMP Voltage	V_{LO}		5.0	V
Inverter supply voltage	V_{INV}		5.0	V
Control Voltage	V_{CTL}		V_{INV}	V
Input Power 1	Pin1	$V_{LNA}=2.8\text{V}$ LNAIN1, LNAIN2 ports	+15	dBm
Input Power 2	Pin2	$V_{MIX}, V_{LO}=2.8\text{V}$ RFIN, LOIN ports	+10	dBm
Power Dissipation	P_D		300	mW
Operating Temperature	T_{opr}		-40~+85	$^{\circ}\text{C}$
Storage Temperature	T_{stg}		-55~+150	$^{\circ}\text{C}$

■ELECTRICAL CHARACTERISTICS 1(DC CHARACTERISTICS)

GENERAL CONDITIONS:: $T_a=+25^{\circ}\text{C}$, $Z_s=Z_l=50\Omega$, $V_{DD}=V_{INV}=2.8\text{V}$

PARAMETER	SYMBOL	CONDITIONS	MIN	TYP	MAX	UNITS
LNA Voltage	V_{LNA}		2.5	2.8	4.5	V
LNA Operating Current	$I_{LNA1,2}$	RF OFF,	-	2.8	3.5	mA
Inverter supply voltage	V_{INV}		2.5	2.8	4.5	V
Inverter current	I_{INV}	RF OFF	-	100	150	μA
Control voltage (High)	$V_{CTL1(H)}$		2.0	2.4	V_{INV}	V
Control voltage (Low)	$V_{CTL1(L)}$	VCTL Terminal	0.0	0.0	0.8	V
Control current	I_{CTL}	VCTL Terminal	-	20	60	μA
Mixer Voltage	V_{MIX}	IFOUT Terminal	2.5	2.8	4.5	V
Local Amplifier Voltage	V_{LO}	VLO Terminal	2.5	2.8	4.5	V
Mixer Current	I_{MIX}	IFOUT Terminal, $P_{RF}=P_{LO}=\text{OFF}$,	-	4.9	6.1	mA
Local Amplifier Current	I_{LO}	VLO Terminal, $P_{RF}=P_{LO}=\text{OFF}$,	-	1.0	1.2	mA

■ELECTRICAL CHARACTERISTICS (LNA1 RF CHARACTERISTICS)

GENERAL CONDITIONS: $T_a=+25^{\circ}\text{C}$, $Z_s=Z_l=50\Omega$, $V_{DD}=V_{INV}=2.8\text{V}$, $V_{CTL}=0\text{V}$,
with test circuit

PARAMETER	SYMBOL	CONDITIONS	MIN	TYP	MAX	UNITS
Operating Frequency	freq		810	830	843	MHz
Small Signal Gain	Gain		16.5	17.5	19.0	dB
Gain Flatness	G_{flat}	freq=810~843MHz	-	0.5	1.0	dB
Noise Figure	NF	Loss of PCB and connector are excluded	-	1.5	1.7	dB
Pin at 1dB Gain Compression point	$P_{-1dB(IN)}$		-21.0	-18.0	-	dBm
Input 3rd Order Intercept Point	IIP3	2 tone offset frequency=100kHz, $P_{RF}=-36\text{dBm}$	-10.0	-7.0	-	dBm
Isolation	ISO	freq=675.15 to 750.15MHz	25	30	-	dB
Input VSWR	$VSWR_i$		-	1.5	2.0	-
Output VSWR	$VSWR_o$		-	1.5	2.0	-

■ELECTRICAL CHARACTERISTICS (LNA2 RF CHARACTERISTICS)

GENERAL CONDITIONS: $T_a=+25^{\circ}\text{C}$, $Z_s=Z_l=50\Omega$, $V_{DD}=V_{INV}=2.8\text{V}$, $V_{CTL}=2.4\text{V}$
with test circuit

PARAMETER	SYMBOL	CONDITIONS	MIN	TYP	MAX	UNITS
Operating Frequency	freq		810	840	885	MHz
Small Signal Gain	Gain		16.5	17.5	18.5	dB
Gain Flatness	G_{flat}	freq=810~885MHz	-	0.5	1.2	dB
Noise Figure	NF	Loss of PCB and connector are excluded	-	1.5	1.7	dB
Pin at 1dB Gain Compression point	$P_{-1dB(IN)}$		-21.0	-18.0	-	dBm
Input 3rd Order Intercept Point	IIP3	2 tone offset frequency=100kHz, $P_{RF}=-36\text{dBm}$	-10.0	-7.0	-	dBm
Isolation	ISO	freq=675.15 to 750.15MHz	25	30	-	dB
Input VSWR	$VSWR_i$		-	1.5	2.0	-
Output VSWR	$VSWR_o$		-	1.5	2.0	-

NJG1720PB1

■ELECTRICAL CHARACTERISTICS (Mixer RF CHARACTERISTICS)

GENERAL CONDITIONS: $T_a=+25^{\circ}\text{C}$, $V_{\text{MIX}}=V_{\text{LO}}=2.8\text{V}$, $f_{\text{MIXIN}}=840\text{MHz}$, $P_{\text{MIXIN}}=-30\text{dBm}$,
 $f_{\text{LOIN}}=705.15\text{MHz}$, $P_{\text{LOIN}}=-15\text{dBm}$, $f_{\text{IF}}=134.85\text{MHz}$, $Z_s=Z_l=50\Omega$,
 with test circuit

PARAMETER	SYMBOL	CONDITIONS	MIN	TYP	MAX	UNITS
Operating Frequency	Freq		810	820	885	MHz
Conversion Gain	Gain		10.0	11.5	12.5	dB
Noise Figure	NF	SSB NF	-	5.5	6.5	dB
Input 3rd Order Intercept Point	IIP3	2 tone offset frequency=100kHz	0	+3.0	-	dBm
Pin at 1dB Gain Compression point	$P_{-1\text{dB(IN)}}$		-11.0	-9.0	-	dBm
Local Leakage	Pleak	LOCAL IN PORT to RF IN PORT	-	-23.0	-18.0	dBm
Local Amplifier Isolation	LOISL	RF IN PORT to LOCAL IN PORT, $P_{\text{RF}}=0\text{dBm}$	20.0	35.0	-	dB
RF IN1 port VSWR	VSWR1		-	2.0	3.0	
LOCAL IN1 port VSWR	VSWR2		-	1.5	2.0	

■TRUTH TABLE

“H”= $V_{\text{CTL(H)}}$ “L”= $V_{\text{CTL(L)}}$

VCTL	L	H
LNA1 (CD Band: 810~843MHz)	ON	OFF
LNA2 (Full Band: 810~885MHz)	OFF	ON

■ TERMINAL INFORMATION

No.	Symbol	Description
1	LNAOUT	Output terminal. This is the power supply terminal of the LNA. Please use inductor(L5) to connect power supply.(Please see test circuit.)
2	VCTL	Control voltage input terminal. This terminal is set to Full band and CD band to select.
3	LNAIN2	Input terminal of full band. The DC blocking capacitor is not required.
4	LNAIN1	Input terminal of CD band. The DC blocking capacitor is not required.
5	GND	Ground terminal (0V)
6	IFOUT	IF signal output terminal. The IF signal is output through external matching circuit connected to this terminal. Please connect inductances C4, L9 and power supply as shown in test circuits, since this terminal is also the terminal of mixer power supply.
7	VLO	Power supply terminal for local amplifier. Please place L8 shown in test circuits at very close to this terminal.
8	GND	Ground terminal (0V)
9	LOIN	Local signal input terminal to local amplifier. An external matching circuit is required.
10	GND	Ground terminal (0V)
11	MIXIN	RF signal input terminal to mixer. An external matching circuit is required.
12	VINV	Power supply terminal of the inverter circuit.

NOTE:

- 1) Ground terminal (5, 8, 10pin) should be connected to ground plane by multiple via holes for good grounding.

NJG1720PB1

■ TYPICAL CHARACTERISTICS 1 (LNA1)

NF, Gain vs. freq

($V_{LNA} = V_{INV} = 2.8V, V_{CTL} = 0V, Ta = 25^{\circ}C$)

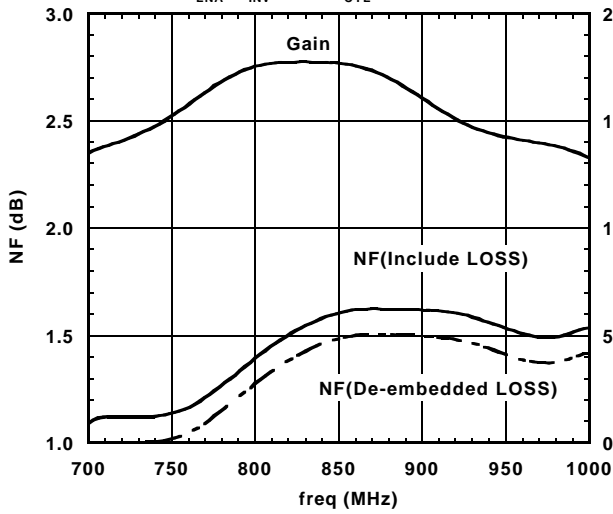

Pout, Gain vs. Pin

($V_{LNA} = V_{INV} = 2.8V, V_{CTL} = 0V, f_{RF} = 830MHz, Ta = 25^{\circ}C$)

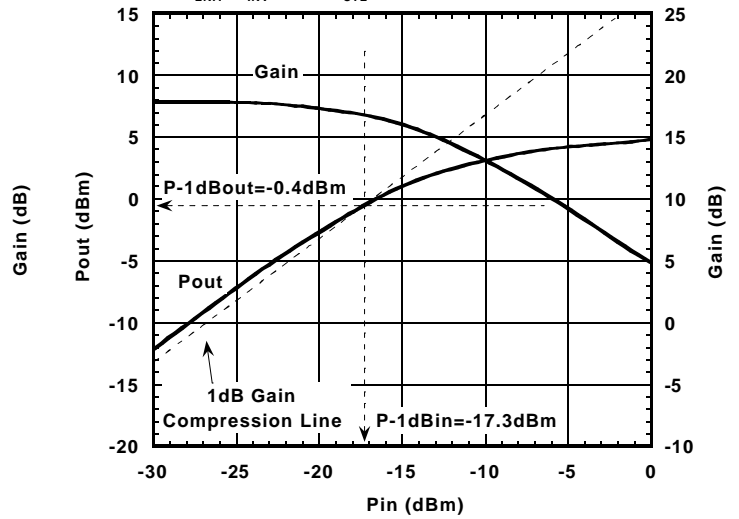

Pout, IM3 vs. Pin

($V_{LNA} = V_{INV} = 2.8V, V_{CTL} = 0V, f_{RF} = 830+830.1MHz, Ta = 25^{\circ}C$)

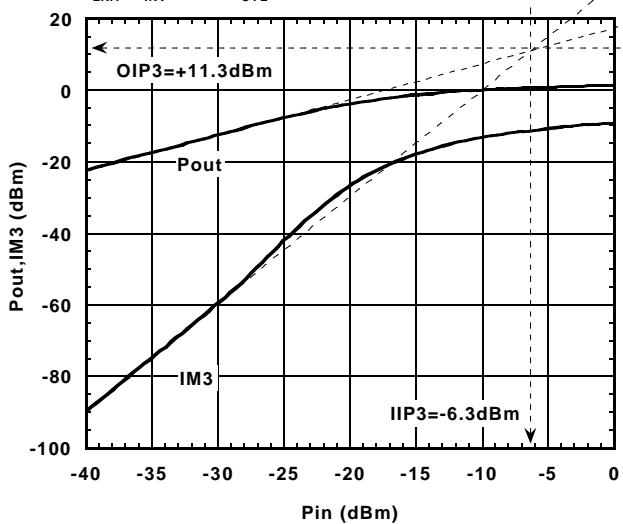

IIP3, OIP3 vs. freq

($V_{LNA} = V_{INV} = 2.8V, V_{CTL} = 0V, df_{RF} = 100kHz, PRF = -36dBm, Ta = 25^{\circ}C$)

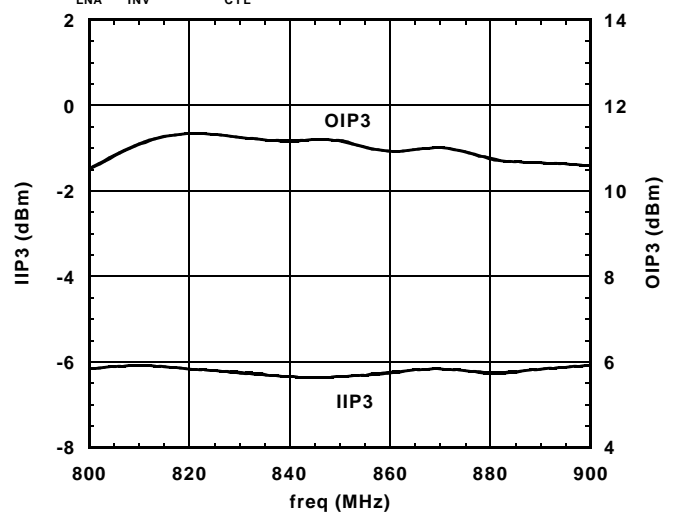

Gain, NF vs. V_{LNA}

($V_{INV} = 2.8V, V_{CTL} = 0V, f_{RF} = 830MHz$)

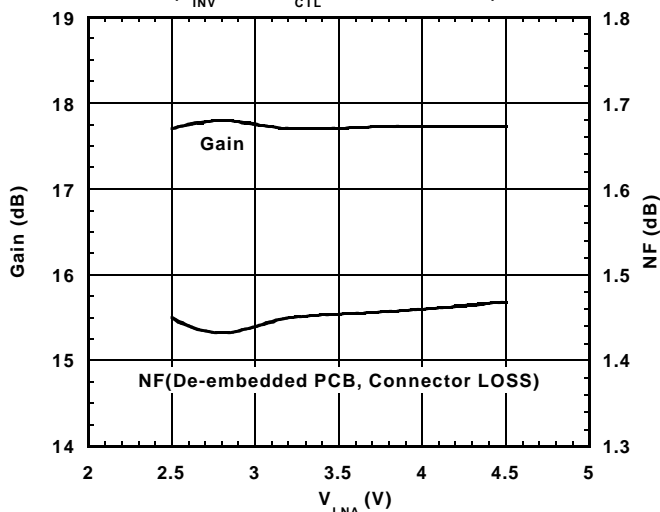

I_{LNA} vs. V_{LNA}

($V_{INV} = 2.8V, V_{CTL} = 0V, RF OFF$)

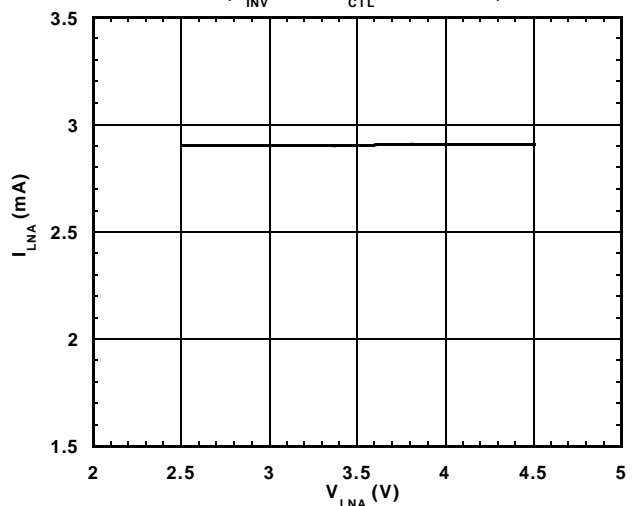

TYPICAL CHARACTERISTICS 2(LNA1)

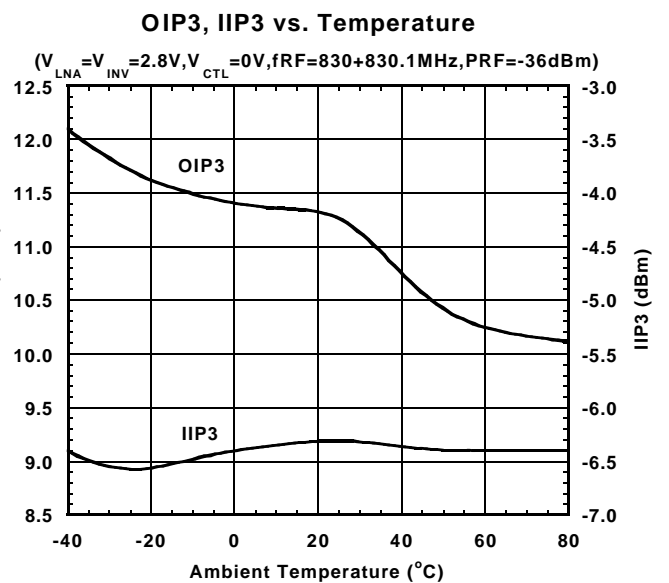
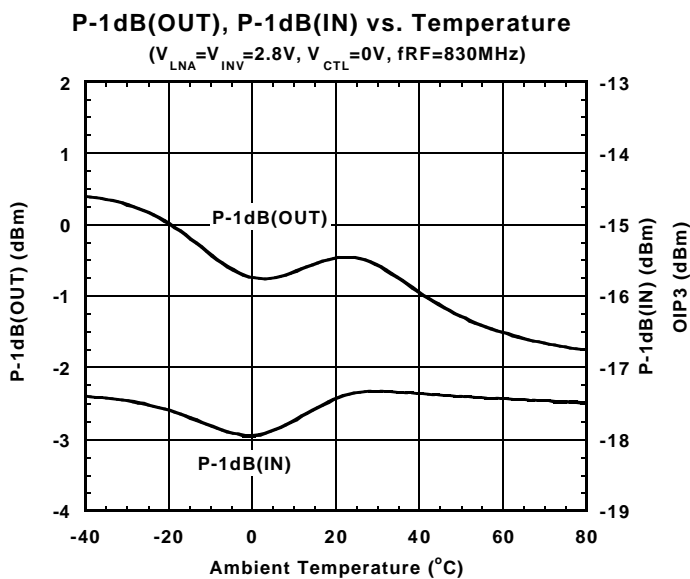
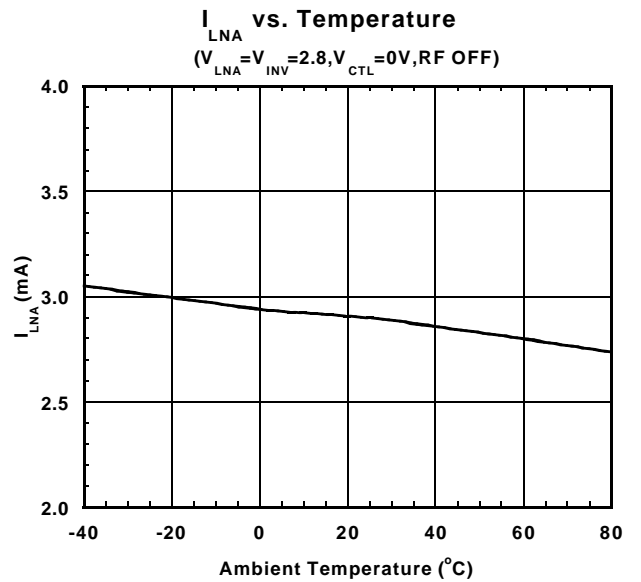
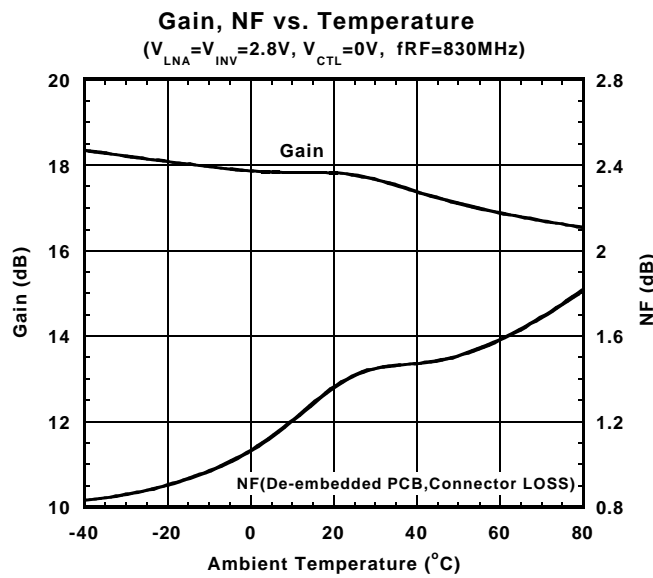
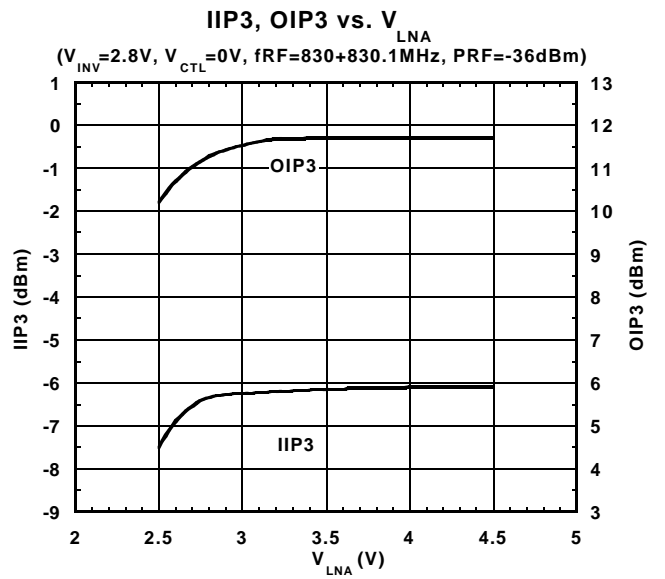
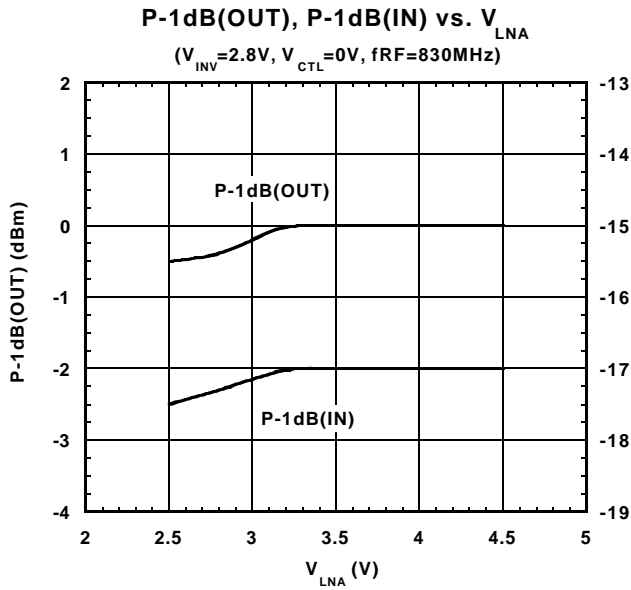

NJG1720PB1

TYPICAL CHARACTERISTICS 3(LNA1)

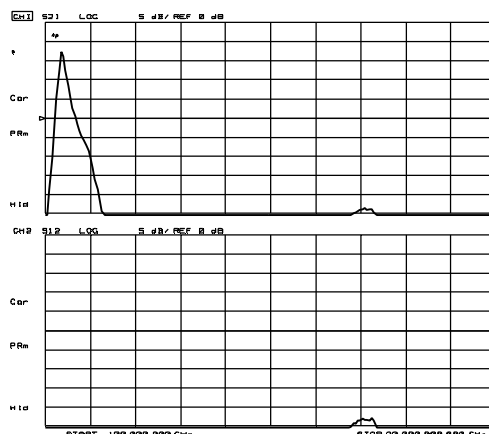
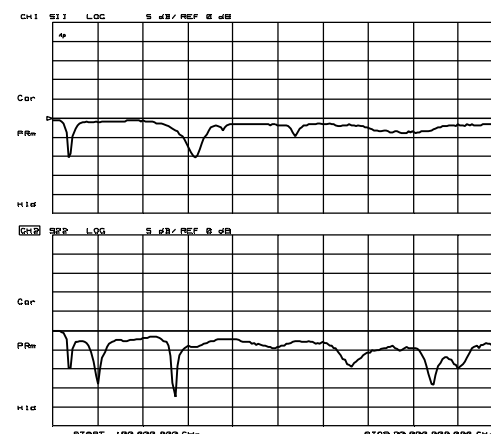
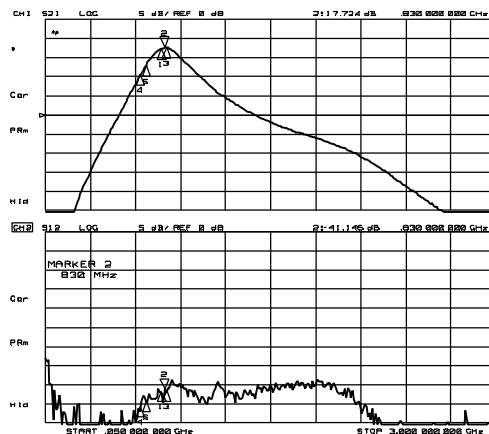
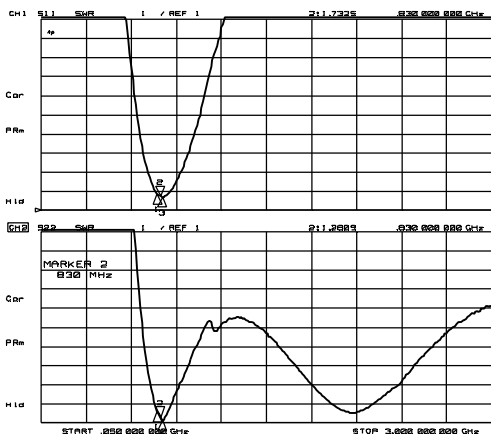
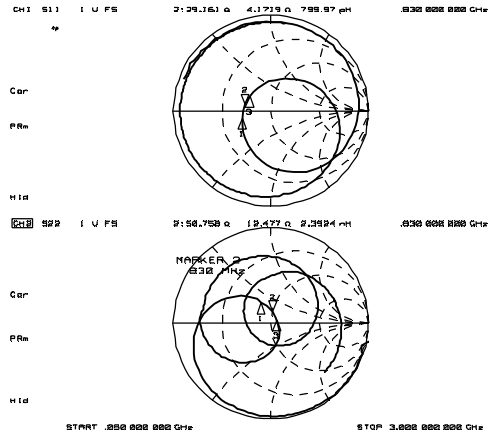
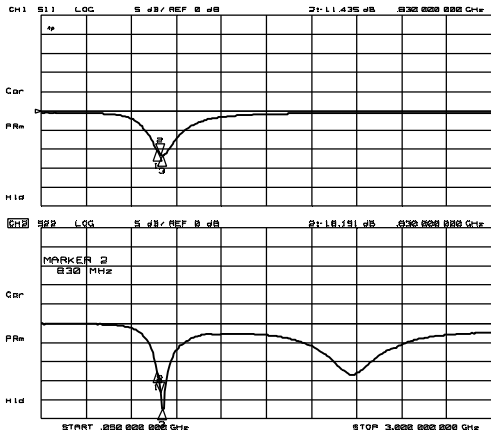

■ TYPICAL CHARACTERISTICS 4(LNA2)

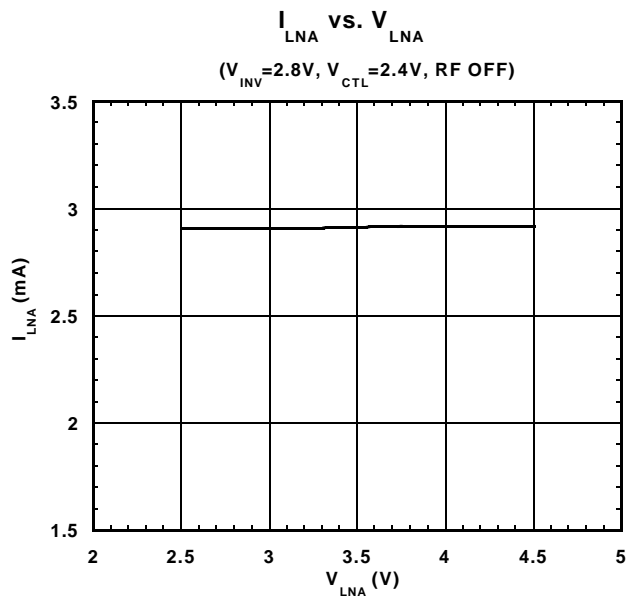
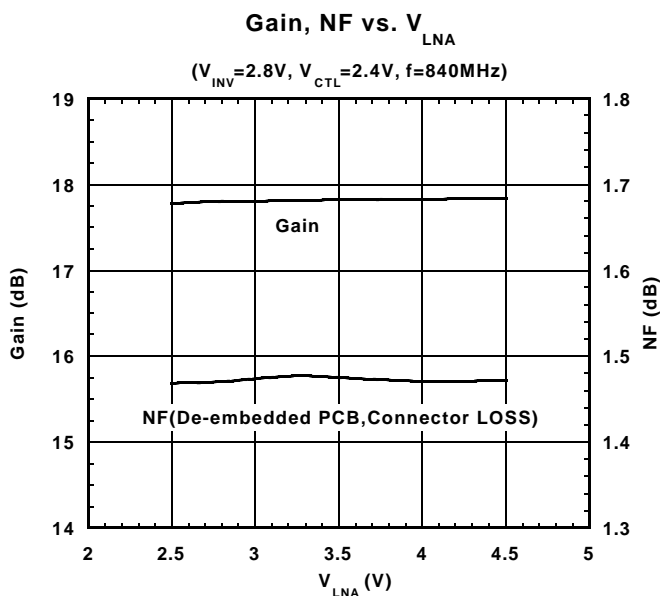
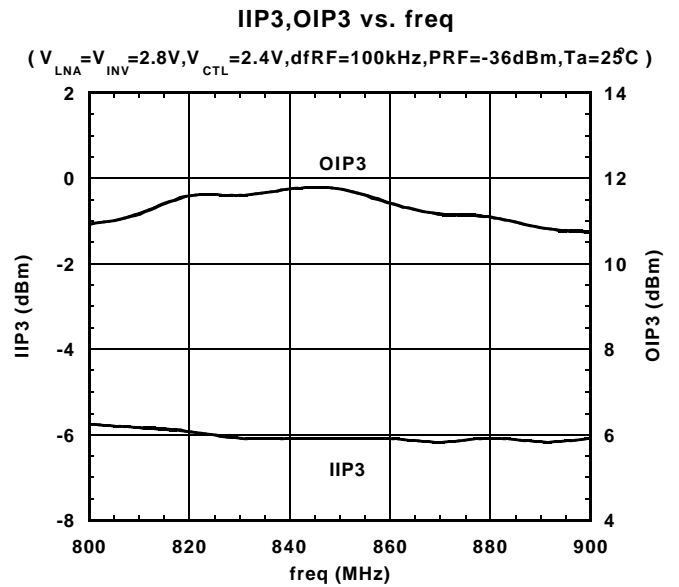
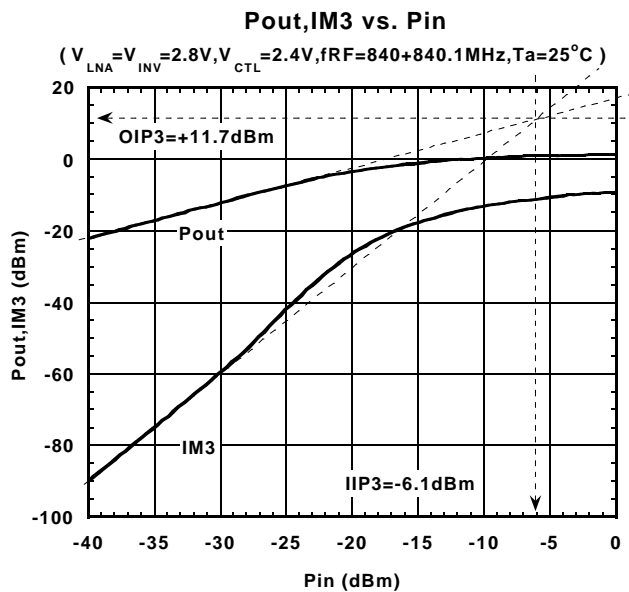
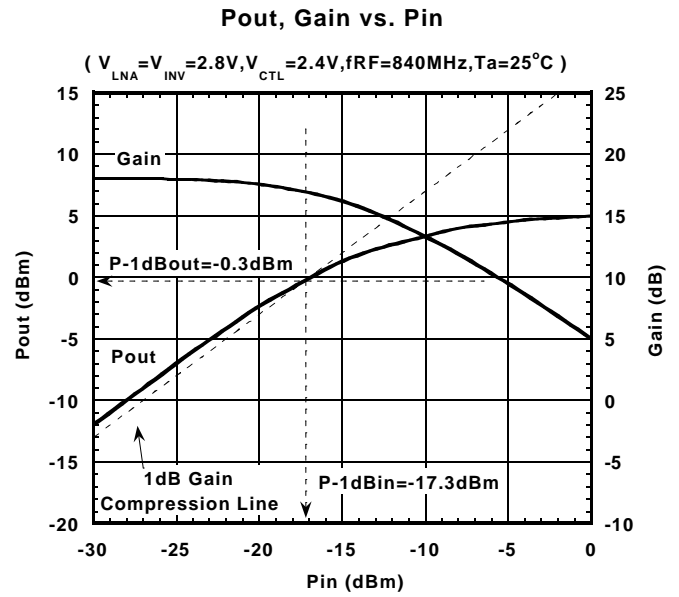
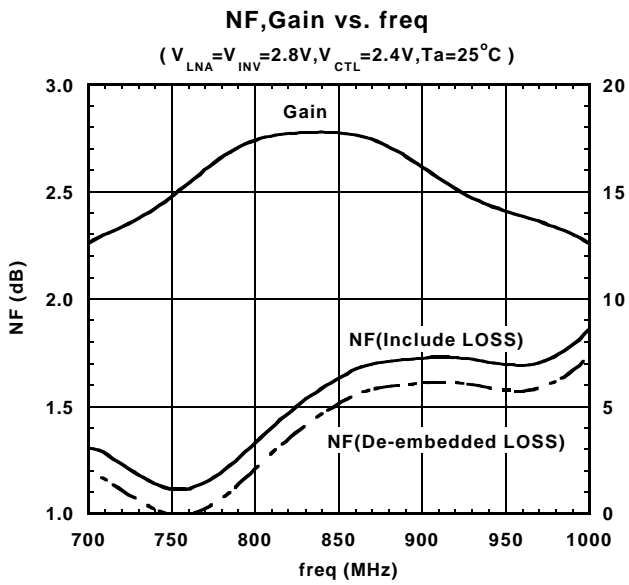

NJG1720PB1

TYPICAL CHARACTERISTICS 5(LNA2)

P-1dB(OUT), P-1dB(IN) vs. V_{LNA}

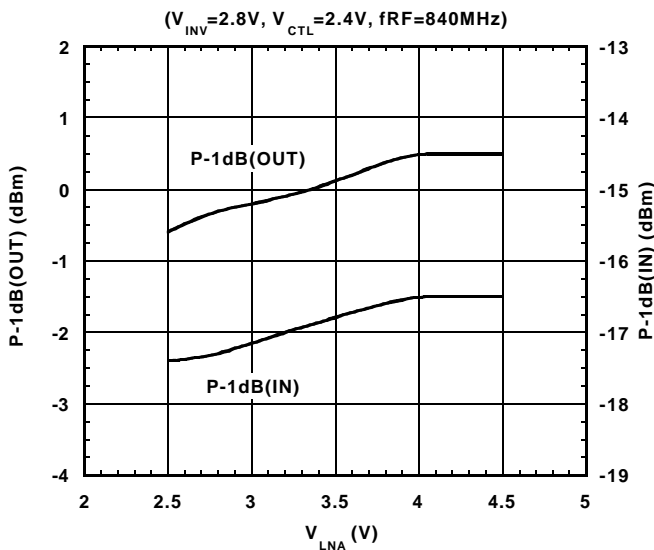

IIP3, OIP3 vs. V_{LNA}

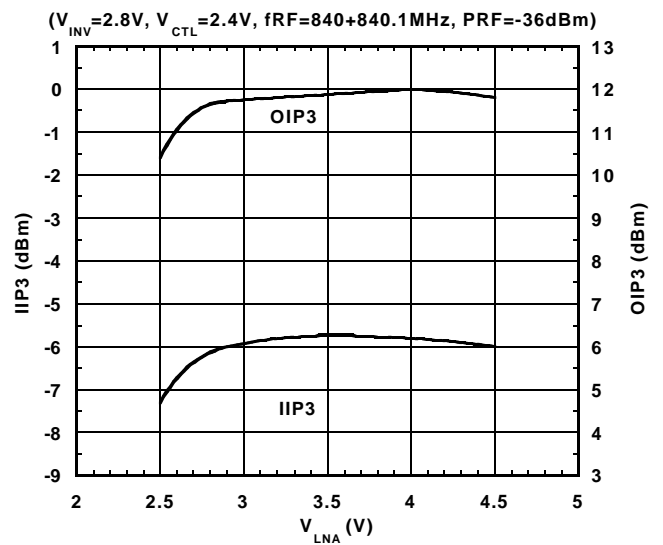

Gain, NF vs. Temperature

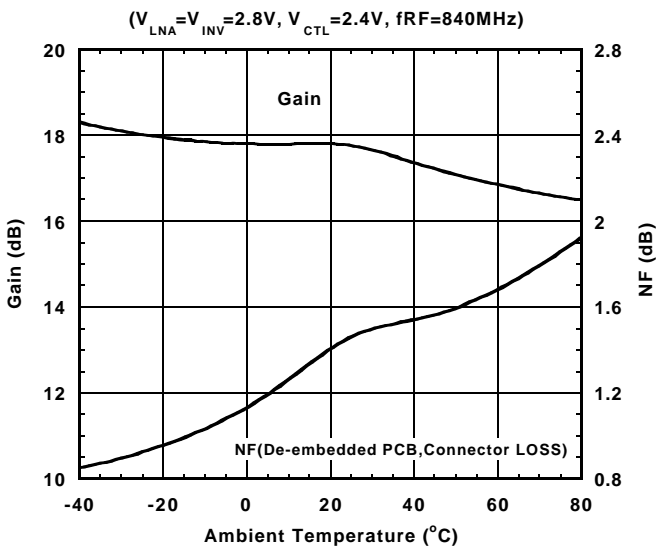

I_{LNA} vs. Temperature

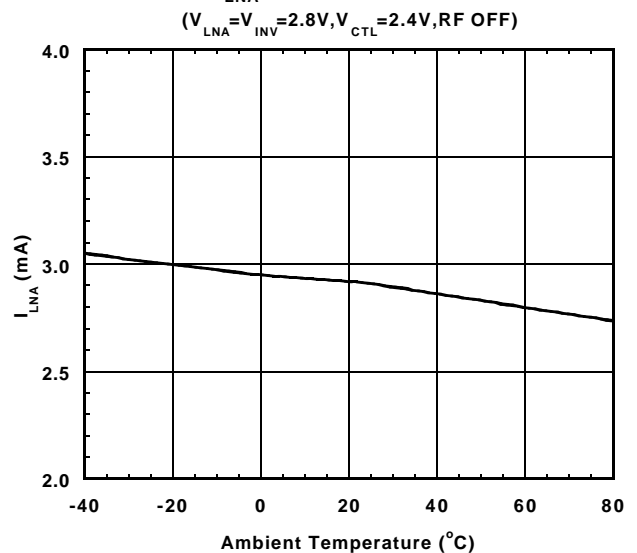

P-1dB(OUT), P-1dB(IN) vs. Temperature

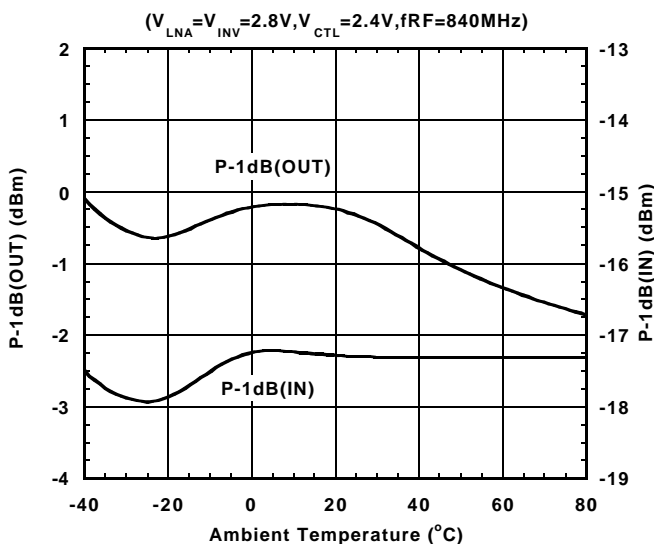

OIP3, IIP3 vs. Temperature

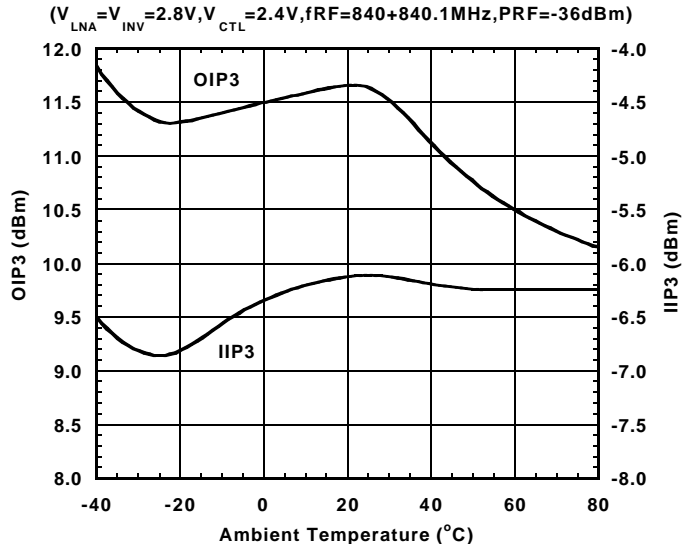

TYPICAL CHARACTERISTICS 6(LNA2)

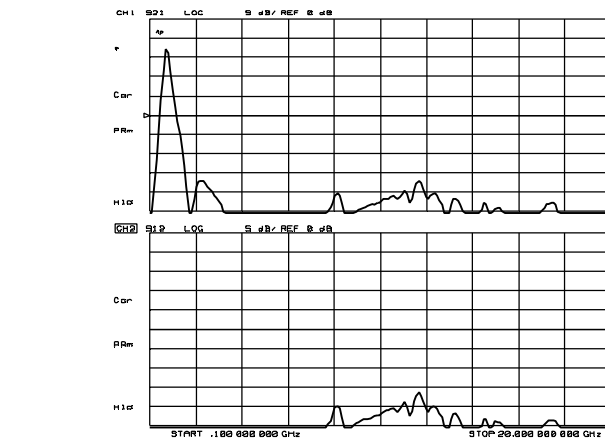
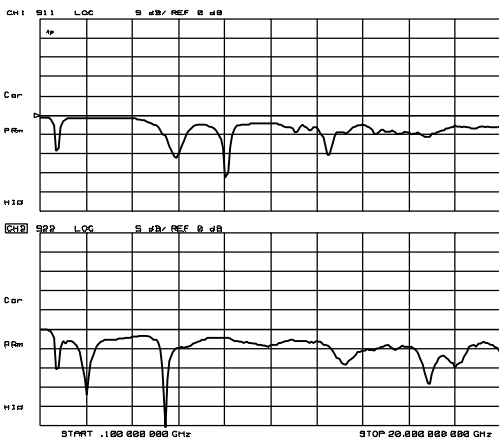
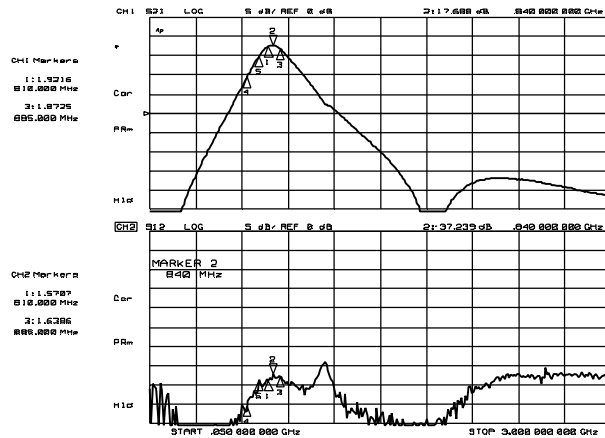
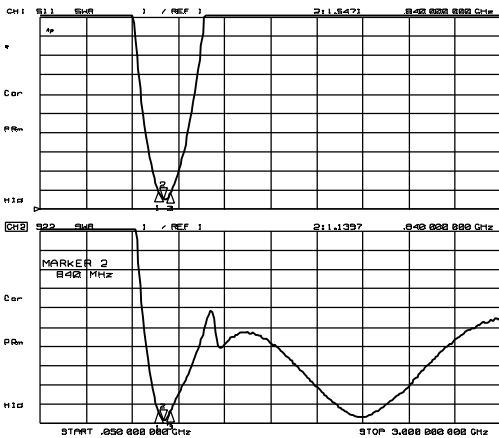
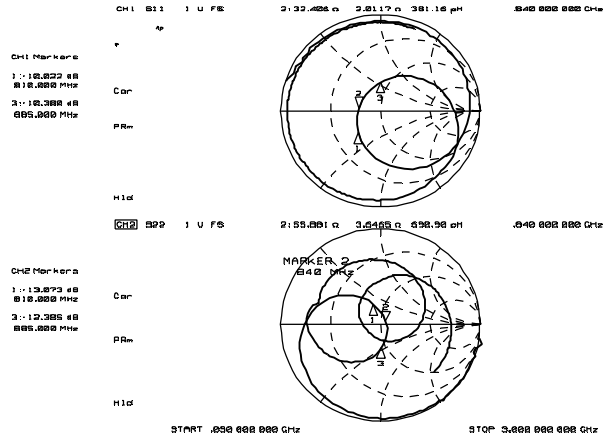
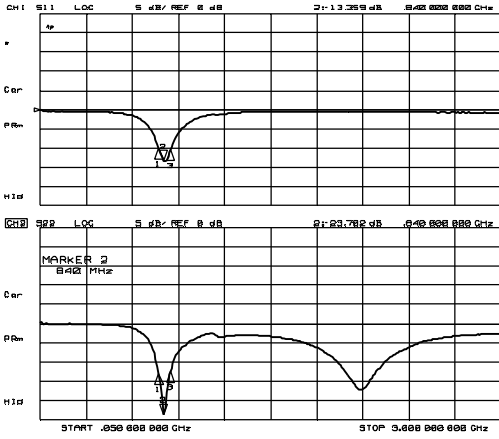

NJG1720PB1

■ TYPICAL CHARACTERISTICS 7(Mixer)

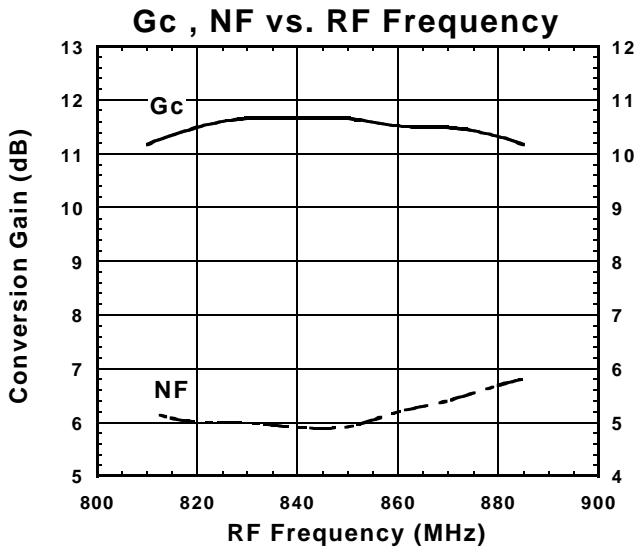

Condition
 $f_{IF}=134.85\text{MHz}$
 $f_{RF}=810\sim 885\text{MHz}$, $P_{RF}=-30\text{dBm}$
 $f_{LO}=675.15\sim 750.15\text{MHz}$, $P_{LO}=-15\text{dBm}$
 $V_{MIX}=V_{LO}=2.8\text{V}$

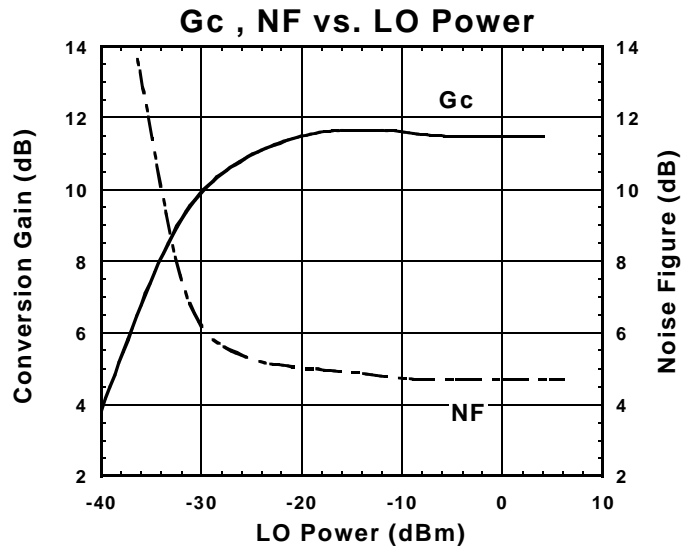

Condition
 $f_{IF}=134.85\text{MHz}$
 $f_{RF}=840\text{MHz}$, $P_{RF}=-30\text{dBm}$
 $f_{LO}=705.15\text{MHz}$
 $V_{MIX}=V_{LO}=2.8\text{V}$

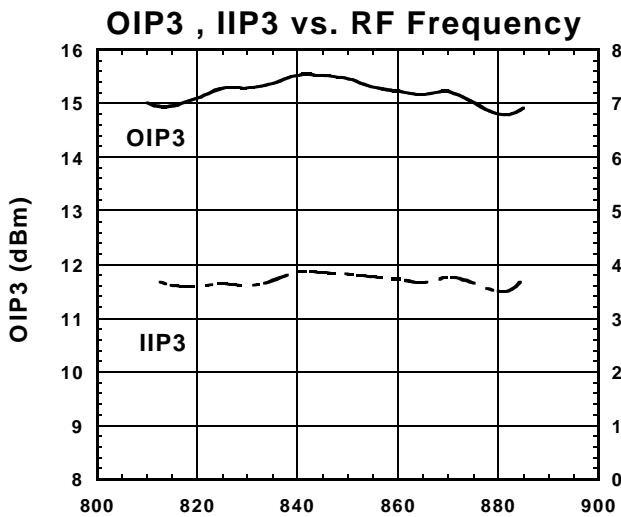

Condition
 $f_{IF}=134.85\text{MHz}$
 $f_{RF1}=810\sim 885\text{MHz}$
 $f_{RF2}=f_{RF1}+100\text{kHz}$, $P_{RF}=-30\text{dBm}$
 $f_{LO}=675.15\sim 750.15\text{MHz}$, $P_{LO}=-15\text{dBm}$
 $V_{MIX}=V_{LO}=2.8\text{V}$

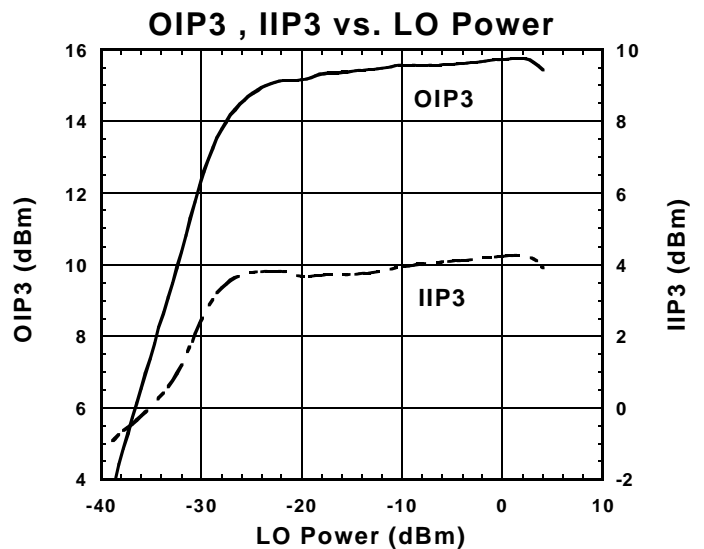

Condition
 $f_{IF}=134.85\text{MHz}$
 $f_{RF}=840.0+840.1\text{MHz}$,
 $P_{RF}=-30\text{dBm}$
 $f_{LO}=705.15\text{MHz}$
 $V_{MIX}=V_{LO}=2.8\text{V}$

■ TYPICAL CHARACTERISTICS 8(Mixer)

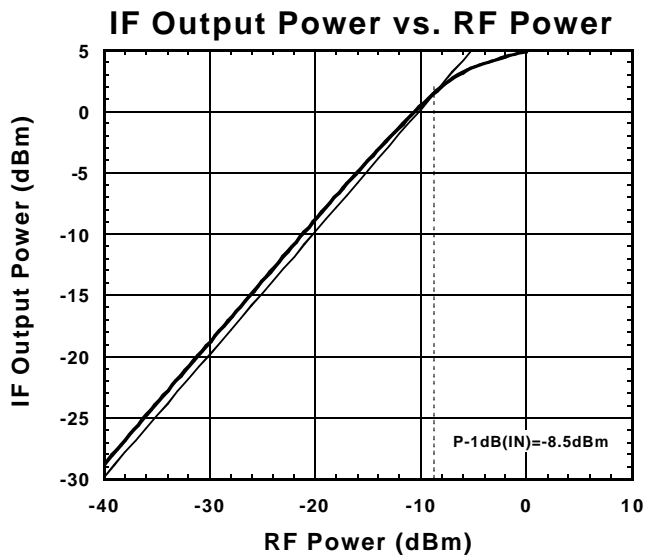

Condition
 $f_{IF}=134.85\text{MHz}$
 $f_{RF}=840\text{MHz}$
 $f_{LO}=705.15\text{MHz}, P_{LO}=-15\text{dBm}$
 $V_{MIX}=V_{LO}=2.8\text{V}$

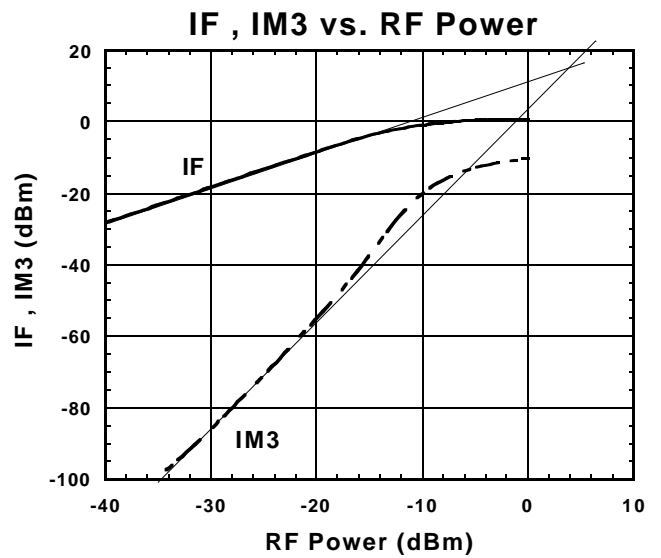

Condition
 $f_{IF}=134.85\text{MHz}$
 $f_{RF}=840.0+840.1\text{MHz}$
 $f_{LO}=705.15\text{MHz}, P_{LO}=-15\text{dBm}$
 $V_{MIX}=V_{LO}=2.8\text{V}$

LOCAL Leak Level vs. LO Frequency

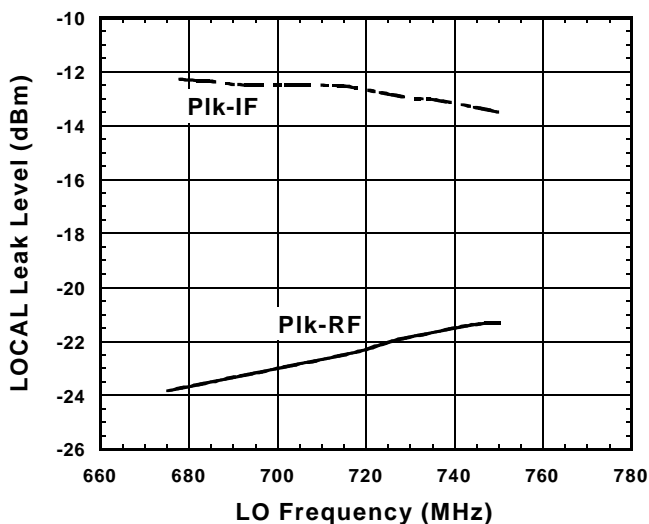

Condition
 $f_{LO}=675.15\sim 750.15\text{MHz}, P_{LO}=-15\text{dBm}$
 $V_{MIX}=V_{LO}=2.8\text{V}$

RF to LO ISOLATION vs. RF Frequency

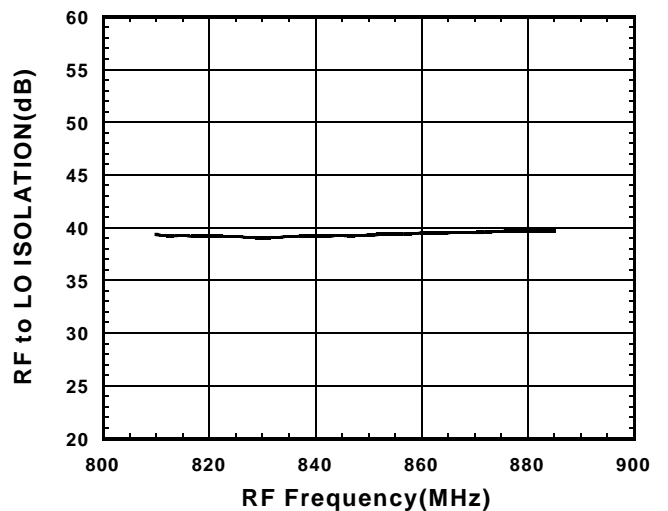

Condition
 $f_{RF}=810\sim 885\text{MHz}$
 $P_{RF}=0\text{dBm}$
 $V_{MIX}=V_{LO}=2.8\text{V}$

NJG1720PB1

■ TYPICAL CHARACTERISTICS 9(Mixer)

Gc, NF vs. Ambient Temperature

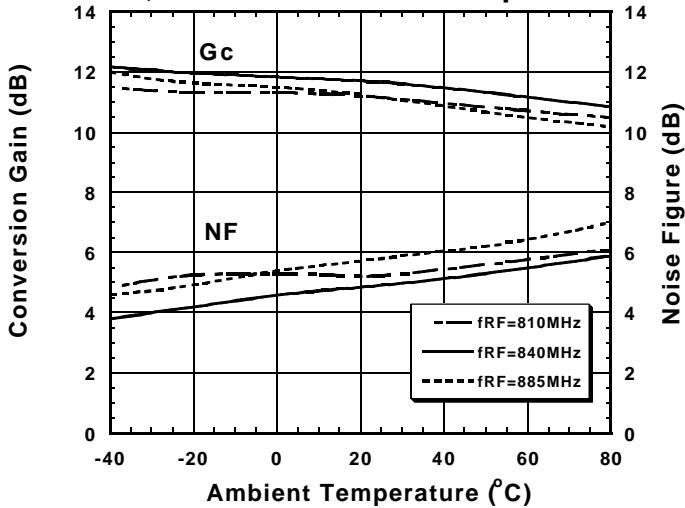

Condition
 $f_{IF}=134.85\text{MHz}$
 $f_{RF}=810\sim 85\text{MHz}$, $P_{RF}=-30\text{dBm}$
 $f_{LO}=675.15\sim 750.15\text{MHz}$, $P_{LO}=-15\text{dBm}$
 $V_{MIX}=V_{LO}=2.8\text{V}$

OIP3, IIP3 vs. Ambient Temperature

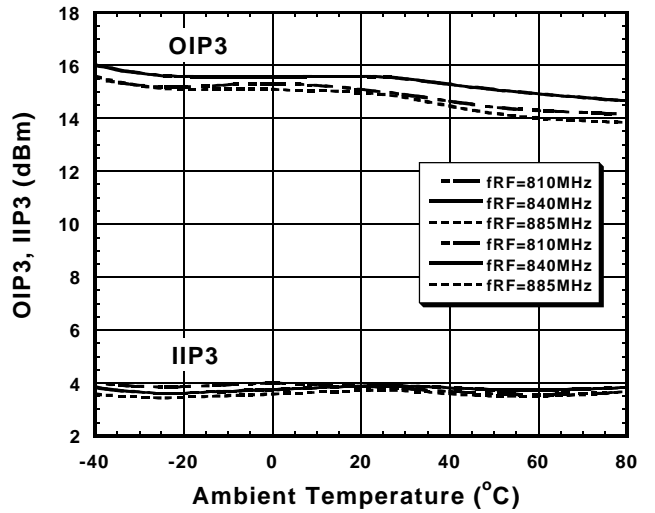

Condition
 $f_{IF}=134.85\text{MHz}$
 $f_{RF1}=810\sim 885\text{MHz}$
 $f_{RF2}=f_{RF1}+100\text{kHz}$, $P_{RF}=-30\text{dBm}$
 $f_{LO}=675.15\sim 750.15\text{MHz}$, $P_{LO}=-15\text{dBm}$
 $V_{MIX}=V_{LO}=2.8\text{V}$

P-1dB(IN) vs. Ambient Temperature

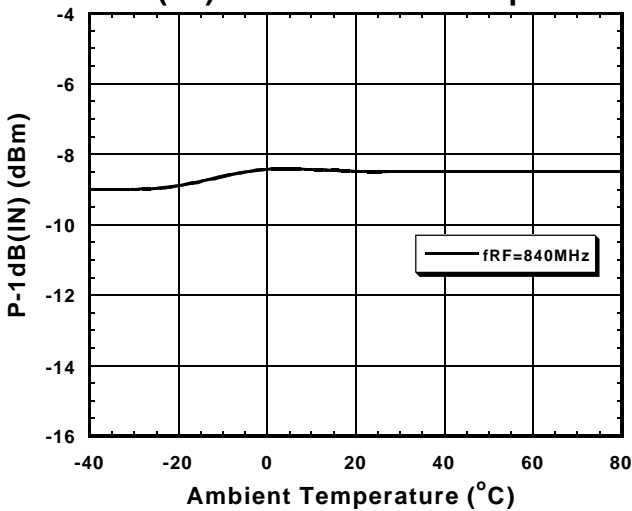

Condition
 $f_{IF}=134.85\text{MHz}$
 $f_{RF}=840\text{MHz}$
 $f_{LO}=705.15\text{MHz}$, $P_{LO}=-15\text{dBm}$
 $V_{MIX}=V_{LO}=2.8\text{V}$

■ TYPICAL CHARACTERISTICS 10(Mixer)

Conversion Gain vs. Frequency

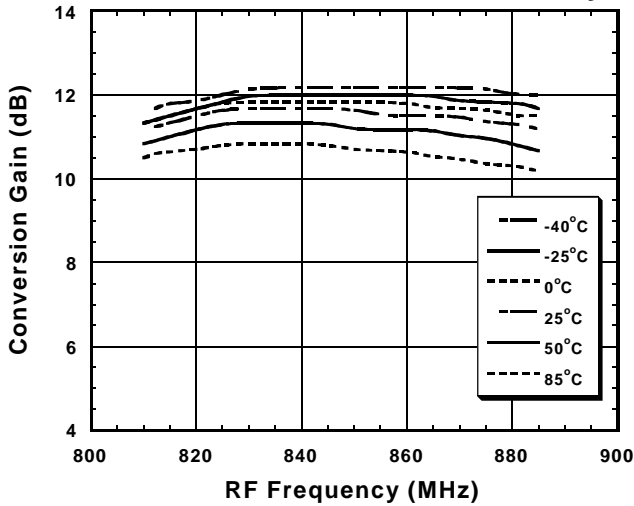

Condition

$f_{IF}=134.85\text{MHz}$
 $f_{RF}=810\sim 885\text{MHz}$, $P_{RF}=-30\text{dBm}$
 $f_{LO}=675.15\sim 750.15\text{MHz}$, $P_{LO}=-15\text{dBm}$
 $V_{MIX}=V_{LO}=2.8\text{V}$

Noise Figure vs. Frequency

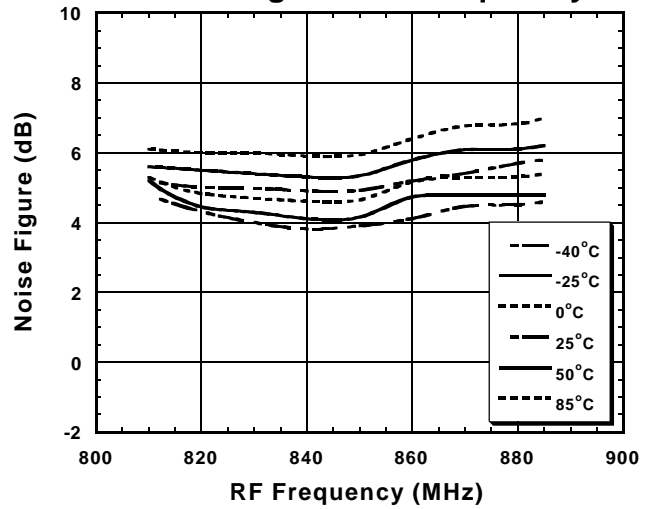

Condition

$f_{IF}=134.85\text{MHz}$
 $f_{RF}=810\sim 885\text{MHz}$, $P_{RF}=-30\text{dBm}$
 $f_{LO}=675.15\sim 750.15\text{MHz}$, $P_{LO}=-15\text{dBm}$
 $V_{MIX}=V_{LO}=2.8\text{V}$

OIP3 vs. Frequency

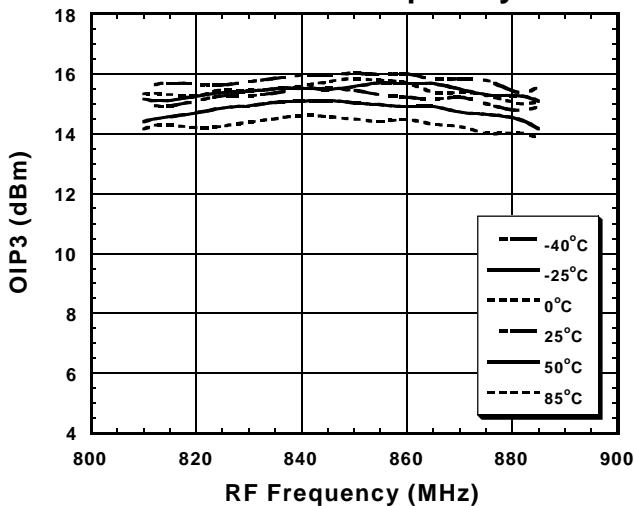

Condition

$f_{IF}=134.85\text{MHz}$
 $f_{RF1}=810\sim 885\text{MHz}$
 $f_{RF2}=f_{RF1}+100\text{kHz}$, $P_{RF}=-30\text{dBm}$
 $f_{LO}=675.15\sim 750.15\text{MHz}$, $P_{LO}=-15\text{dBm}$
 $V_{MIX}=V_{LO}=2.8\text{V}$

IIP3 vs. Frequency

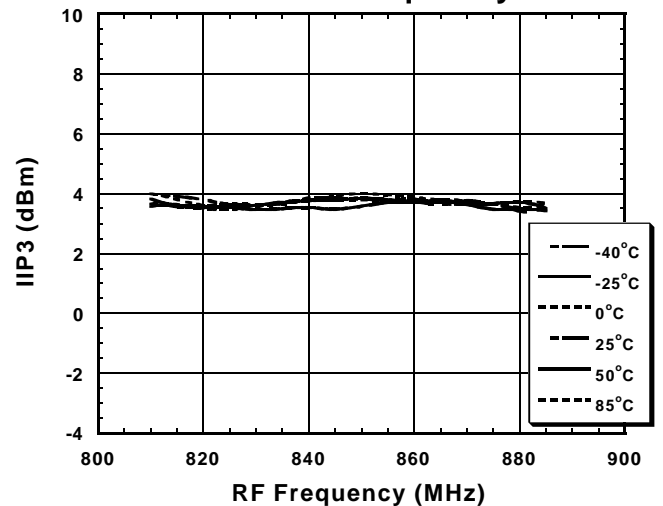

Condition

$f_{IF}=134.85\text{MHz}$
 $f_{RF1}=810\sim 885\text{MHz}$
 $f_{RF2}=f_{RF1}+100\text{kHz}$, $P_{RF}=-30\text{dBm}$
 $f_{LO}=675.15\sim 750.15\text{MHz}$, $P_{LO}=-15\text{dBm}$
 $V_{MIX}=V_{LO}=2.8\text{V}$

NJG1720PB1

■ TYPICAL CHARACTERISTICS 11(Mixer)

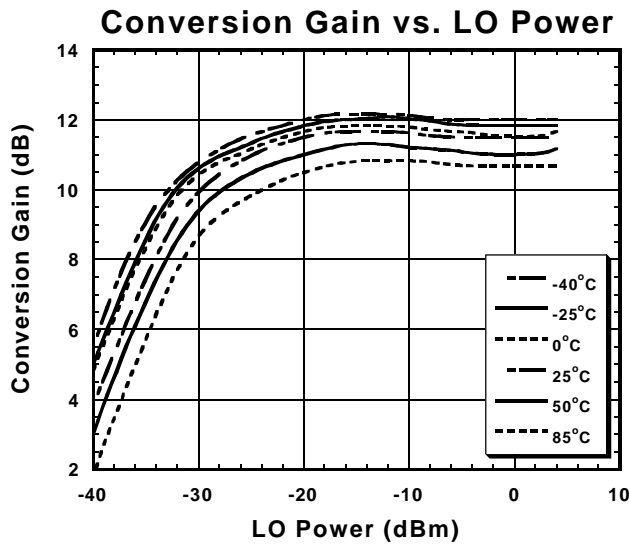

Condition
 $f_{IF}=134.85\text{MHz}$
 $f_{RF}=840\text{MHz}$, $P_{RF}=-30\text{dBm}$
 $f_{LO}=705.15\text{MHz}$
 $V_{MIX}=V_{LO}=2.8\text{V}$

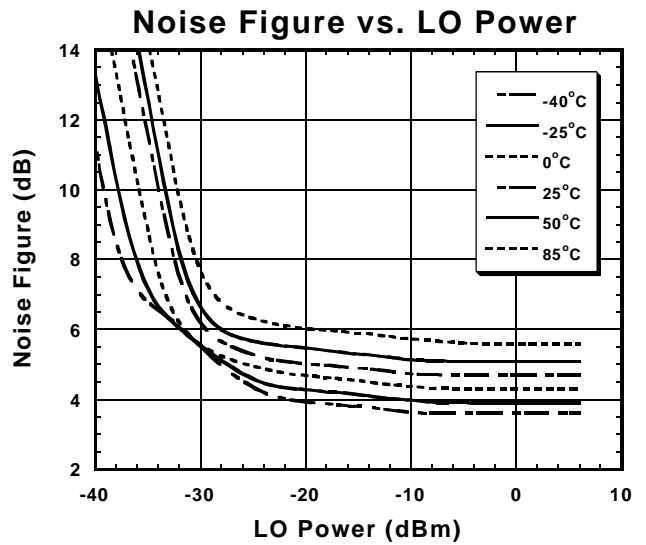

Condition
 $f_{IF}=134.85\text{MHz}$
 $f_{RF}=840\text{MHz}$, $P_{RF}=-30\text{dBm}$
 $f_{LO}=705.15\text{MHz}$
 $V_{MIX}=V_{LO}=2.8\text{V}$

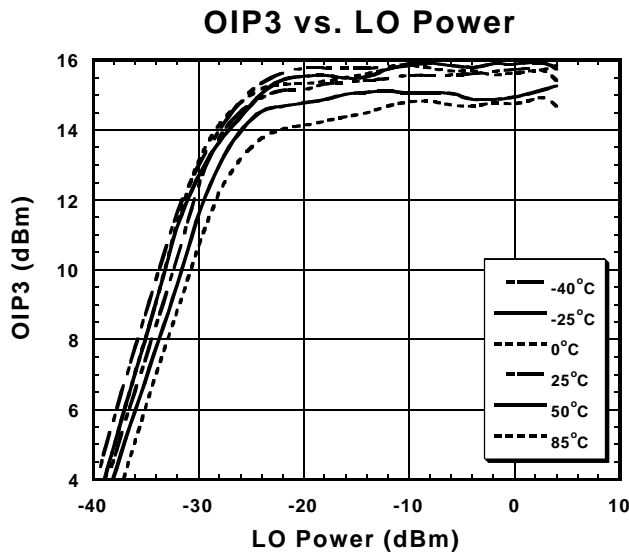

Condition
 $f_{IF}=134.85\text{MHz}$
 $f_{RF}=840.0+840.1\text{MHz}$,
 $P_{RF}=-30\text{dBm}$
 $f_{LO}=705.15\text{MHz}$
 $V_{MIX}=V_{LO}=2.8\text{V}$

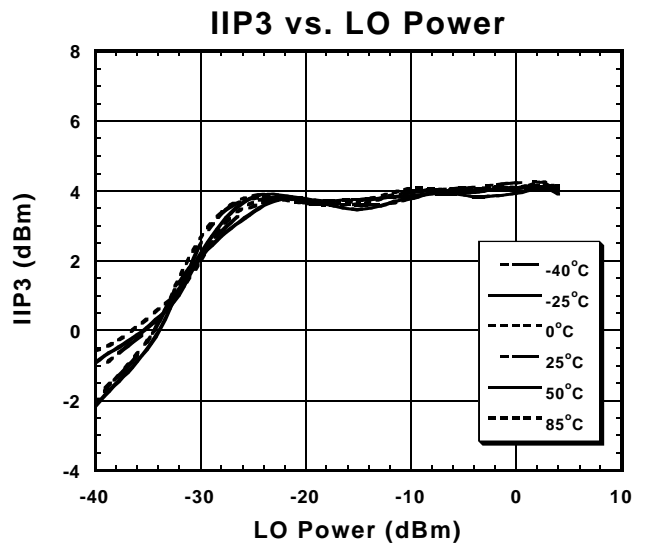

Condition
 $f_{IF}=134.85\text{MHz}$
 $f_{RF}=840.0+840.1\text{MHz}$,
 $P_{RF}=-30\text{dBm}$
 $f_{LO}=705.15\text{MHz}$
 $V_{MIX}=V_{LO}=2.8\text{V}$

■ TYPICAL CHARACTERISTICS 12(Mixer)

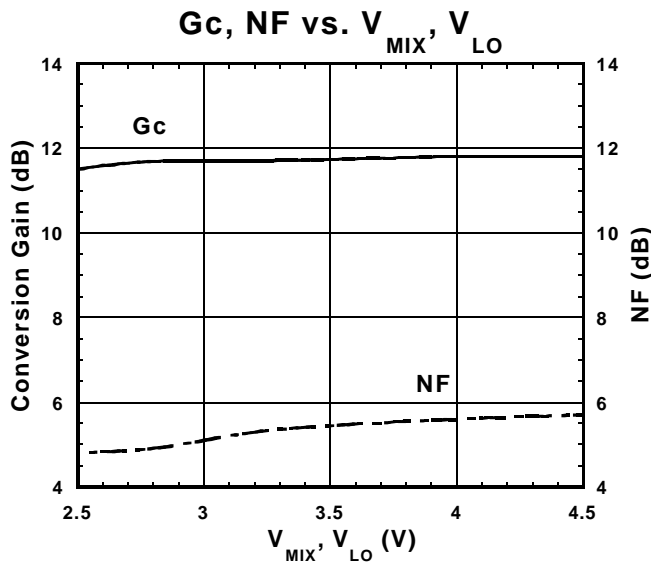

Condition
 $f_{IF}=134.85\text{MHz}$
 $f_{RF}=840\text{MHz}$, $P_{RF}=-30\text{dBm}$
 $f_{LO}=705.15\text{MHz}$, $P_{LO}=-15\text{dBm}$

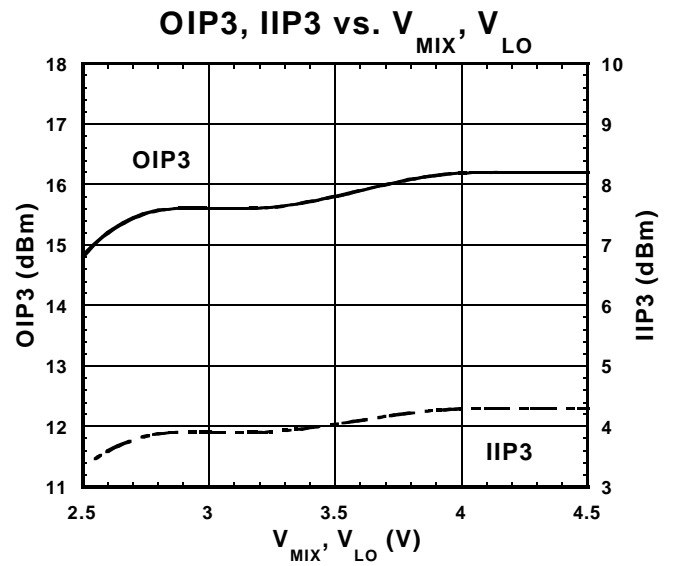

Condition
 $f_{IF}=134.85\text{MHz}$
 $f_{RF}=840.0+840.1\text{MHz}$,
 $P_{RF}=-30\text{dBm}$
 $f_{LO}=705.15\text{MHz}$, $P_{LO}=-15\text{dBm}$

NJG1720PB1

■TYPICAL CHARACTERISTICS 13(Mixer)

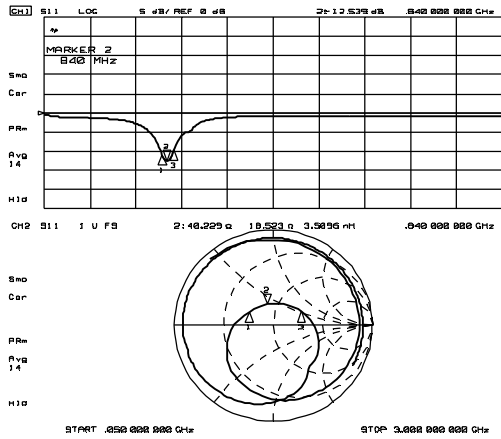

MIXER IN Port Impedance
 ($P_{LO}=-15\text{dBm}$, IF OUT Port: 50ohm term.)

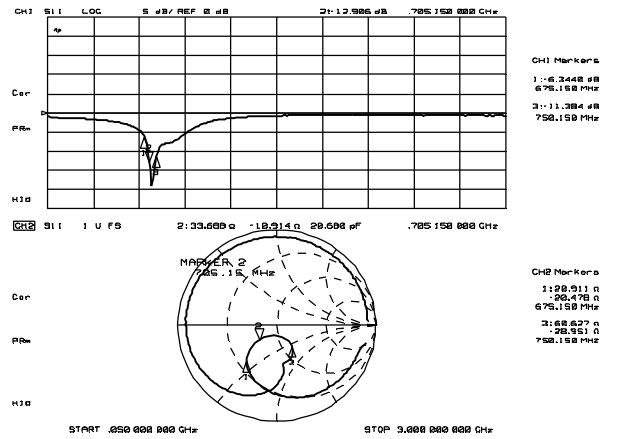

LOCAL IN Port Impedance
 (MIXER IN Port, IF OUT Port: 50 ohm term.)

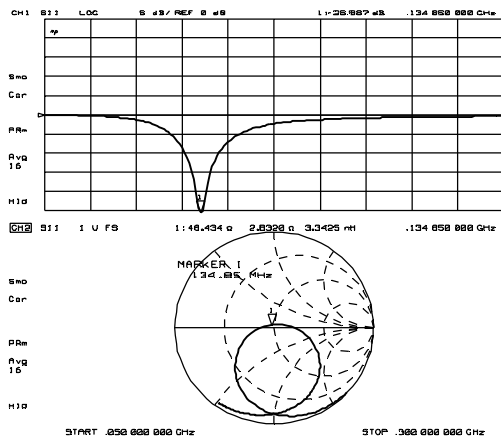

IF OUT Port Impedance
 ($P_{LO}=-15\text{dBm}$, MIXER IN Port: 50ohm term.)

TEST CIRCUIT

(Top View)

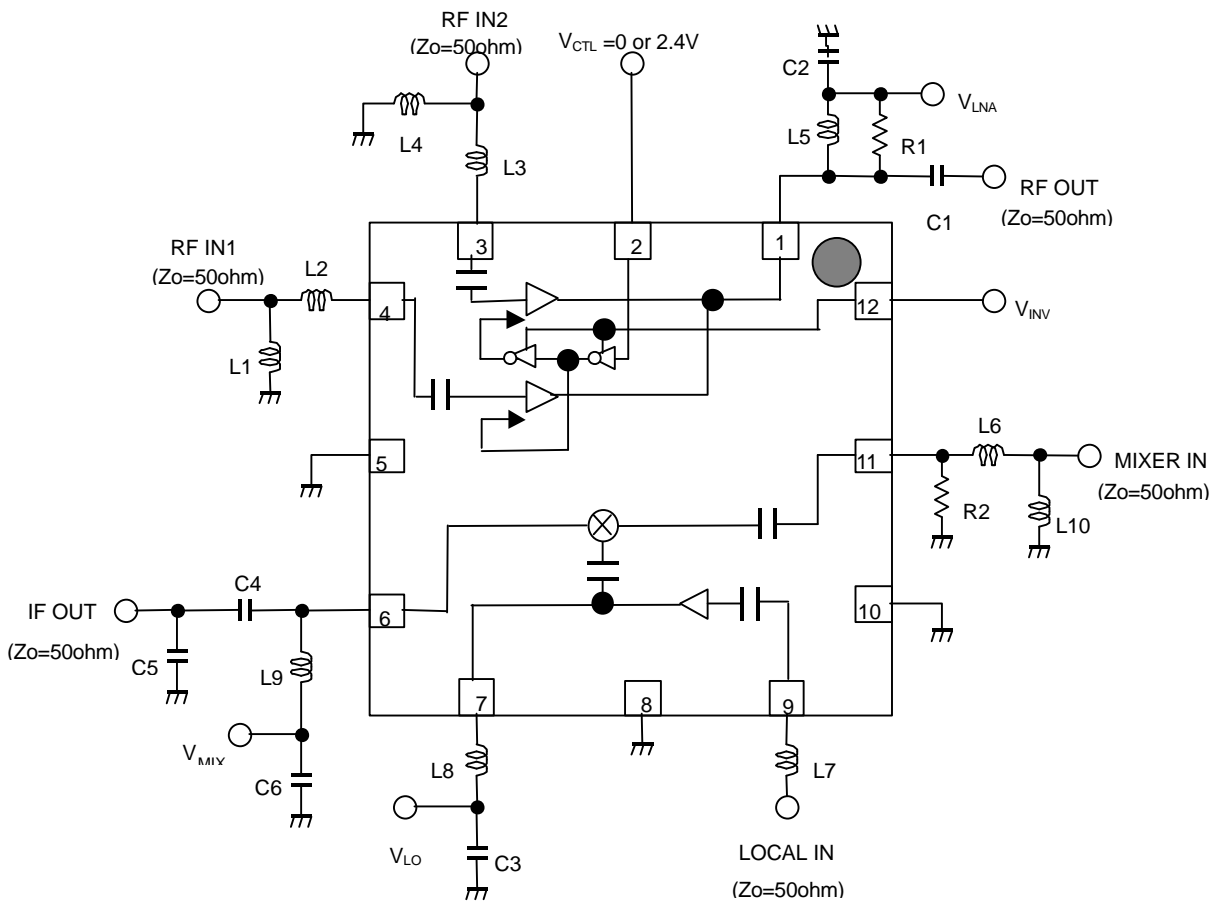

PARTS LIST

Parts ID	Value	COMMENT
L1	22nH	TAIYO-YUDEN(HK1005,1005size)
L2	33nH	PANASONIC[MEC](ELJRE,1608size)
L3	27nH	TAIYO-YUDEN(HK1608,1608size)
L4	18nH	TAIYO-YUDEN(HK1005,1005size)
L5	8.2nH	TAIYO-YUDEN(HK1005,1005size)
L6	39nH	PANASONIC[MEC](ELJRF,1005size)
L7	47nH	PANASONIC[MEC](ELJRF,1005size)
L8	47nH	PANASONIC[MEC](ELJRF,1005size)
L9	150nH	TAIYO-YUDEN(HK1608,1608size)
L10	56nH	TAIYO-YUDEN(HK1005,1005size)
C1	2pF	MURATA(GRM36,1005size)
C2	0.01uF	MURATA(GRM36,1005size)
C3	0.01uF	MURATA(GRM36,1005size)
C4	9pF	MURATA(GRM36,1005size)
C5	12pF	MURATA(GRM36,1005size)
C6	0.01uF	MURATA(GRM36,1005size)
R1	1.5kΩ	1005size
R2	4.7kΩ	1005size

NJG1720PB1

RECOMMENDED PCB DESIGN

(Top View)

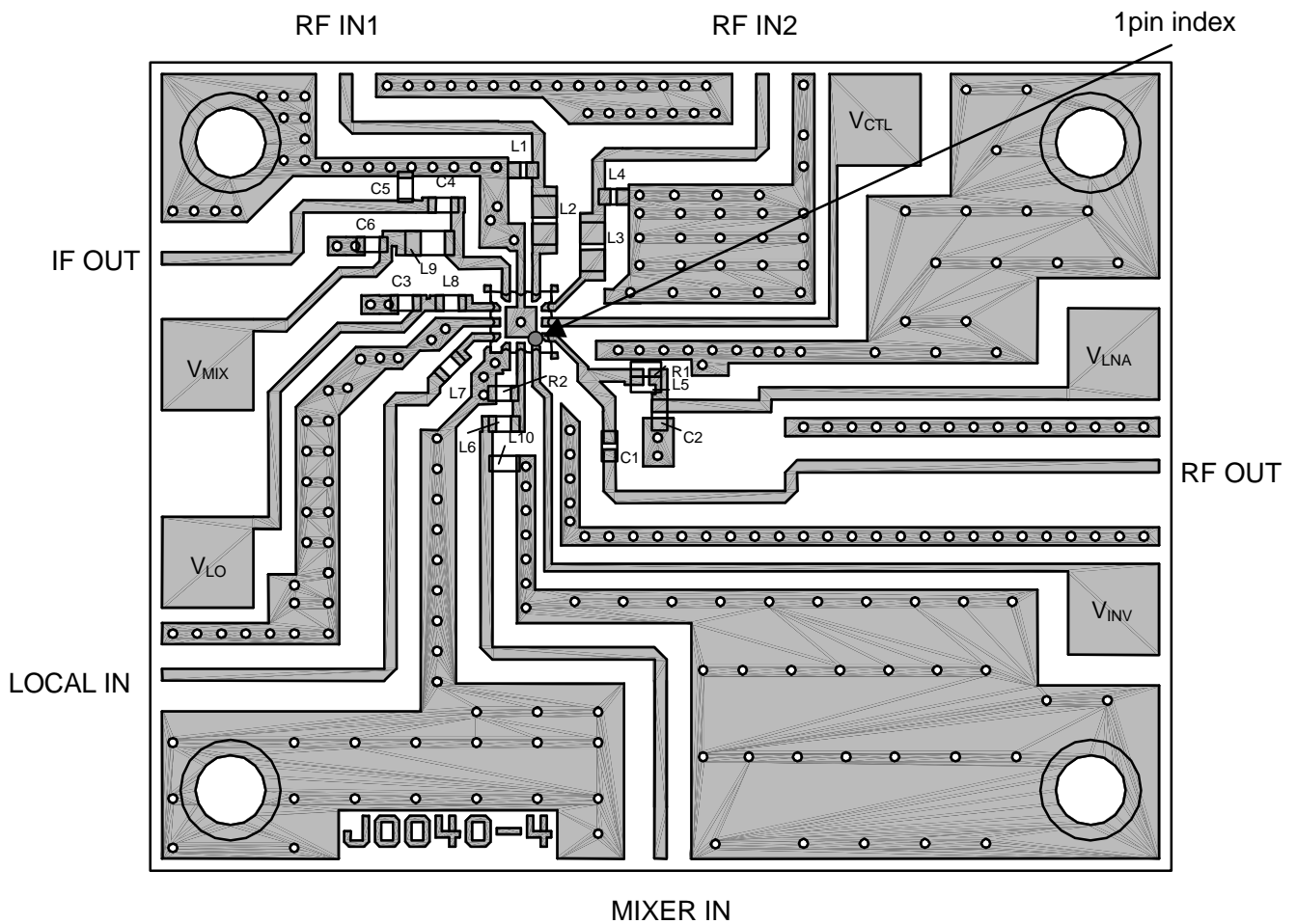

PCB(FR-4), t=0.2mm

MICROSTRIP LINE WIDTH=0.4mm ($Z_0=50\text{ohm}$)

PRECAUTION

1. Please locate L5 close to C2.
2. Please locate L8 close to VLO terminal(7).
3. Please locate L8 close to C3.
4. Please locate L9 close to C6.

PACKAGE OUTLINE (FFP12-B1)

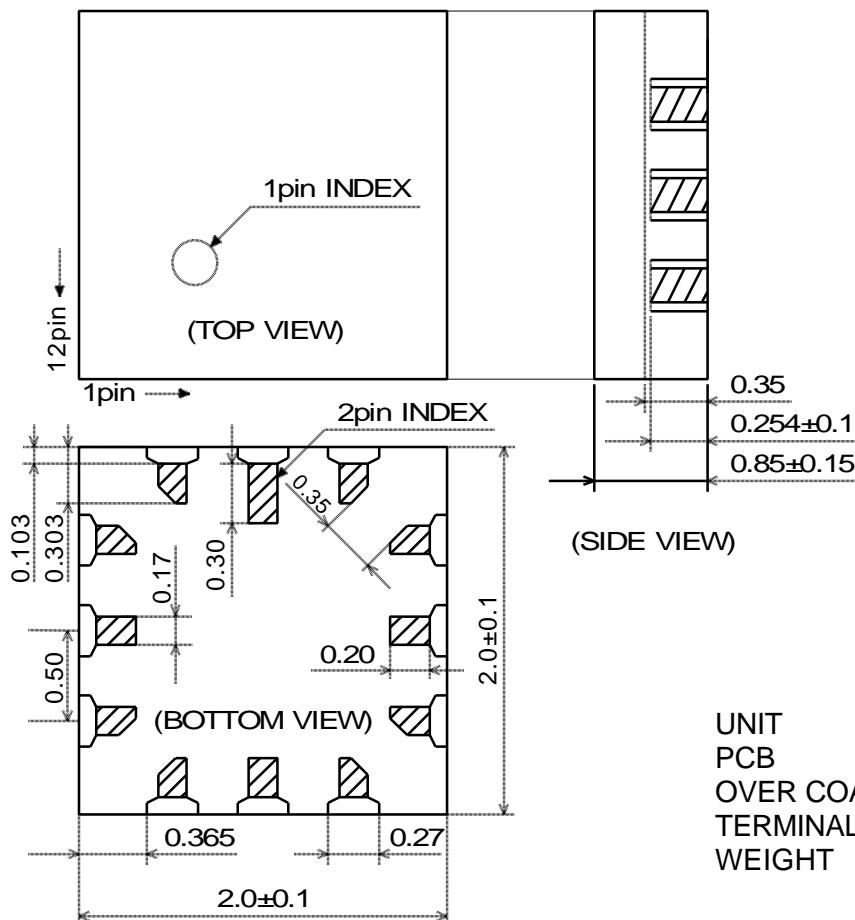

UNIT	: mm
PCB	: Ceramic
OVER COAT	: Epoxy resin
TERMINAL TREAT	: Au
WEIGHT	: 10mg

Cautions on using this product

This product contains Gallium-Arsenide (GaAs) which is a harmful material.

- Do NOT eat or put into mouth.
- Do NOT dispose in fire or break up this product.
- Do NOT chemically make gas or powder with this product.
- To waste this product, please obey the relating law of your country.

[CAUTION]

The specifications on this databook are only given for information, without any guarantee as regards either mistakes or omissions. The application circuits in this databook are described only to show representative usages of the product and not intended for the guarantee or permission of any right including the industrial rights.

This product may be damaged with electric static discharge (ESD) or spike voltage. Please handle with care to avoid these damages.