

MegaMOS™ Power MOSFET

IRFP 460

$$V_{DSS} = 500 \text{ V}$$

$$I_{D(\text{cont})} = 20 \text{ A}$$

$$R_{DS(\text{on})} = 0.27 \Omega$$

N-Channel Enhancement Mode, HDMOS™ Family

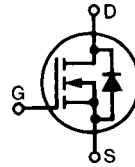

Symbol	Test Conditions	Maximum Ratings	
V_{DSS}	$T_J = 25^\circ\text{C}$ to 150°C	500	V
V_{DGR}	$T_J = 25^\circ\text{C}$ to 150°C ; $R_{GS} = 1 \text{ M}\Omega$	500	V
V_{GS}	Continuous	± 20	V
V_{GSM}	Transient	± 30	V
I_{D25}	$T_C = 25^\circ\text{C}$	20	A
I_{DM}	$T_C = 25^\circ\text{C}$, pulse width limited by T_{JM}	80	A
I_{AR}		20	A
E_{AR}	$T_C = 25^\circ\text{C}$	28	mJ
dv/dt	$I_S \leq I_{DM}$, $di/dt \leq 100 \text{ A}/\mu\text{s}$, $V_{DD} \leq V_{DSS}$, $T_J \leq 150^\circ\text{C}$, $R_G = 2 \Omega$	3.5	V/ns
P_D	$T_C = 25^\circ\text{C}$	260	W
T_J		-55 ... +150	$^\circ\text{C}$
T_{JM}		150	$^\circ\text{C}$
T_{stg}		-55 ... +150	$^\circ\text{C}$
M_d	Mounting torque	1.15/10	Nm/lb.in.
Weight		6	g
Maximum lead temperature for soldering 1.6 mm (0.062 in.) from case for 10 s		300	$^\circ\text{C}$

TO-247 AD

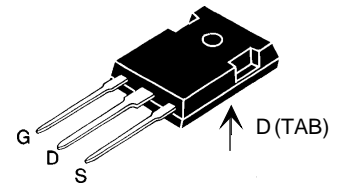

G = Gate,
S = Source,
D = Drain,
TAB = Drain

Features

- Repetitive avalanche energy rated
- Fast switching times
- Low $R_{DS(\text{on})}$ HDMOS™ process
- Rugged polysilicon gate cell structure
- High Commutating dv/dt Rating

Applications

- Switching Power Supplies
- Motor controls

Symbol	Test Conditions	Characteristic Values ($T_J = 25^\circ\text{C}$, unless otherwise specified)		
		min.	typ.	max.
V_{DSS}	$V_{GS} = 0 \text{ V}$, $I_D = 250 \mu\text{A}$	500		V
$V_{GS(\text{th})}$	$V_{DS} = V_{GS}$, $I_D = 250 \mu\text{A}$	2		V
I_{GSS}	$V_{GS} = \pm 20 \text{ V}_{DC}$, $V_{DS} = 0$			$\pm 100 \text{ nA}$
I_{DSS}	$V_{DS} = 0.8 \cdot V_{DSS}$, $T_J = 25^\circ\text{C}$ $V_{GS} = 0 \text{ V}$, $T_J = 125^\circ\text{C}$			25 μA 250 μA
$R_{DS(\text{on})}$	$V_{GS} = 10 \text{ V}$, $I_D = 12 \text{ A}$ Pulse test, $t \leq 300 \mu\text{s}$, duty cycle $d \leq 2 \%$	0.25	0.27	Ω

Symbol	Test Conditions	Characteristic Values ($T_J = 25^\circ\text{C}$, unless otherwise specified)			
		min.	typ.	max.	
g_{fs}	$V_{DS} = 10\text{ V}; I_D = 12\text{ A}$, pulse test	13	21	S	
C_{iss}	$V_{GS} = 0\text{ V}, V_{DS} = 25\text{ V}, f = 1\text{ MHz}$		4200	pF	
C_{oss}			450	pF	
C_{rss}			135	pF	
$t_{d(on)}$	$V_{GS} = 10\text{ V}, V_{DS} = 250\text{ V}, I_D = 20\text{ A}$ $R_G = 4.3\ \Omega$, (External)		23	35	ns
t_r			81	120	ns
$t_{d(off)}$			85	130	ns
t_f			65	98	ns
$Q_{g(on)}$	$V_{GS} = 10\text{ V}, V_{DS} = 200\text{ V}, I_D = 20\text{ A}$		135	210	nC
Q_{gs}			28	40	nC
Q_{gd}			62	110	nC
R_{thJC}			0.45	K/W	
R_{thCK}		0.25		K/W	

Source-Drain Diode

Symbol	Test Conditions	Characteristic Values ($T_J = 25^\circ\text{C}$, unless otherwise specified)		
		min.	typ.	max.
I_S	$V_{GS} = 0\text{ V}$			20 A
I_{SM}	Repetitive; pulse width limited by T_{JM}			80 A
V_{SD}	$I_F = 20\text{ A}, V_{GS} = 0\text{ V}$, Pulse test, $t \leq 300\ \mu\text{s}$, duty cycle $d \leq 2\%$			1.8 V
t_{rr}	$I_F = 20\text{ A}, -di/dt = 100\text{ A}/\mu\text{s}, V_R = 100\text{ V}$		570	860 ns
Q_{rr}			5.7	μC

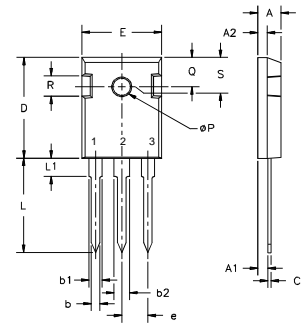
TO-247 AD Outline

Terminals: 1 - Gate 2 - Drain
3 - Source Tab - Drain

Dim.	Millimeter		Inches	
	Min.	Max.	Min.	Max.
A	4.7	5.3	.185	.209
A ₁	2.2	2.54	.087	.102
A ₂	2.2	2.6	.059	.098
b	1.0	1.4	.040	.055
b ₁	1.65	2.13	.065	.084
b ₂	2.87	3.12	.113	.123
C	.4	.8	.016	.031
D	20.80	21.46	.819	.845
E	15.75	16.26	.610	.640
e	5.20	5.72	0.205	0.225
L	19.81	20.32	.780	.800
L1		4.50		.177
∅P	3.55	3.65	.140	.144
Q	5.89	6.40	0.232	0.252
R	4.32	5.49	.170	.216
S	6.15	BSC	242	BSC

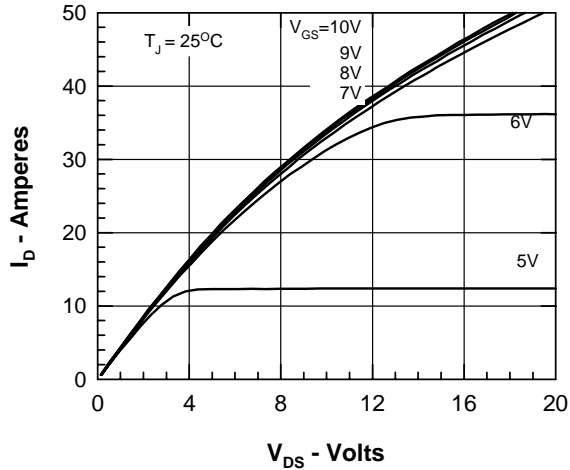

Figure 1. Output Characteristics at 25°C

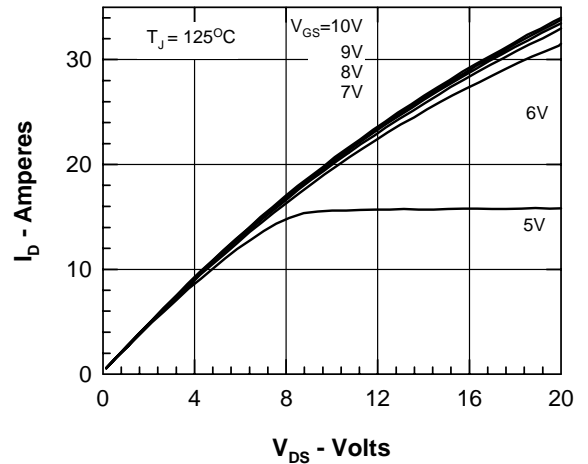

Figure 2. Output Characteristics at 125°C

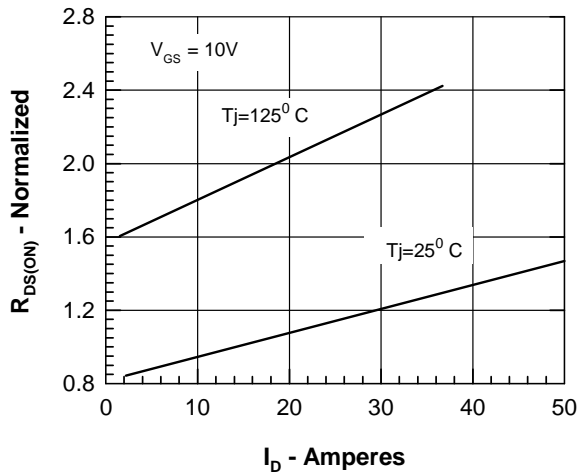

Figure 3. $R_{DS(on)}$ normalized to value at $I_D = 12A$

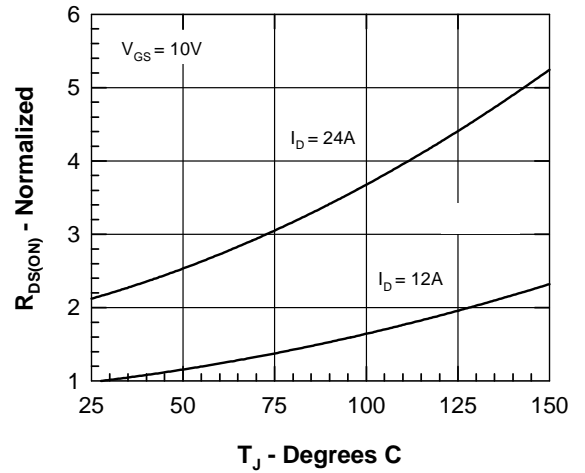

Figure 4. $R_{DS(on)}$ normalized to value at $I_D = 12A$

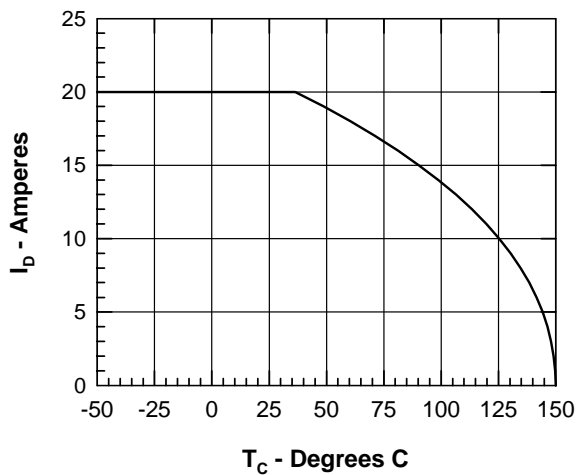

Figure 5. Drain Current vs. Case Temperature

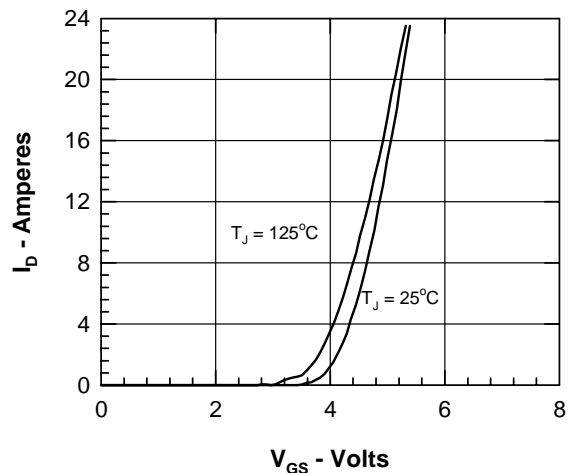

Figure 6. Admittance Curves

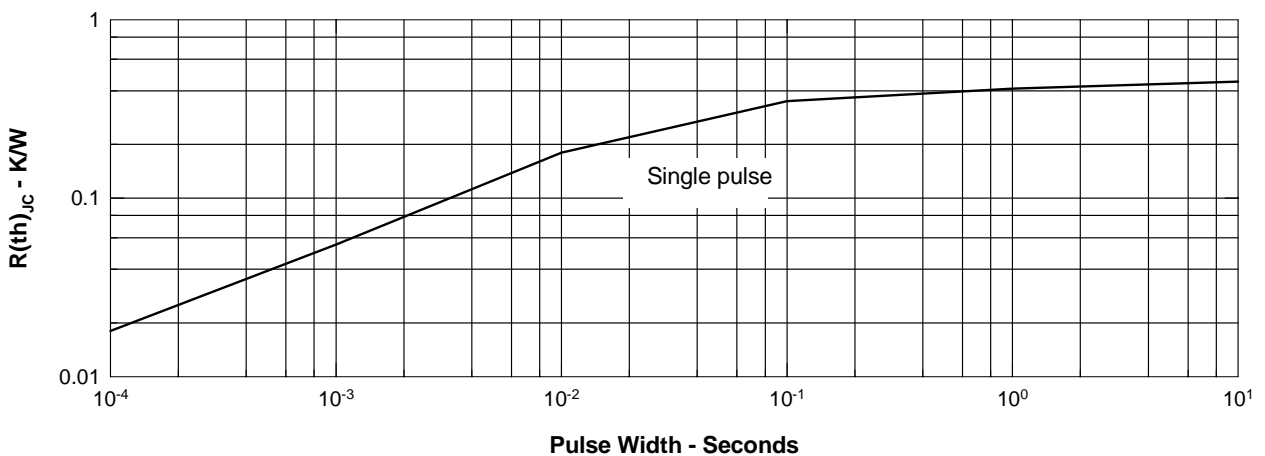
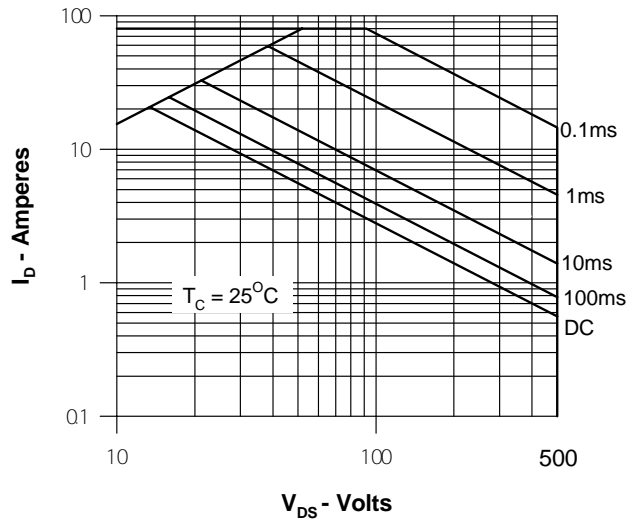
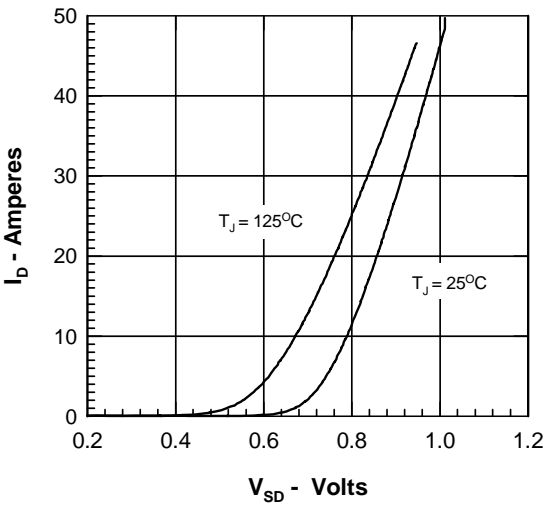
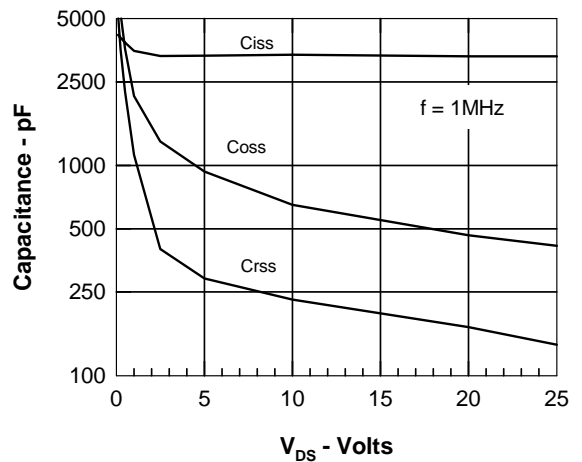
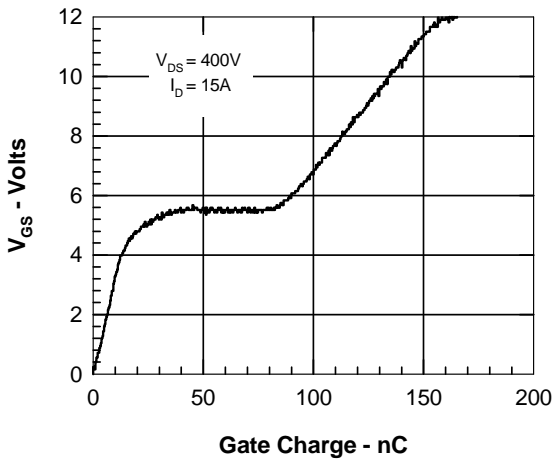

Figure 11. Transient Thermal Resistance