

High-Voltage — High Power Transistors

... designed for use in high power audio amplifier applications and high voltage switching regulator circuits.

- High Collector Emitter Sustaining Voltage —
 $V_{CEO(sus)} = 120 \text{ Vdc}$ — 2N5630, 2N6030
 $= 140 \text{ Vdc}$ — 2N5631, 2N6031
- High DC Current Gain — @ $I_C = 8.0 \text{ Adc}$
 $h_{FE} = 20 \text{ (Min)}$ — 2N5630, 2N6030
 $= 15 \text{ (Min)}$ — 2N5631, 2N6031
- Low Collector–Emitter Saturation Voltage —
 $V_{CE(sat)} = 1.0 \text{ Vdc (Max)}$ @ $I_C = 10 \text{ Adc}$

MAXIMUM RATINGS (1)

Rating	Symbol	2N5630 2N6030	2N5631 2N6031	Unit
Collector–Emitter Voltage	V_{CEO}	120	140	Vdc
Collector–Base Voltage	V_{CB}	120	140	Vdc
Emitter–Base Voltage	V_{EB}	7.0		Vdc
Collector Current — Continuous Peak	I_C	16 20		A dc
Base Current — Continuous	I_B	5.0		A dc
Total Device Dissipation @ $T_C = 25^\circ\text{C}$ Derate above 25°C	P_D	200 1.14		Watts W/ $^\circ\text{C}$
Operating and Storage Junction Temperature Range	T_J, T_{stg}	–65 to +200		$^\circ\text{C}$

THERMAL CHARACTERISTICS (1)

Characteristic	Symbol	Max	Unit
Thermal Resistance, Junction to Case	θ_{JC}	0.875	$^\circ\text{C/W}$

(1) Indicates JEDEC Registered Data.

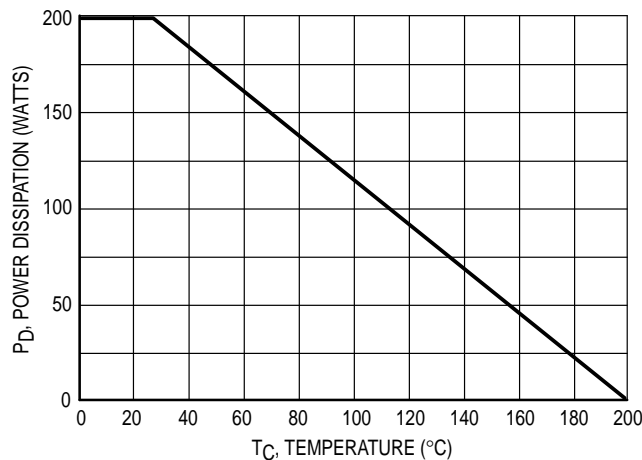

Figure 1. Power Derating

Safe Area Curves are indicated by Figure 5. All Limits are applicable and must be observed.

NPN
2N5630

2N5631
PNP
2N6030

2N6031

16 AMPERE
POWER TRANSISTORS
COMPLEMENTARY
SILICON
100–120–140 VOLTS
200 WATTS

CASE 1-07
TO-204AA
(TO-3)

2N5630 2N5631 2N6030 2N6031

ELECTRICAL CHARACTERISTICS (T_C = 25°C unless otherwise noted)

Characteristic	Symbol	Min	Max	Unit
OFF CHARACTERISTICS				
Collector–Emitter Sustaining Voltage (1) (I _C = 200 mA _{dc} , I _B = 0)	V _{CEO(sus)}	120 140	—	V _{dc}
Collector–Emitter Cutoff Current (V _{CE} = 50 V _{dc} , I _B = 0) (V _{CE} = 60 V _{dc} , I _B = 0) (V _{CE} = 70 V _{dc} , I _B = 0)	I _{CEO}	— —	2.0 2.0	mA _{dc}
Collector–Emitter Cutoff Current (V _{CE} = Rated V _{CB} , V _{EB(off)} = 1.5 V _{dc}) (V _{CE} = Rated V _{CB} , V _{EB(off)} = 1.5 V _{dc} , T _C = 150°C)	I _{CEX}	— —	2.0 7.0	mA _{dc}
Collector–Base Cutoff Current (V _{CB} = Rated V _{CB} , I _E = 0)	I _{CBO}	—	2.0	mA _{dc}
Emitter–Base Cutoff Current (V _{BE} = 7.0 V _{dc} , I _C = 0)	I _{EBO}	—	5.0	mA _{dc}

ON CHARACTERISTICS (1)

DC Current Gain (I _C = 8.0 A _{dc} , V _{CE} = 2.0 V _{dc}) (I _C = 16 A _{dc} , V _{CE} = 2.0 V _{dc})	h _{FE}	20 15 4.0	80 60 —	—
Collector–Emitter Saturation Voltage (I _C = 10 A _{dc} , I _B = 1.0 A _{dc}) (I _C = 16 A _{dc} , I _B = 4.0 A _{dc})	V _{CE(sat)}	— —	1.0 2.0	V _{dc}
Base–Emitter Saturation Voltage (I _C = 10 A _{dc} , I _B = 1.0 A _{dc})	V _{BE(sat)}	—	1.8	V _{dc}
Base–Emitter On Voltage (I _C = 8.0 A _{dc} , V _{CE} = 2.0 V _{dc})	V _{BE(on)}	—	1.5	V _{dc}

DYNAMIC CHARACTERISTICS

Current–Gain — Bandwidth Product (2) (I _C = 1.0 A _{dc} , V _{CE} = 20 V _{dc} , f _{test} = 0.5 MHz)	f _T	1.0	—	MHz
Output Capacitance (V _{CB} = 10 V _{dc} , I _E = 0, f = 0.1 MHz)	C _{ob}	— —	500 1000	pF
Small–Signal Current Gain (I _C = 4.0 A _{dc} , V _{CE} = 10 V _{dc} , f = 1.0 kHz)	h _{fe}	15	—	—

* Indicates JEDEC Registered Data.

(1) Pulse Test: Pulse Width ≤ 300 μs, Duty Cycle ≥ 2.0%.

(2) f_T = |h_{fe}| • f_{test}

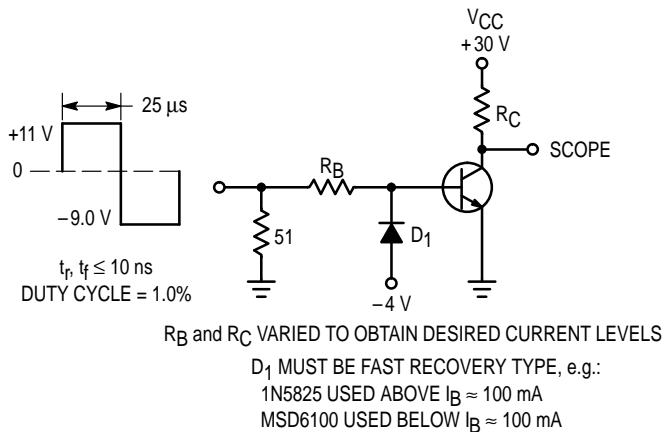

For PNP test circuit, reverse all polarities and D1.

Figure 2. Switching Times Test Circuit

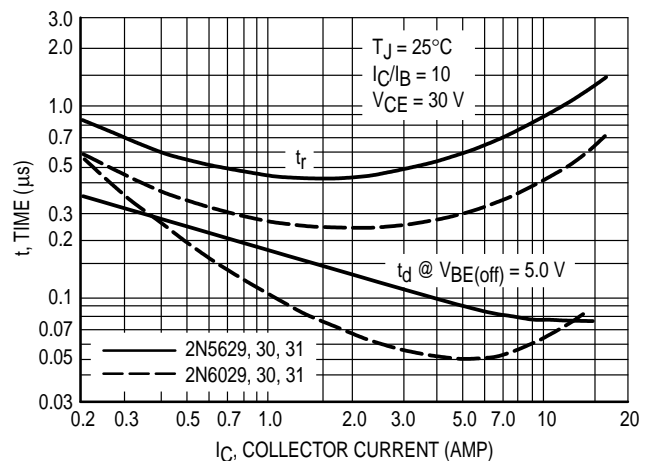

Figure 3. Turn–On Time

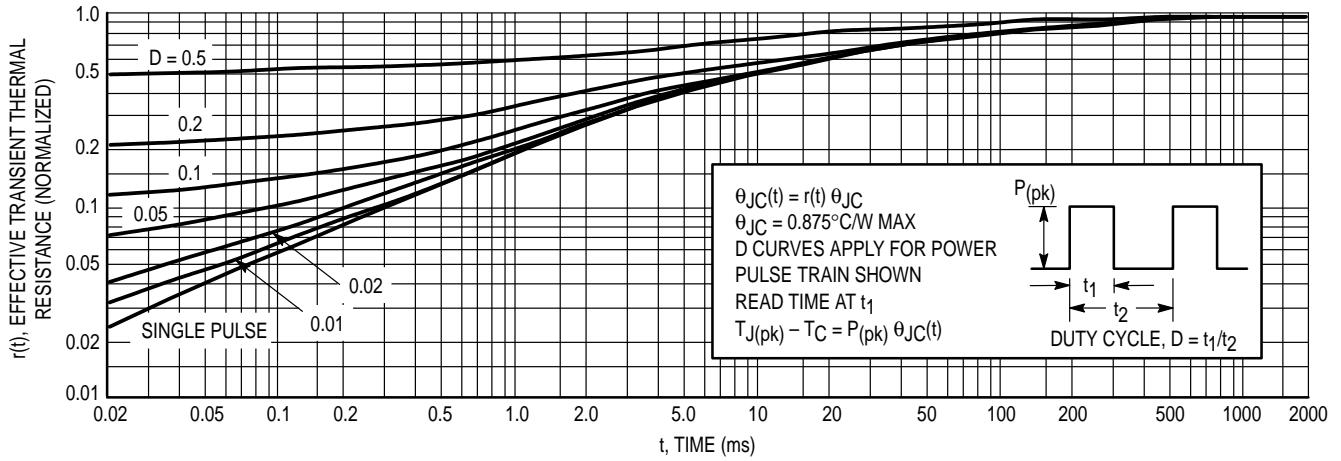

Figure 4. Thermal Response

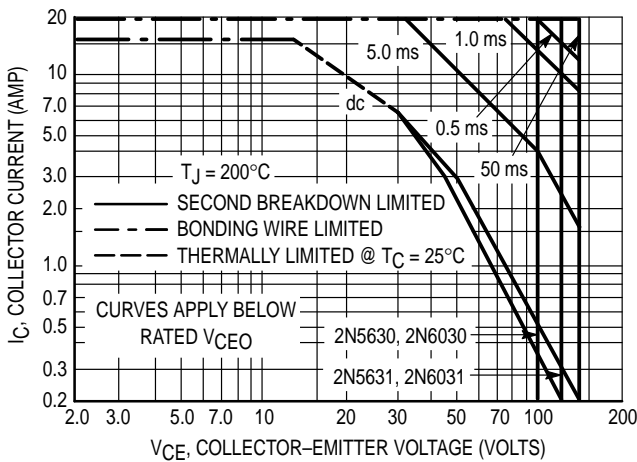

Figure 5. Active-Region Safe Operating Area

There are two limitations on the power handling ability of a transistor: average junction temperature and second breakdown. Safe operating area curves indicate $I_C - V_{CE}$ limits of the transistor that must be observed for reliable operation, i.e., the transistor must not be subjected to greater dissipation than the curves indicate.

The data of Figure 5 is based on $T_{J(pk)} = 200^\circ\text{C}$; T_C is variable depending on conditions. Second breakdown pulse limits are valid for duty cycles to 10% provided $T_{J(pk)} \leq 200^\circ\text{C}$. $T_{J(pk)}$ may be calculated from the data in Figure 4. At high case temperatures, thermal limitations will reduce the power that can be handled to values less than the limitations imposed by second breakdown.

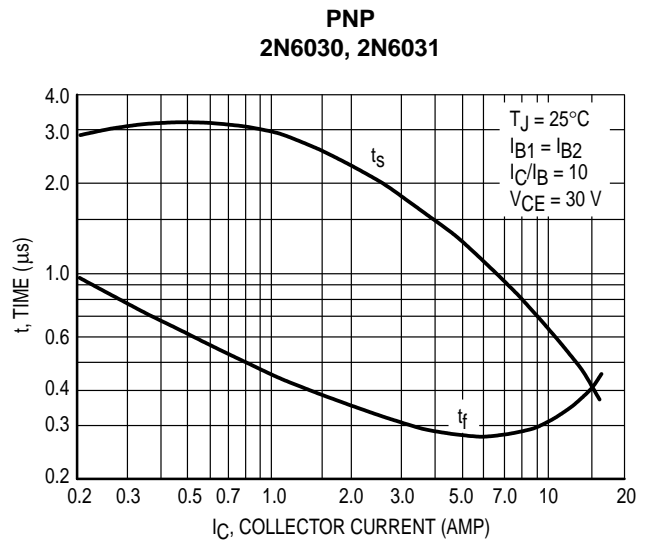
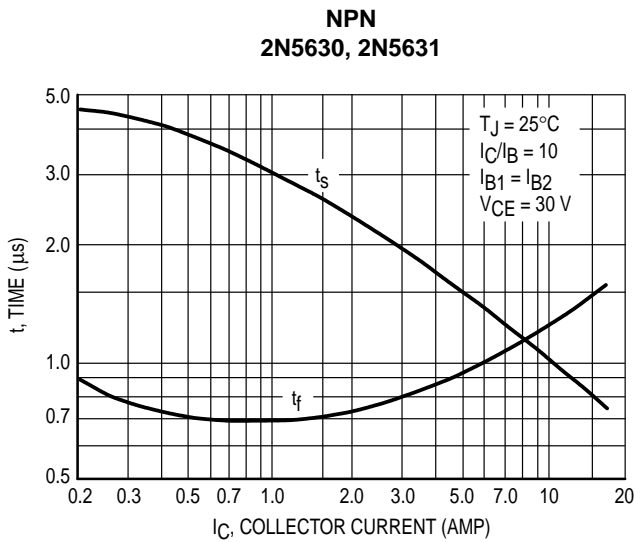

Figure 6. Turn-Off Time

2N5630 2N5631 2N6030 2N6031

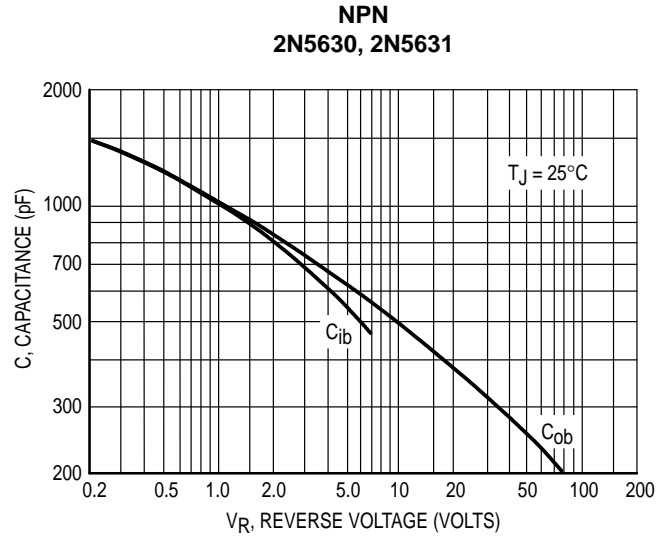
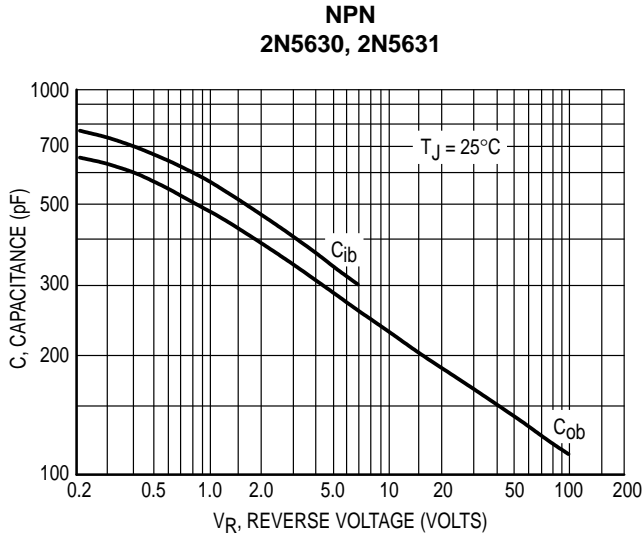

Figure 7. Capacitance

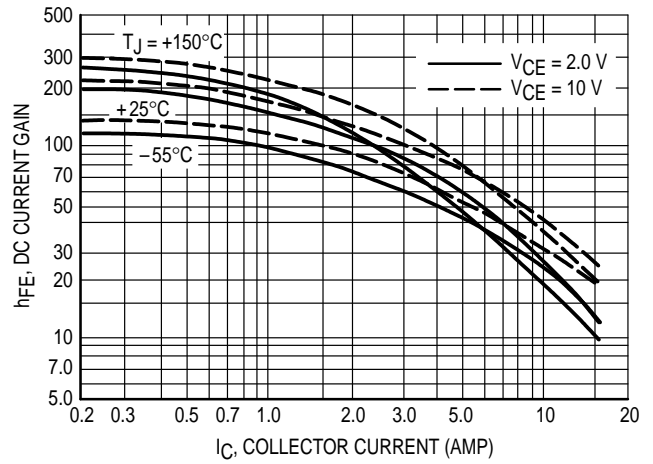
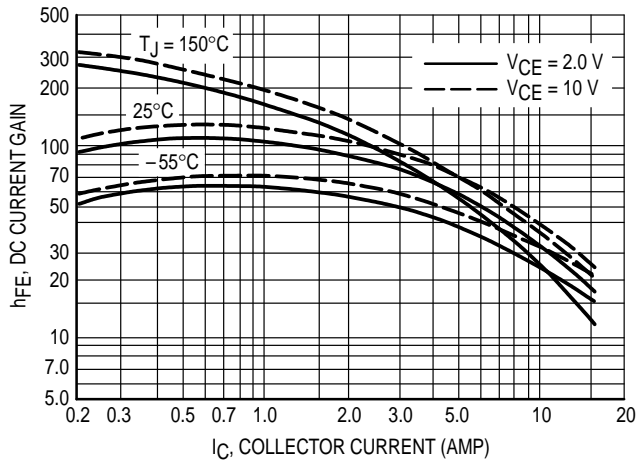

Figure 8. DC Current Gain

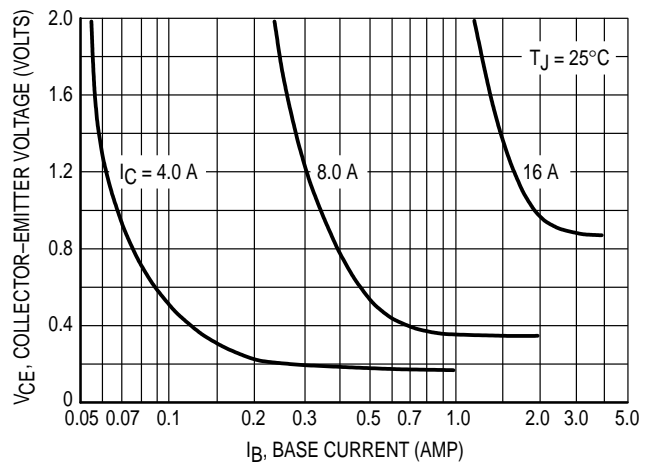
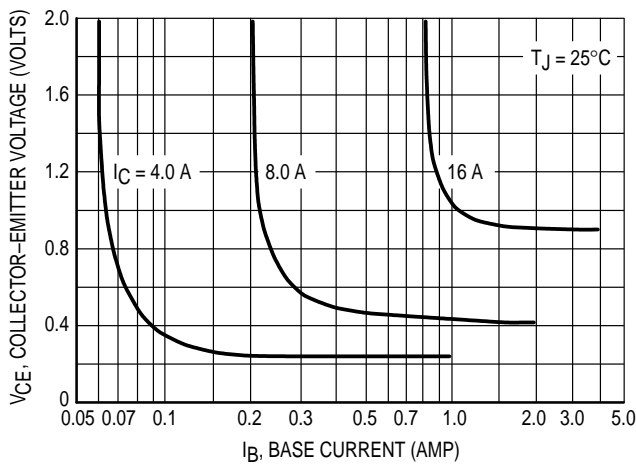
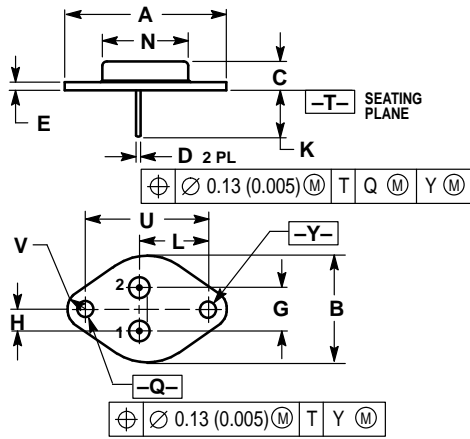

Figure 9. Collector Saturation Region

PACKAGE DIMENSIONS



- NOTES:
1. DIMENSIONING AND TOLERANCING PER ANSI Y14.5M, 1982.
 2. CONTROLLING DIMENSION: INCH.
 3. ALL RULES AND NOTES ASSOCIATED WITH REFERENCED TO-204AA OUTLINE SHALL APPLY.

DIM	INCHES		MILLIMETERS	
	MIN	MAX	MIN	MAX
A	1.550 REF		39.37 REF	
B	—	1.050	—	26.67
C	0.250	0.335	6.35	8.51
D	0.038	0.043	0.97	1.09
E	0.055	0.070	1.40	1.77
G	0.430 BSC		10.92 BSC	
H	0.215 BSC		5.46 BSC	
K	0.440	0.480	11.18	12.19
L	0.665 BSC		16.89 BSC	
N	—	0.830	—	21.08
Q	0.151	0.165	3.84	4.19
U	1.187 BSC		30.15 BSC	
V	0.131	0.188	3.33	4.77

STYLE 1:
 PIN 1. BASE
 2. EMITTER
 CASE: COLLECTOR

CASE 1-07
 TO-204AA (TO-3)
 ISSUE Z

Motorola reserves the right to make changes without further notice to any products herein. Motorola makes no warranty, representation or guarantee regarding the suitability of its products for any particular purpose, nor does Motorola assume any liability arising out of the application or use of any product or circuit, and specifically disclaims any and all liability, including without limitation consequential or incidental damages. "Typical" parameters can and do vary in different applications. All operating parameters, including "Typicals" must be validated for each customer application by customer's technical experts. Motorola does not convey any license under its patent rights nor the rights of others. Motorola products are not designed, intended, or authorized for use as components in systems intended for surgical implant into the body, or other applications intended to support or sustain life, or for any other application in which the failure of the Motorola product could create a situation where personal injury or death may occur. Should Buyer purchase or use Motorola products for any such unintended or unauthorized application, Buyer shall indemnify and hold Motorola and its officers, employees, subsidiaries, affiliates, and distributors harmless against all claims, costs, damages, and expenses, and reasonable attorney fees arising out of, directly or indirectly, any claim of personal injury or death associated with such unintended or unauthorized use, even if such claim alleges that Motorola was negligent regarding the design or manufacture of the part. Motorola and  are registered trademarks of Motorola, Inc. Motorola, Inc. is an Equal Opportunity/Affirmative Action Employer.

How to reach us:

USA / EUROPE: Motorola Literature Distribution;
P.O. Box 20912; Phoenix, Arizona 85036. 1-800-441-2447

JAPAN: Nippon Motorola Ltd.; Tatsumi-SPD-JLDC, Toshikatsu Otsuki,
6F Seibu-Butsuryu-Center, 3-14-2 Tatsumi Koto-Ku, Tokyo 135, Japan. 03-3521-8315

MFAX: RMFAX0@email.sps.mot.com - TOUCHTONE (602) 244-6609
INTERNET: <http://Design-NET.com>

HONG KONG: Motorola Semiconductors H.K. Ltd.; 8B Tai Ping Industrial Park,
51 Ting Kok Road, Tai Po, N.T., Hong Kong. 852-26629298

