

Optocoupler, Phototransistor Output, With Base Connection

Features

- Isolation materials according to UL94-VO
- Pollution degree 2 (DIN/VDE 0110 / resp. IEC 60664)
- Climatic classification 55/100/21 (IEC 60068 part 1)
- Special construction: Therefore, extra low coupling capacity of typical 0.2 pF, high **Common Mode Rejection**
- Low temperature coefficient of CTR
- CTR offered in 3 groups
- Rated isolation voltage (RMS includes DC)
 $V_{IOWM} = 600 V_{RMS}$ (848 V peak)
- Rated recurring peak voltage (repetitive)
 $V_{IORM} = 600 V_{RMS}$
- Creepage current resistance according to VDE 0303/IEC 60112 **Comparative Tracking Index: CTI** ≥ 275
- Thickness through insulation ≥ 0.75 mm
- Lead-free component
- Component in accordance to RoHS 2002/95/EC and WEEE 2002/96/EC

Agency Approvals

- UL1577, File No. E76222 System Code A, Double Protection
- BSI: BS EN 41003, BS EN 60095 (BS 415), BS EN 60950 (BS 7002), Certificate number 7081 and 7402
- DIN EN 60747-5-2 (VDE0884)
DIN EN 60747-5-5 pending
- VDE related features:
- Rated impulse voltage (transient overvoltage)
 $V_{IOTM} = 6$ kV peak
- Isolation test voltage (partial discharge test voltage) $V_{pd} = 1.6$ kV
- FIMKO (SETI): EN 60950, Certificate No. 12399

Applications

Circuits for safe protective separation against electrical shock according to safety class II (reinforced isolation):

For appl. class I - IV at mains voltage ≤ 300 V

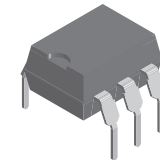
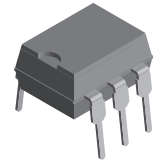
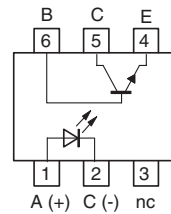

17186

For appl. class I - III at mains voltage ≤ 600 V according to DIN EN 60747-5-2(VDE0884)/ DIN EN 60747-5-5 pending, table 2, suitable for:

Switch-mode power supplies, line receiver, computer peripheral interface, microprocessor system interface.

Description

The CNY75A/ B/ C/ GA/ GB/ GC consists of a phototransistor optically coupled to a gallium arsenide infrared-emitting diode in a 6-pin plastic dual in-line package.

The elements are mounted on one leadframe providing a fixed distance between input and output for highest safety requirements.

VDE Standards

These couplers perform safety functions according to the following equipment standards:

DIN EN 60747-5-2(VDE0884)/ DIN EN 60747-5-5 pending

Optocoupler for electrical safety requirements
IEC 60950/ EN 60950

Office machines (applied for reinforced isolation for mains voltage ≤ 400 VRMS)

VDE 0804

Telecommunication apparatus and data processing
IEC 60065

Safety for mains-operated electronic and related house hold apparatus

Order Information

| Part | Remarks |
|---------|------------------------|
| CNY75A | CTR 63 - 125 %, DIP-6 |
| CNY75B | CTR 100 - 200 %, DIP-6 |
| CNY75C | CTR 160 - 320 %, DIP-6 |
| CNY75GA | CTR 63 - 125 %, DIP-6 |
| CNY75GB | CTR 100 - 200 %, DIP-6 |
| CNY75GC | CTR 160 - 320 %, DIP-6 |

G = Leadform 10.16 mm; G is not marked on the body

For additional information on the available options refer to Option Information.

Absolute Maximum Ratings

$T_{amb} = 25\text{ }^{\circ}\text{C}$, unless otherwise specified

Stresses in excess of the absolute Maximum Ratings can cause permanent damage to the device. Functional operation of the device is not implied at these or any other conditions in excess of those given in the operational sections of this document. Exposure to absolute Maximum Rating for extended periods of the time can adversely affect reliability.

Input

| Parameter | Test condition | Symbol | Value | Unit |
|-----------------------|----------------------------------|------------|-------|--------------------|
| Reverse voltage | | V_R | 5 | V |
| Forward current | | I_F | 60 | mA |
| Forward surge current | $t_p \leq 10\text{ }\mu\text{s}$ | I_{FSM} | 3 | A |
| Power dissipation | | P_{diss} | 100 | mW |
| Junction temperature | | T_j | 125 | $^{\circ}\text{C}$ |

Output

| Parameter | Test condition | Symbol | Value | Unit |
|---------------------------|---|------------|-------|--------------------|
| Collector base voltage | | V_{CBO} | 90 | V |
| Collector emitter voltage | | V_{CEO} | 90 | V |
| Emitter collector voltage | | V_{ECO} | 7 | V |
| Collector current | | I_C | 50 | mA |
| Collector peak current | $t_p/T = 0.5$, $t_p \leq 10\text{ ms}$ | I_{CM} | 100 | mA |
| Power dissipation | | P_{diss} | 150 | mW |
| Junction temperature | | T_j | 125 | $^{\circ}\text{C}$ |

Coupler

| Parameter | Test condition | Symbol | Value | Unit |
|---------------------------------|--------------------------------------|-----------|---------------|--------------------|
| AC isolation test voltage (RMS) | $t = 1\text{ min}$ | V_{ISO} | 3750 | V_{RMS} |
| Total power dissipation | | P_{tot} | 250 | mW |
| Ambient temperature range | | T_{amb} | - 55 to + 100 | $^{\circ}\text{C}$ |
| Storage temperature range | | T_{stg} | - 55 to + 125 | $^{\circ}\text{C}$ |
| Soldering temperature | 2 mm from case, $t \leq 10\text{ s}$ | T_{sld} | 260 | $^{\circ}\text{C}$ |



Electrical Characteristics

T_{amb} = 25 °C, unless otherwise specified

Minimum and maximum values are testing requirements. Typical values are characteristics of the device and are the result of engineering evaluation. Typical values are for information only and are not part of the testing requirements.

Input

| Parameter | Test condition | Symbol | Min | Typ. | Max | Unit |
|----------------------|-------------------------------|----------------|-----|------|-----|------|
| Forward voltage | I _F = 50 mA | V _F | | 1.25 | 1.6 | V |
| Reverse current | V _R = 6 V | I _R | | | 10 | μA |
| Junction capacitance | V _R = 0, f = 1 MHz | C _j | | 50 | | pF |

Output

| Parameter | Test condition | Symbol | Min | Typ. | Max | Unit |
|-----------------------------------|--|------------------|-----|------|-----|------|
| Collector base voltage | I _C = 100 μA | V _{CBO} | 90 | | | V |
| Collector emitter voltage | I _C = 1 mA | V _{CEO} | 90 | | | V |
| Emitter collector voltage | I _E = 100 μA | V _{ECO} | 7 | | | V |
| Collector-emitter leakage current | V _{CE} = 20 V, I _F = 0 | I _{CEO} | | | 150 | nA |

Coupler

| Parameter | Test condition | Symbol | Min | Typ. | Max | Unit |
|--------------------------------------|---|--------------------|-----|------|-----|------|
| Collector emitter saturation voltage | I _F = 10 mA, I _C = 1 mA | V _{CEsat} | | | 0.3 | V |
| Cut-off frequency | V _{CE} = 5 V, I _F = 10 mA, R _L = 100 Ω | f _c | | 110 | | kHz |
| Coupling capacitance | f = 1 MHz | C _k | | 0.3 | | pF |

Current Transfer Ratio

| Parameter | Test condition | Part | Symbol | Min | Typ. | Max | Unit |
|--------------------------------|---|---------|--------|-----|------|------|------|
| I _C /I _F | V _{CE} = 5 V, I _F = 1 mA | CNY75GA | CTR | 15 | | | % |
| | | CNY75GB | CTR | 30 | | | % |
| | | CNY75GC | CTR | 60 | | | % |
| | V _{CE} = 5 V, I _F = 10 mA | CNY75GA | CTR | 63 | | 1.25 | % |
| | | CNY75GB | CTR | 100 | | 200 | % |
| | | CNY75GC | CTR | 160 | | 320 | % |

Switching Characteristics

| Parameter | Current | Delay | Rise time | Storage | Fall time | Turn-on time | Turn-off time | Turn-on time | Turn-off time |
|----------------|--|----------------|----------------|----------------|----------------|-----------------|------------------|---|------------------|
| Test condition | V _{CC} = 5 V, R _L = 100 Ω (see figure 3) | | | | | | | V _{CC} = 5 V, R _L = 1.0 kΩ (see figure 4) | |
| Symbol | I _F | t _D | t _r | t _S | t _f | t _{on} | t _{off} | t _{on} | t _{off} |
| Unit | mA | μs | μs | μs | μs | μs | μs | μs | μs |
| CNY75GA | 10 | 2.0 | 2.5 | 0.3 | 2.7 | 4.5 | 3.0 | 10.0 | 25.0 |
| CNY75GB | 10 | 2.5 | 3.0 | 0.3 | 3.7 | 5.5 | 4.0 | 16.5 | 20.0 |
| CNY75GC | 10 | 2.8 | 4.2 | 0.3 | 4.7 | 7.0 | 5.0 | 11.0 | 37.5 |

Maximum Safety Ratings

(according to DIN EN 60747-5-2(VDE0884)/ DIN EN 60747-5-5 pending) see figure 1
 This optocoupler is suitable for safe electrical isolation only within the safety ratings.
 Compliance with the safety ratings shall be ensured by means of suitable protective circuits.

Input

| Parameter | Test condition | Symbol | Min | Typ. | Max | Unit |
|-----------------|----------------|--------|-----|------|-----|------|
| Forward current | | I_F | | | 130 | mA |

Output

| Parameter | Test condition | Symbol | Min | Typ. | Max | Unit |
|-------------------|----------------|------------|-----|------|-----|------|
| Power dissipation | | P_{diss} | | | 265 | mW |

Coupler

| Parameter | Test condition | Symbol | Min | Typ. | Max | Unit |
|-----------------------|----------------|------------|-----|------|-----|------|
| Rated impulse voltage | | V_{IOTM} | | | 6 | kV |
| Safety temperature | | T_{si} | | | 150 | °C |

Insulation Rated Parameters

| Parameter | Test condition | Symbol | Min | Typ. | Max | Unit |
|---|--|------------|-----------|------|-----|----------|
| Partial discharge test voltage - Routine test | 100 %, $t_{test} = 1$ s | V_{pd} | 1.6 | | | kV |
| Partial discharge test voltage - Lot test (sample test) | $t_{Tr} = 60$ s, $t_{test} = 10$ s, (see figure 2) | V_{IOTM} | 6 | | | kV |
| | | V_{pd} | 1.3 | | | kV |
| Insulation resistance | $V_{IO} = 500$ V | R_{IO} | 10^{12} | | | Ω |
| | $V_{IO} = 500$ V, $T_{amb} \leq 100$ °C | R_{IO} | 10^{11} | | | Ω |
| | $V_{IO} = 500$ V, $T_{amb} \leq 150$ °C (construction test only) | R_{IO} | 10^9 | | | Ω |

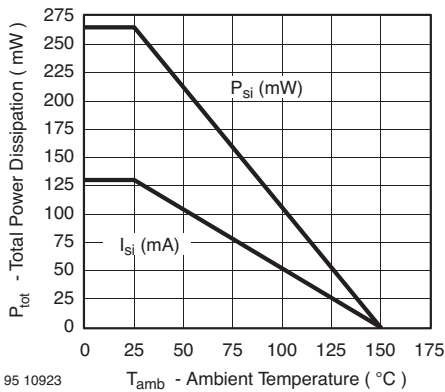

Figure 1. Derating diagram

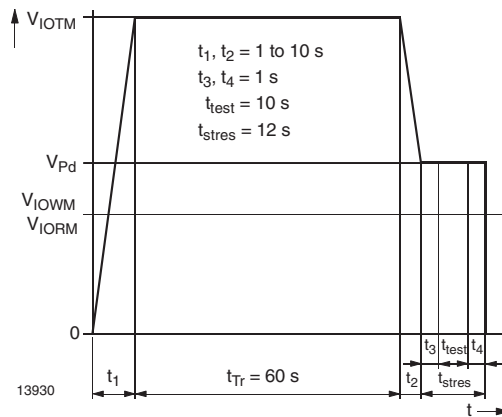

Figure 2. Test pulse diagram for sample test according to DIN EN 60747-5-2(VDE0884)/ DIN EN 60747-5; IEC60747

Typical Characteristics ($T_{amb} = 25\text{ }^{\circ}\text{C}$ unless otherwise specified)

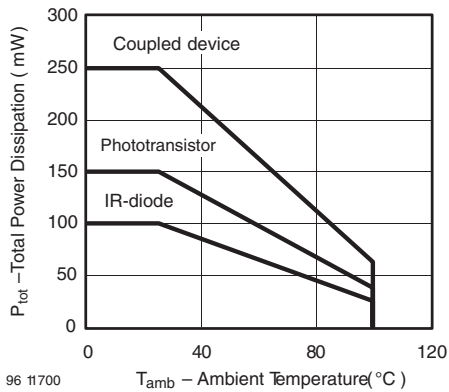

Figure 3. Total Power Dissipation vs. Ambient Temperature

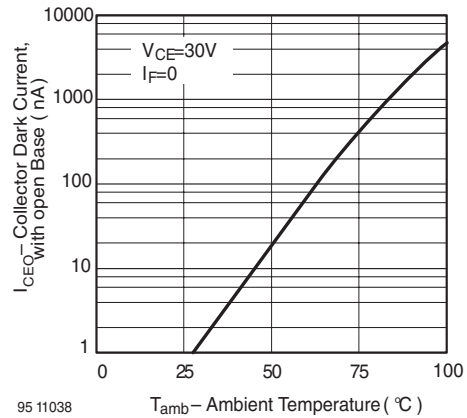

Figure 6. Collector Dark Current vs. Ambient Temperature

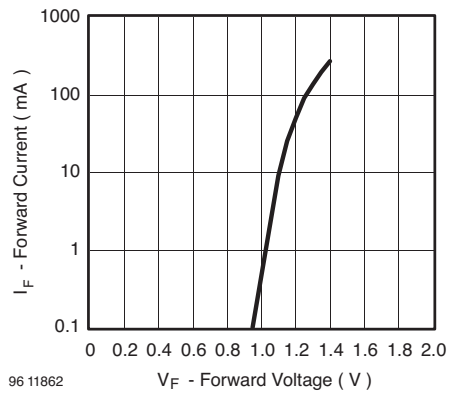

Figure 4. Forward Current vs. Forward Voltage

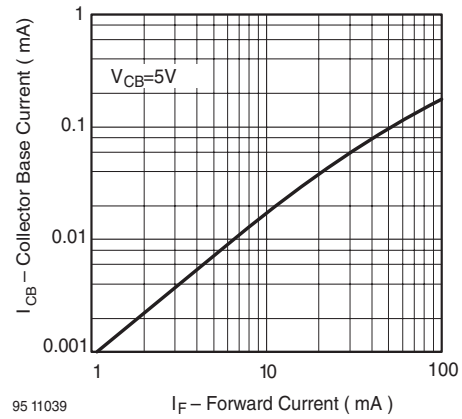

Figure 7. Collector Base Current vs. Forward Current

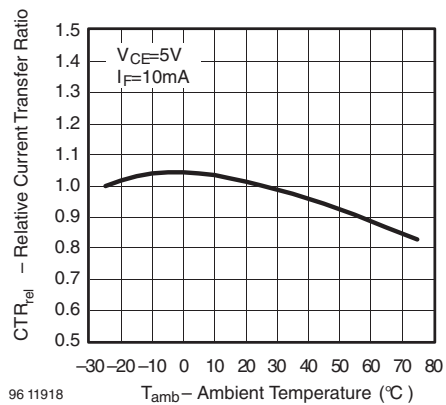

Figure 5. Relative Current Transfer Ratio vs. Ambient Temperature

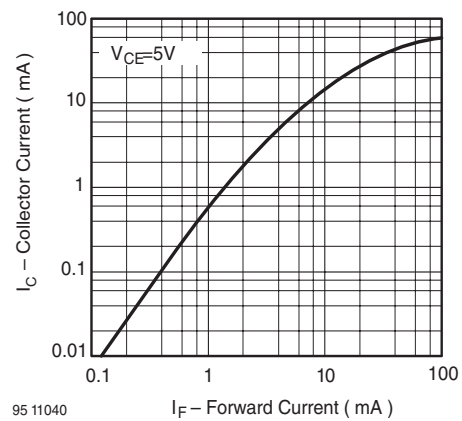

Figure 8. Collector Current vs. Forward Current

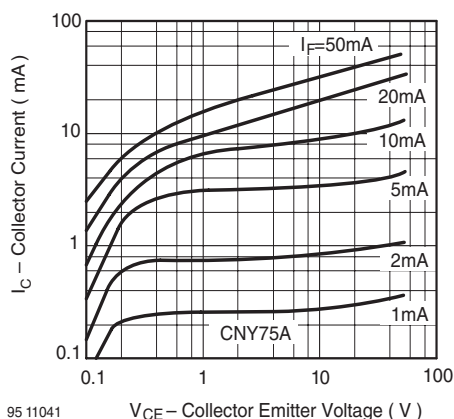

Figure 9. Collector Current vs. Collector Emitter Voltage

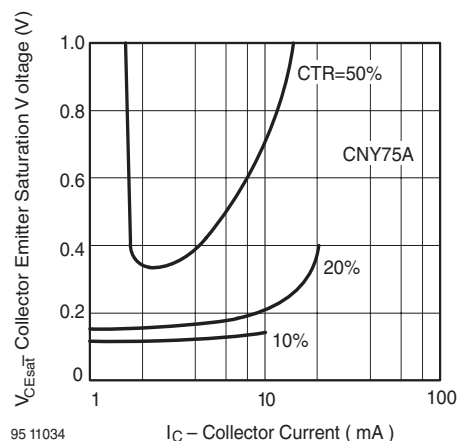

Figure 12. Collector Emitter Saturation Voltage vs. Collector Current

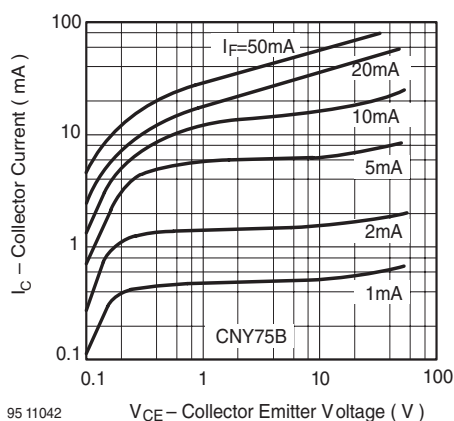

Figure 10. Collector Current vs. Collector Emitter Voltage

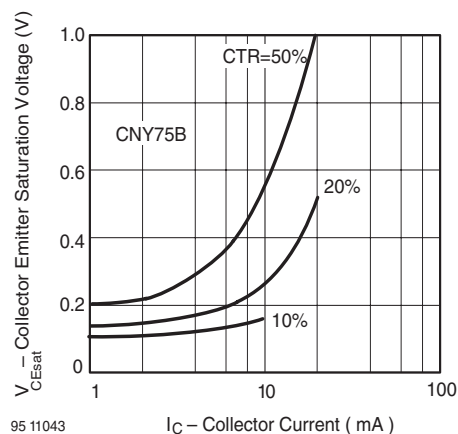

Figure 13. Collector Emitter Saturation Voltage vs. Collector Current

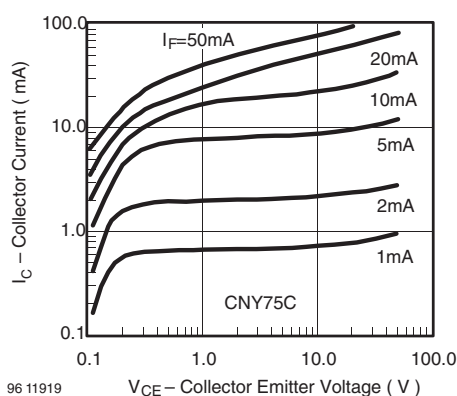

Figure 11. Collector Current vs. Collector Emitter Voltage

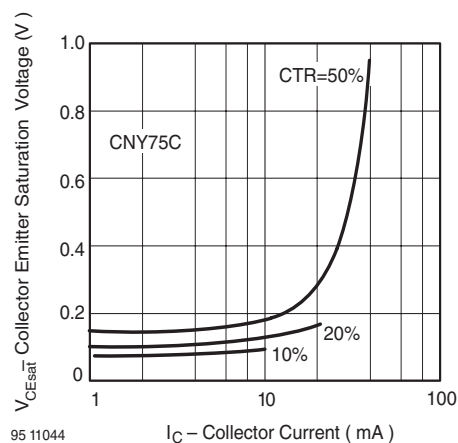

Figure 14. Collector Emitter Saturation Voltage vs. Collector Current

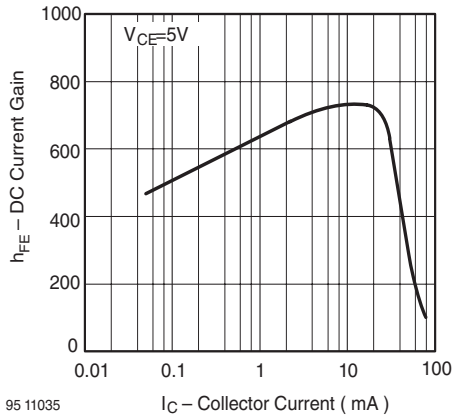

Figure 15. DC Current Gain vs. Collector Current

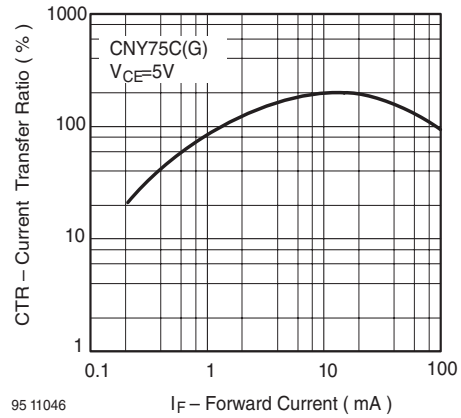

Figure 18. Current Transfer Ratio vs. Forward Current

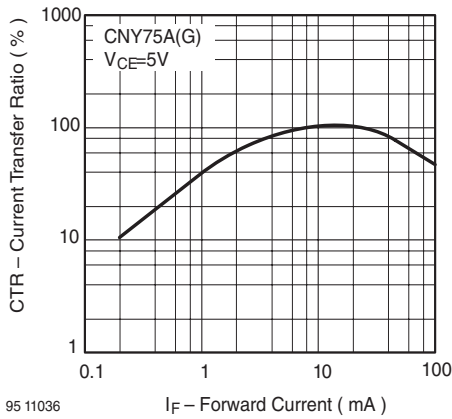

Figure 16. Current Transfer Ratio vs. Forward Current

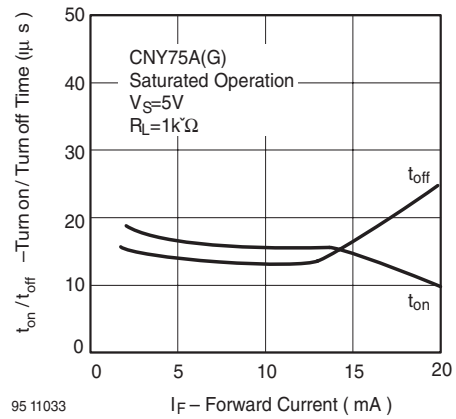

Figure 19. Turn on / off Time vs. Forward Current

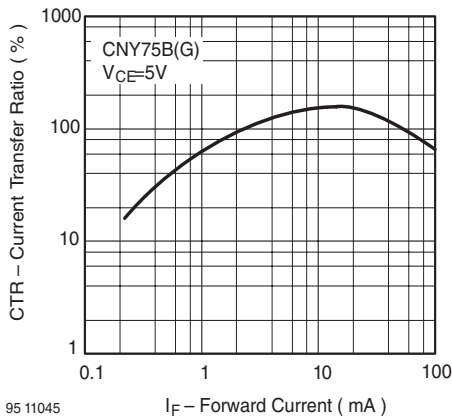

Figure 17. Current Transfer Ratio vs. Forward Current

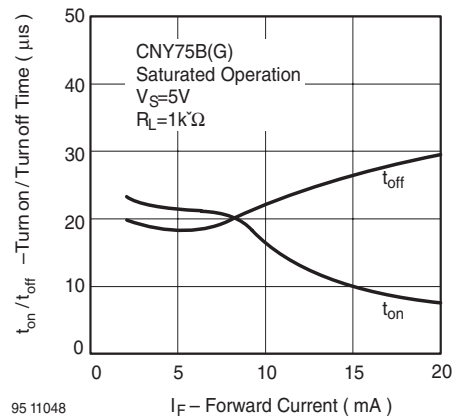

Figure 20. Turn on / off Time vs. Forward Current

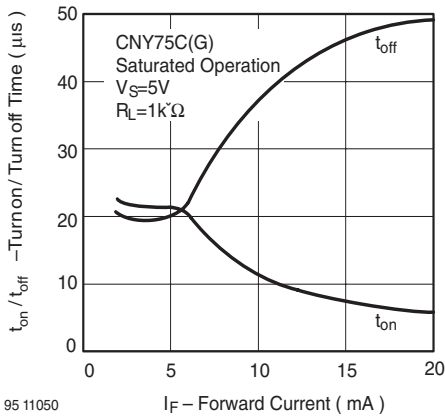

Figure 21. Turn on / off Time vs. Forward Current

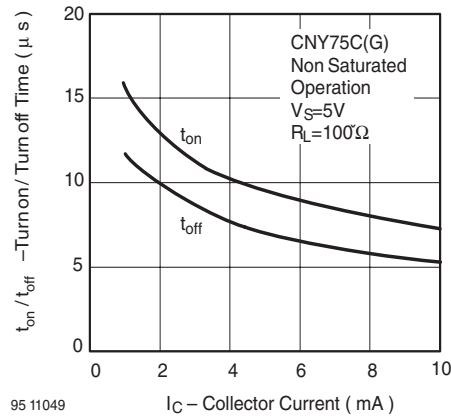

Figure 24. Turn on / off Time vs. Collector Current

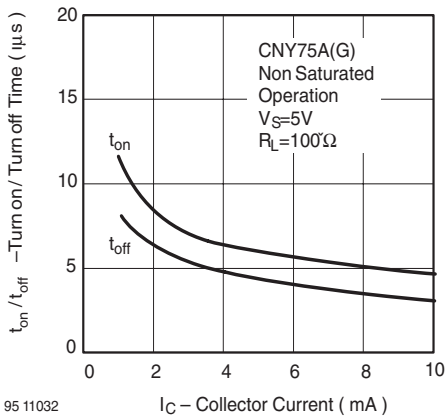

Figure 22. Turn on / off Time vs. Collector Current

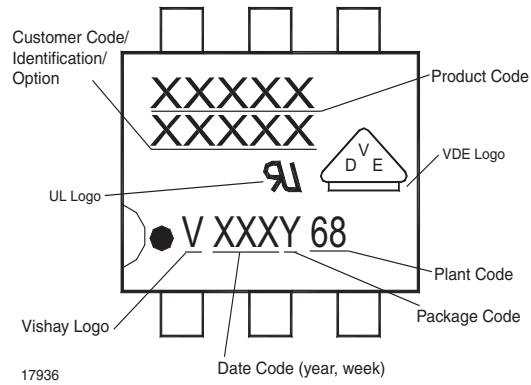

Figure 25. Marking example

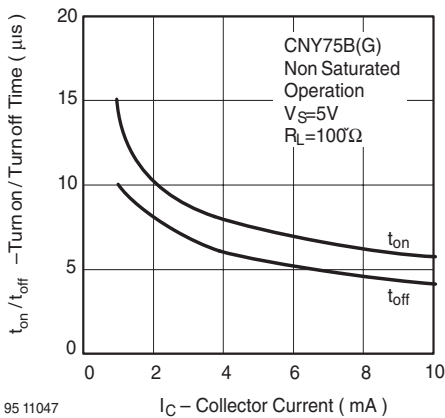
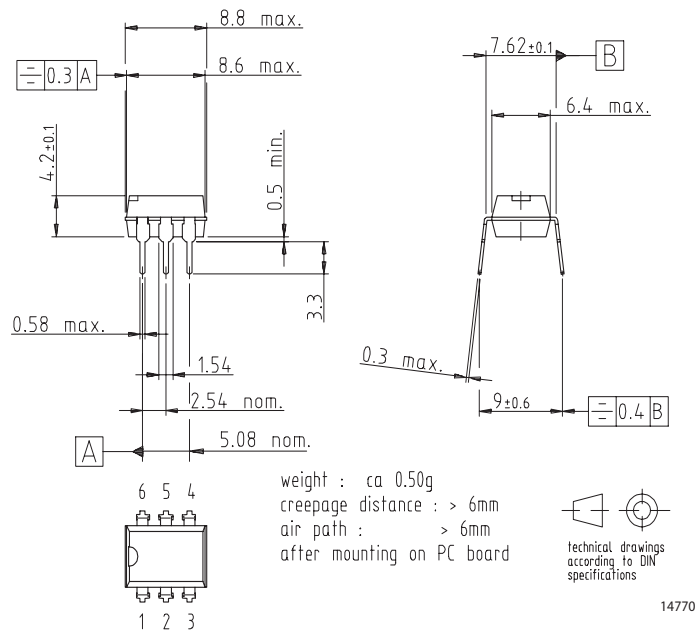
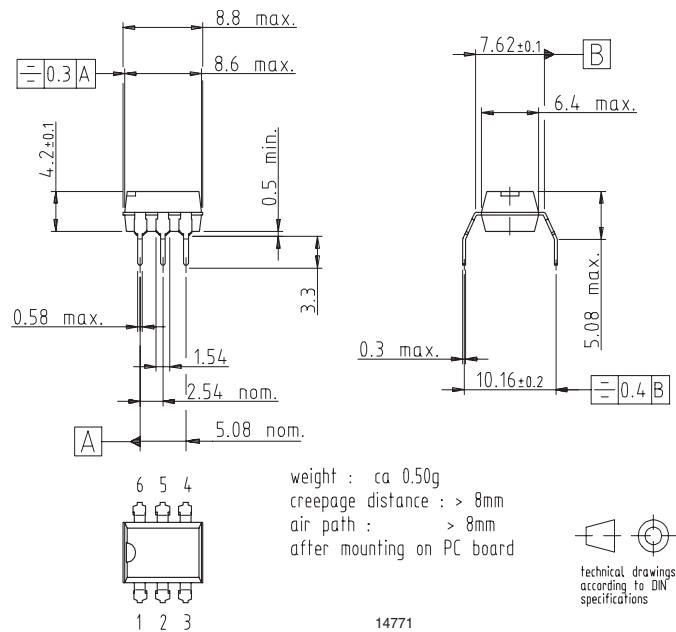

Figure 23. Turn on / off Time vs. Collector Current

Package Dimensions in mm



Package Dimensions in mm



Ozone Depleting Substances Policy Statement

It is the policy of Vishay Semiconductor GmbH to

1. Meet all present and future national and international statutory requirements.
2. Regularly and continuously improve the performance of our products, processes, distribution and operating systems with respect to their impact on the health and safety of our employees and the public, as well as their impact on the environment.

It is particular concern to control or eliminate releases of those substances into the atmosphere which are known as ozone depleting substances (ODSs).

The Montreal Protocol (1987) and its London Amendments (1990) intend to severely restrict the use of ODSs and forbid their use within the next ten years. Various national and international initiatives are pressing for an earlier ban on these substances.

Vishay Semiconductor GmbH has been able to use its policy of continuous improvements to eliminate the use of ODSs listed in the following documents.

1. Annex A, B and list of transitional substances of the Montreal Protocol and the London Amendments respectively
2. Class I and II ozone depleting substances in the Clean Air Act Amendments of 1990 by the Environmental Protection Agency (EPA) in the USA
3. Council Decision 88/540/EEC and 91/690/EEC Annex A, B and C (transitional substances) respectively.

Vishay Semiconductor GmbH can certify that our semiconductors are not manufactured with ozone depleting substances and do not contain such substances.

We reserve the right to make changes to improve technical design
and may do so without further notice.

Parameters can vary in different applications. All operating parameters must be validated for each customer application by the customer. Should the buyer use Vishay Semiconductors products for any unintended or unauthorized application, the buyer shall indemnify Vishay Semiconductors against all claims, costs, damages, and expenses, arising out of, directly or indirectly, any claim of personal damage, injury or death associated with such unintended or unauthorized use.

Vishay Semiconductor GmbH, P.O.B. 3535, D-74025 Heilbronn, Germany
Telephone: 49 (0)7131 67 2831, Fax number: 49 (0)7131 67 2423