

# TLP3507

TRIAC DRIVER

PROGRAMMABLE CONTROLLERS

AC-OUTPUT MODULE

SOLID STATE RELAY

The TOSHIBA TLP3507 consists of a zero voltage crossing turn-on photo-triac optically coupled to a gallium arsenide infrared emitting diode in a 8 lead plastic DIP package.

- Peak Off-State Voltage : 600V (MIN.)
- Trigger LED Current : 10mA (MAX.)
- On-State Current : 0.5A<sub>rms</sub> (MAX.)
- Isolation Voltage : 2500V<sub>rms</sub> (MIN.)
- Zero Crossing Function
- UL Recognized : UL1577, File No. E67349

Unit in mm

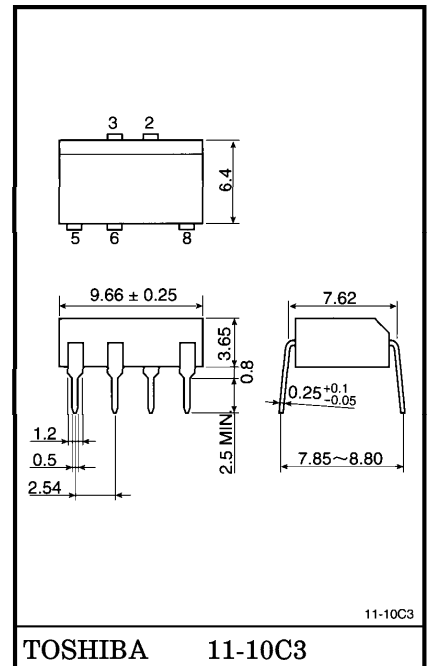

Weight : 0.52g

**PIN CONFIGURATIONS (TOP VIEW)**

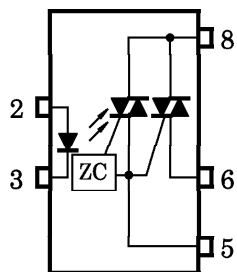

- 2 : ANODE
- 3 : CATHODE
- 5 : TRIAC GATE
- 6 : TRIAC T1
- 8 : TRIAC T2

## MAXIMUM RATINGS (Ta = 25°C)

CHARACTERISTIC		SYMBOL	RATING	UNIT
LED	Forward Current	$I_F$	50	mA
	Forward Current Derating (Ta ≥ 53°C)	$\Delta I_F / ^\circ\text{C}$	-0.7	mA / °C
	Peak Forward Current (100μs pulse, 100pps)	$I_{FP}$	1	A
	Reverse Voltage	$V_R$	5	V
	Junction Temperature	$T_j$	125	°C
DETECTOR	Off-State Output Terminal Voltage	$V_{DRM}$	600	V
	On-State RMS Current	Ta = 40°C	0.5	A
		Ta = 60°C	0.35	
	On-State Current Derating (Ta ≥ 40°C)	$\Delta I_T / ^\circ\text{C}$	-7.2	mA / °C
	Peak Current from Snubber Circuit (100μs pulse, 120pps)	$I_{SP}$	2	A
	Peak Nonrepetitive Surge Current (50Hz, Peak)	$I_{TSM}$	5	A
	Junction Temperature	$T_j$	110	°C
Storage Temperature Range	$T_{stg}$	-40~125	°C	
Operating Temperature Range	$T_{opr}$	-20~80	°C	
Lead Soldering Temperature (10s)	$T_{sol}$	260	°C	
Isolation Voltage (AC, 1 min., R.H. ≤ 60%) (Note)	$BV_S$	2500	$V_{rms}$	

(Note) Device considered a two-terminal device : Pins 2 and 3 shorted together, and pins 5, 6 and 8 shorted together.

## RECOMMENDED OPERATING CONDITIONS

CHARACTERISTIC	SYMBOL	MIN.	TYP.	MAX.	UNIT
Supply Voltage	$V_{AC}$	—	—	240	$V_{ac}$
Forward Current	$I_F$	15	20	25	mA
Peak Current from Snubber Circuit	$I_{SP}$	—	—	1	A
Operating Temperature	$T_{opr}$	-20	—	80	°C

INDIVIDUAL ELECTRICAL CHARACTERISTICS (Ta = 25°C)

CHARACTERISTIC		SYMBOL	TEST CONDITION	MIN.	TYP.	MAX.	UNIT
LED	Forward Voltage	$V_F$	$I_F = 10\text{mA}$	1.0	1.15	1.3	V
	Reverse Current	$I_R$	$V_R = 5\text{V}$	—	—	10	$\mu\text{A}$
	Capacitance	$C_T$	$V = 0, f = 1\text{MHz}$	—	30	—	pF
DETECTOR	Peak Off-State Current	$I_{DRM}$	$V_{DRM} = 600\text{V}, T_a = 110^\circ\text{C}$	—	—	100	$\mu\text{A}$
	Peak On-State Voltage	$V_{TM}$	$I_{TM} = 0.75\text{A}$	—	—	3.0	V
	Holding Current	$I_H$	$R_L = 100\Omega$	—	—	25	mA
	Critical Rate of Rise of Off-State Voltage	$dv/dt$	$V_{in} = 240V_{rms}$ (Fig.1)	—	500	—	$V/\mu\text{s}$
	Critical Rate of Rise of Commutating Voltage	$dv/dt(c)$	$V_{in} = 240V_{rms}, I_T = 0.5A_{rms}$ (Fig.1)	—	5	—	$V/\mu\text{s}$

COUPLED ELECTRICAL CHARACTERISTICS (Ta = 25°C)

CHARACTERISTIC	SYMBOL	TEST CONDITION	MIN.	TYP.	MAX.	UNIT
Trigger LED Current	$I_{FT}$	$V_T = 6\text{V}$	—	—	10	mA
Inhibit Voltage	$V_{IH}$	$I_F = \text{Rated } I_{FT}$	—	—	50	V
Leakage in Inhibited State	$I_{IH}$	$I_F = \text{Rated } I_{FT}$ $V_T = \text{Rated } V_{DRM}$	—	200	—	$\mu\text{A}$
Capacitance (Input to Output)	$C_S$	$V_S = 0, f = 1\text{MHz}$	—	1.5	—	pF
Isolation Resistance	$R_S$	$V_S = 500\text{V}, \text{R.H.} \leq 60\%$	$5 \times 10^{10}$	$10^{14}$	—	$\Omega$
Isolation Voltage	$BV_S$	AC, 1 minute	2500	—	—	$V_{rms}$
		AC, 1 second, in oil	—	5000	—	
		DC, 1 minute, in oil	—	5000	—	$V_{dc}$

Fig.1 :  $dv/dt$  TEST CIRCUIT

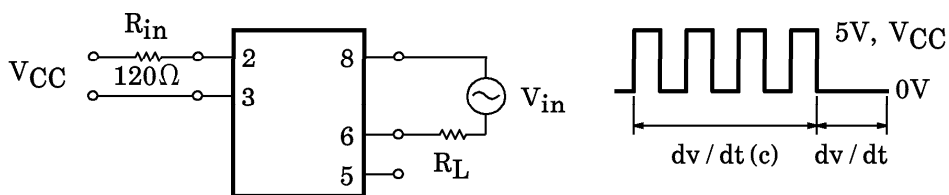

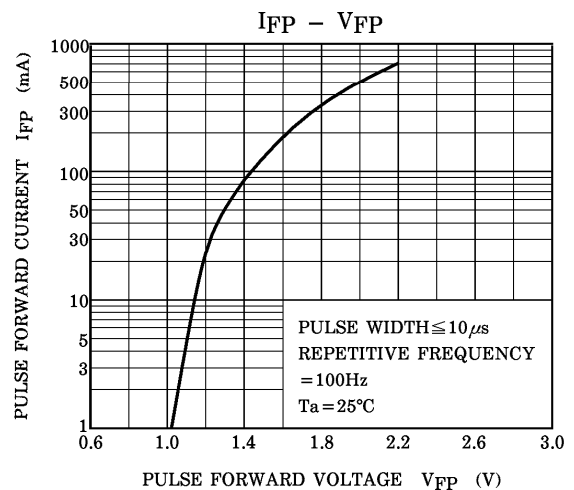
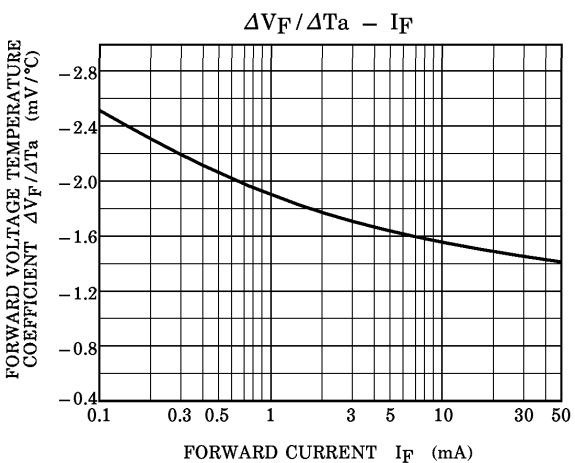
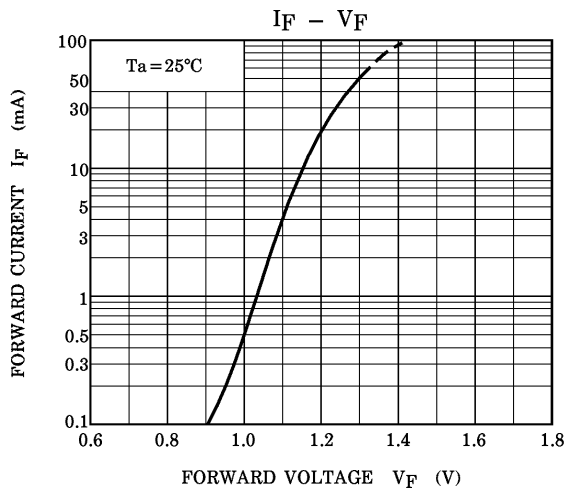
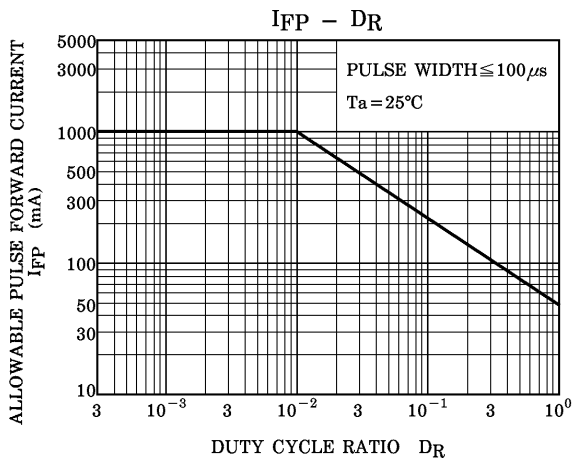
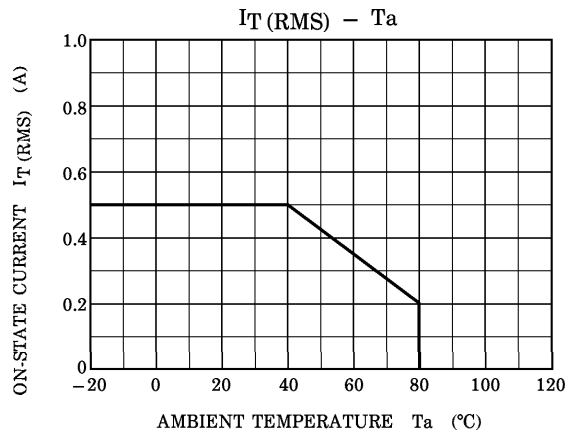
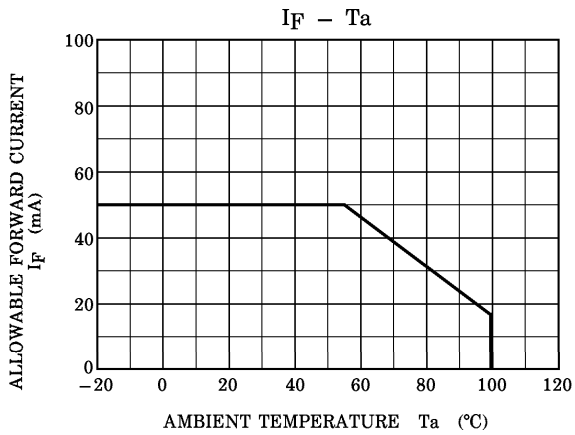

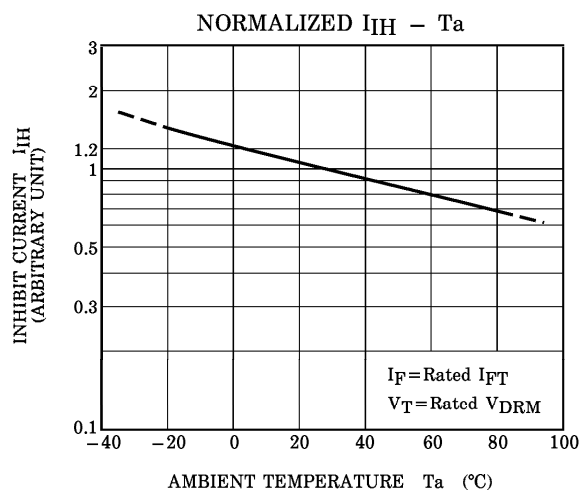
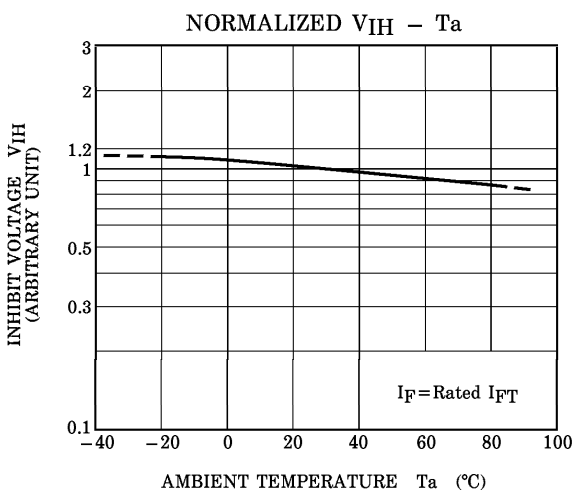
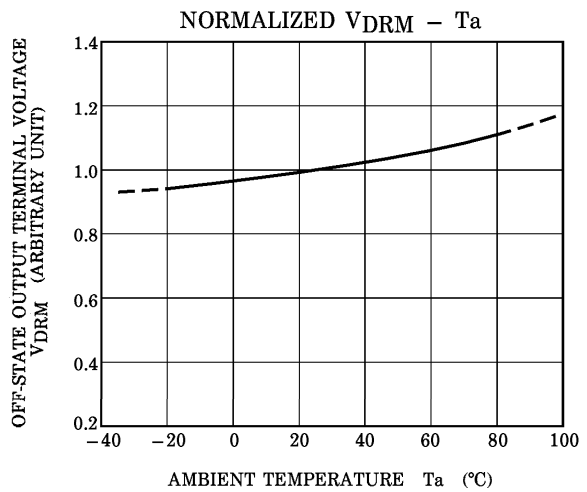
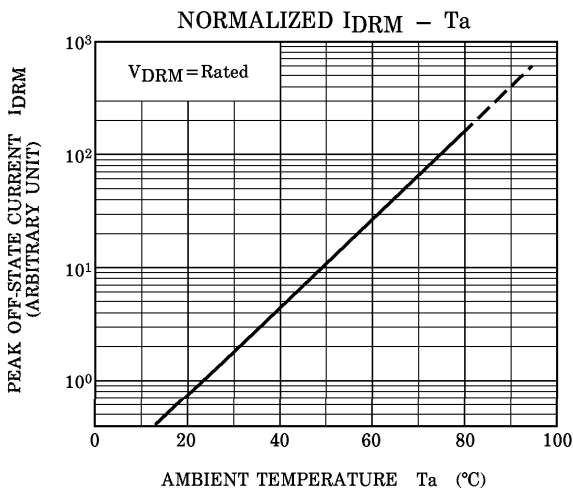
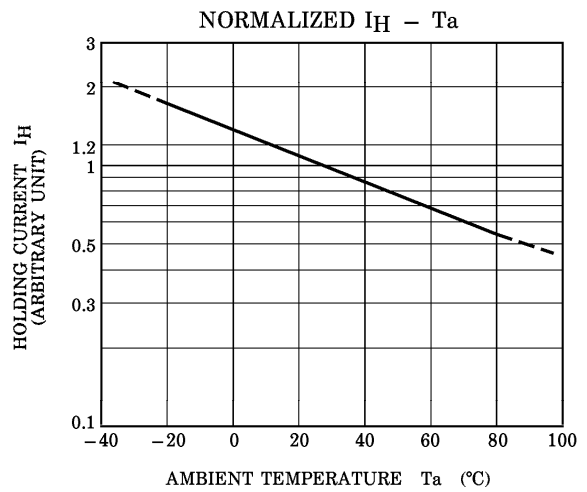
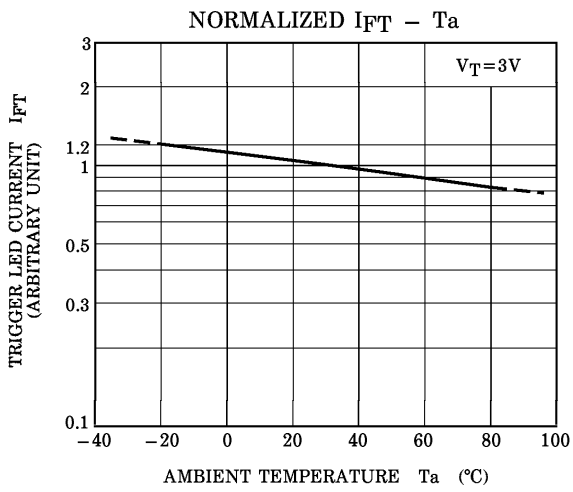

**RESTRICTIONS ON PRODUCT USE**

000707EBC

- TOSHIBA is continually working to improve the quality and reliability of its products. Nevertheless, semiconductor devices in general can malfunction or fail due to their inherent electrical sensitivity and vulnerability to physical stress. It is the responsibility of the buyer, when utilizing TOSHIBA products, to comply with the standards of safety in making a safe design for the entire system, and to avoid situations in which a malfunction or failure of such TOSHIBA products could cause loss of human life, bodily injury or damage to property. In developing your designs, please ensure that TOSHIBA products are used within specified operating ranges as set forth in the most recent TOSHIBA products specifications. Also, please keep in mind the precautions and conditions set forth in the "Handling Guide for Semiconductor Devices," or "TOSHIBA Semiconductor Reliability Handbook" etc..
- The TOSHIBA products listed in this document are intended for usage in general electronics applications (computer, personal equipment, office equipment, measuring equipment, industrial robotics, domestic appliances, etc.). These TOSHIBA products are neither intended nor warranted for usage in equipment that requires extraordinarily high quality and/or reliability or a malfunction or failure of which may cause loss of human life or bodily injury ("Unintended Usage"). Unintended Usage include atomic energy control instruments, airplane or spaceship instruments, transportation instruments, traffic signal instruments, combustion control instruments, medical instruments, all types of safety devices, etc.. Unintended Usage of TOSHIBA products listed in this document shall be made at the customer's own risk.
- Gallium arsenide (GaAs) is a substance used in the products described in this document. GaAs dust and fumes are toxic. Do not break, cut or pulverize the product, or use chemicals to dissolve them. When disposing of the products, follow the appropriate regulations. Do not dispose of the products with other industrial waste or with domestic garbage.
- The products described in this document are subject to the foreign exchange and foreign trade laws.
- The information contained herein is presented only as a guide for the applications of our products. No responsibility is assumed by TOSHIBA CORPORATION for any infringements of intellectual property or other rights of the third parties which may result from its use. No license is granted by implication or otherwise under any intellectual property or other rights of TOSHIBA CORPORATION or others.
- The information contained herein is subject to change without notice.