

SFR601 – SFR607

6.0A SOFT FAST RECOVERY RECTIFIER

Features

- Diffused Junction
- Low Forward Voltage Drop
- High Current Capability
- High Reliability
- High Surge Current Capability

Mechanical Data

- Case: Molded Plastic
- Terminals: Plated Leads Solderable per MIL-STD-202, Method 208
- Polarity: Cathode Band
- Weight: 2.1 grams (approx.)
- Mounting Position: Any
- Marking: Type Number
- Epoxy: UL 94V-O rate flame retardant

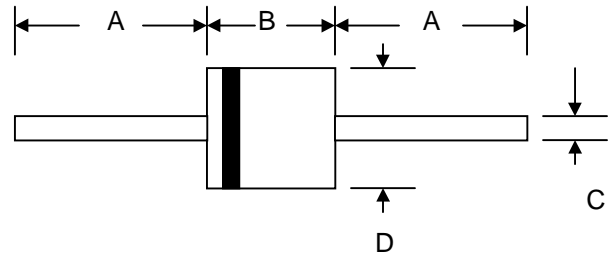

R-6		
Dim	Min	Max
A	25.4	—
B	8.60	9.10
C	1.20	1.30
D	8.60	9.10
All Dimensions in mm		

Maximum Ratings and Electrical Characteristics @ $T_A=25^\circ\text{C}$ unless otherwise specified

Single Phase, half wave, 60Hz, resistive or inductive load.
 For capacitive load, derate current by 20%.

Characteristic	Symbol	SFR601	SFR602	SFR603	SFR604	SFR605	SFR606	SFR607	Unit
Peak Repetitive Reverse Voltage	V_{RRM}								
Working Peak Reverse Voltage	V_{RWM}	50	100	200	400	600	800	1000	V
DC Blocking Voltage	V_R								
RMS Reverse Voltage	$V_{R(RMS)}$	35	70	140	280	420	560	700	V
Average Rectified Output Current (Note 1) @ $T_A = 55^\circ\text{C}$	I_O	6.0							A
Non-Repetitive Peak Forward Surge Current 8.3ms Single half sine-wave superimposed on rated load (JEDEC Method)	I_{FSM}	200							A
Forward Voltage @ $I_F = 6.0\text{A}$	V_{FM}	1.2							V
Peak Reverse Current At Rated DC Blocking Voltage @ $T_A = 25^\circ\text{C}$ @ $T_A = 100^\circ\text{C}$	I_{RM}	10 200							μA
Reverse Recovery Time (Note 2)	t_{rr}	120				200	350		nS
Typical Junction Capacitance (Note 3)	C_j	100							pF
Operating Temperature Range	T_j	-65 to +125							$^\circ\text{C}$
Storage Temperature Range	T_{STG}	-65 to +150							$^\circ\text{C}$

*Glass passivated forms are available upon request

Note: 1. Leads maintained at ambient temperature at a distance of 9.5mm from the case

2. Measured with $I_F = 0.5\text{A}$, $I_R = 1.0\text{A}$, $IRR = 0.25\text{A}$. See figure 5.

3. Measured at 1.0 MHz and applied reverse voltage of 4.0V D.C.

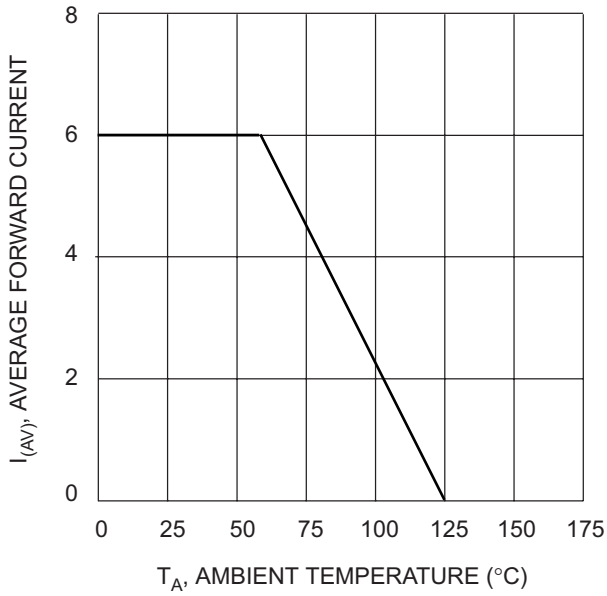

Fig. 1, Typical Forward Current Derating Curve

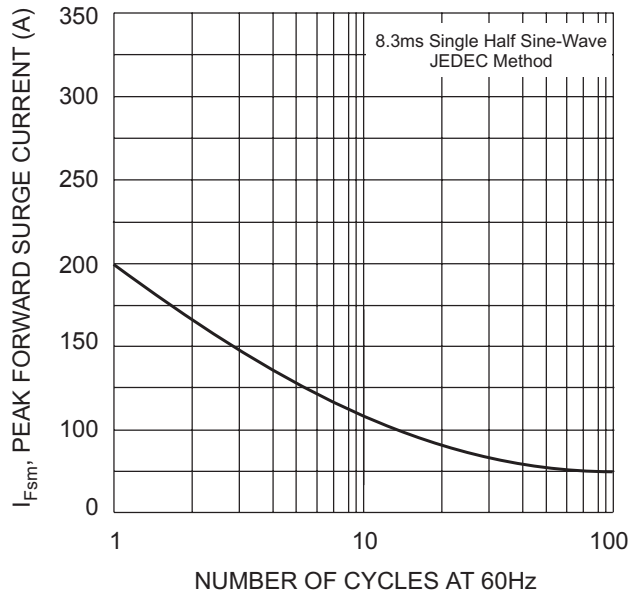

Fig. 2 Max Non-Repetitive Peak Surge Current

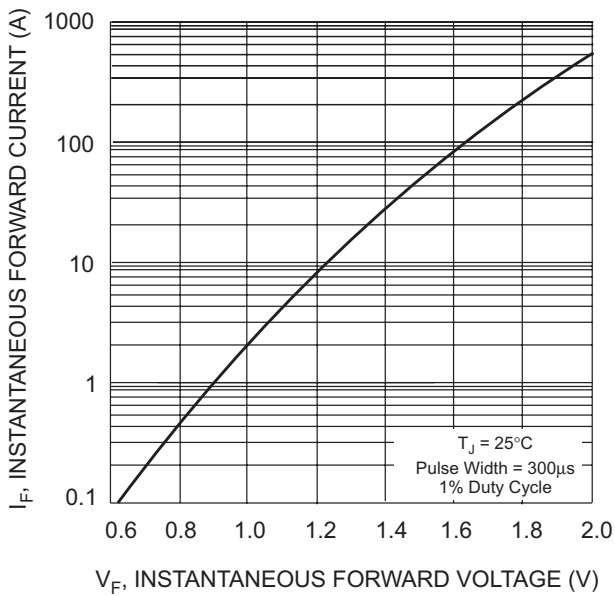

Fig. 3, Typical Instantaneous Forward Characteristics

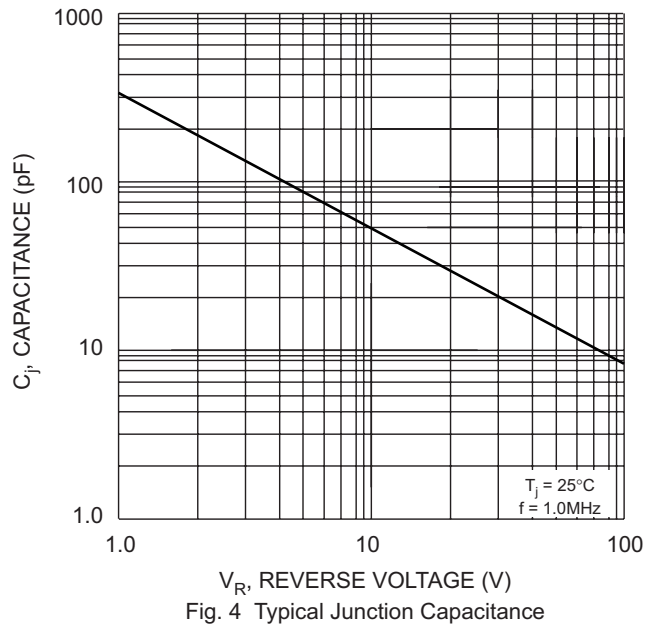
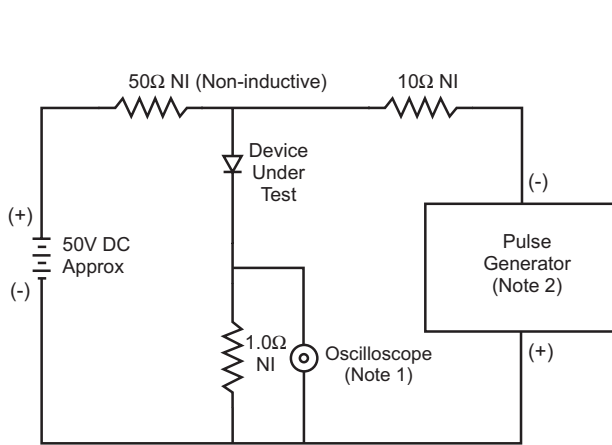

Fig. 4 Typical Junction Capacitance



- Notes:
1. Rise Time = 7.0ns max. Input Impedance = 1.0MΩ, 22pF.
 2. Rise Time = 10ns max. Input Impedance = 50Ω.

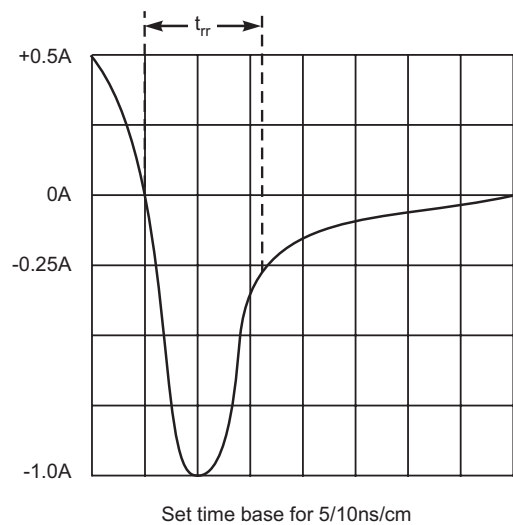

Fig. 5 Reverse Recovery Time Characteristic and Test Circuit

ORDERING INFORMATION

Product No.♦	Package Type	Shipping Quantity
SFR601-T3	R-6	800/Tape & Reel
SFR601	R-6	250 Units/Box
SFR602-T3	R-6	800/Tape & Reel
SFR602	R-6	250 Units/Box
SFR603-T3	R-6	800/Tape & Reel
SFR603	R-6	250 Units/Box
SFR604-T3	R-6	800/Tape & Reel
SFR604	R-6	250 Units/Box
SFR605-T3	R-6	800/Tape & Reel
SFR605	R-6	250 Units/Box
SFR606-T3	R-6	800/Tape & Reel
SFR606	R-6	250 Units/Box
SFR607-T3	R-6	800/Tape & Reel
SFR607	R-6	250 Units/Box

Products listed in **bold** are WTE **Preferred** devices.

♦T3 suffix refers to a 13" reel.

Shipping quantity given is for minimum packing quantity only. For minimum order quantity, please consult the Sales Department.

Won-Top Electronics Co., Ltd (WTE) has checked all information carefully and believes it to be correct and accurate. However, WTE cannot assume any responsibility for inaccuracies. Furthermore, this information does not give the purchaser of semiconductor devices any license under patent rights to manufacturer. WTE reserves the right to change any or all information herein without further notice.

WARNING: DO NOT USE IN LIFE SUPPORT EQUIPMENT. WTE power semiconductor products are not authorized for use as critical components in life support devices or systems without the express written approval.

Won-Top Electronics Co., Ltd.

No. 44 Yu Kang North 3rd Road, Chine Chen Dist., Kaohsiung, Taiwan

Phone: 886-7-822-5408 or 886-7-822-5410

Fax: 886-7-822-5417

Email: sales@wontop.com

Internet: http://www.wontop.com

We power your everyday.