





## Description

The ATF22V10B is a high performance CMOS (Electrically Erasable) Programmable Logic Device (PLD) which utilizes Atmel's proven electrically erasable Flash memory technology. Speeds down to 7.5 ns and power dissipation as low as 10 mA are offered. All speed ranges are specified over the full  $5V \pm 10\%$  range for military and industrial tempera-

ture ranges, and  $5V \pm 5\%$  for commercial temperature ranges.

Several low power options allow selection of the best solution for various types of power-limited applications. Each of these options significantly reduces total system power and enhances system reliability.

## Absolute Maximum Ratings\*

Temperature Under Bias .....	-55°C to +125°C
Storage Temperature .....	-65°C to +150°C
Voltage on Any Pin with Respect to Ground .....	-2.0V to +7.0V <sup>(1)</sup>
Voltage on Input Pins with Respect to Ground During Programming.....	-2.0V to +14.0V <sup>(1)</sup>
Programming Voltage with Respect to Ground .....	-2.0V to +14.0V <sup>(1)</sup>

\*NOTICE: Stresses beyond those listed under "Absolute Maximum Ratings" may cause permanent damage to the device. This is a stress rating only and functional operation of the device at these or any other conditions beyond those indicated in the operational sections of this specification is not implied. Exposure to absolute maximum rating conditions for extended periods may affect device reliability.

Note: 1. Minimum voltage is -0.6V DC, which may undershoot to -2.0V for pulses of less than 20 ns. Maximum output pin voltage is  $V_{CC} + 0.75V$  DC, which may overshoot to 7.0V for pulses of less than 20 ns.

## DC and AC Operating Conditions

	Commercial	Industrial	Military
Operating Temperature (Case)	0°C - 70°C	-40°C - 85°C	-55°C - 125°C
$V_{CC}$ Power Supply	$5V \pm 5\%$	$5V \pm 10\%$	$5V \pm 10\%$

## DC Characteristics

Symbol	Parameter	Condition	Min	Typ	Max	Units	
$I_{IL}$	Input or I/O Low Leakage Current	$0 \leq V_{IN} \leq V_{IL} (MAX)$		-35	-100	$\mu A$	
$I_{IH}$	Input or I/O High Leakage Current	$3.5 \leq V_{IN} \leq V_{CC}$			10	$\mu A$	
$I_{CC}$	Power Supply Current, Standby	$V_{CC} = MAX,$ $V_{IN} = MAX,$ Outputs Open	B-7, -10	Com.	85	120	mA
				Ind., Mil.	85	140	mA
			B-15, -25	Com.	65	90	mA
				Ind., Mil.	65	115	mA
			BQ-15	Com.	35	55	mA
			BQL-20, -25	Com.	5	10	mA
Ind., Mil.	5	15		mA			
$I_{CC2}$	Clocked Power Supply Current	$V_{CC} = MAX,$ Outputs Open, $f = 15 MHz$	B-7, -10	Com.	90	120	mA
				Ind., Mil.	90	145	mA
			B-15, -25	Com.	65	90	mA
				Ind., Mil.	65	120	mA
			BQ-15	Com.	40	60	mA
			BQL-20, -25	Com.	20	50	mA
Ind., Mil.	20	70		mA			
$I_{OS}^{(1)}$	Output Short Circuit Current	$V_{OUT} = 0.5V$			-130	mA	
$V_{IL}$	Input Low Voltage		-0.5		0.8	V	
$V_{IH}$	Input High Voltage		2.0		$V_{CC} + 0.75$	V	
$V_{OL}$	Output Low Voltage	$V_{IN} = V_{IH}$ or $V_{IL},$ $V_{CC} = MIN$	$I_{OL} = 16 mA$	Com., Ind.		0.5	V
			$I_{OL} = 12 mA$	Mil.		0.5	V
$V_{OH}$	Output High Voltage	$V_{IN} = V_{IH}$ or $V_{IL},$ $V_{CC} = MIN$	$I_{OH} = -4.0 mA$	2.4		V	

Notes: 1. Not more than one output at a time should be shorted. Duration of short circuit test should not exceed 30 sec.



## AC Waveforms<sup>(1)</sup>

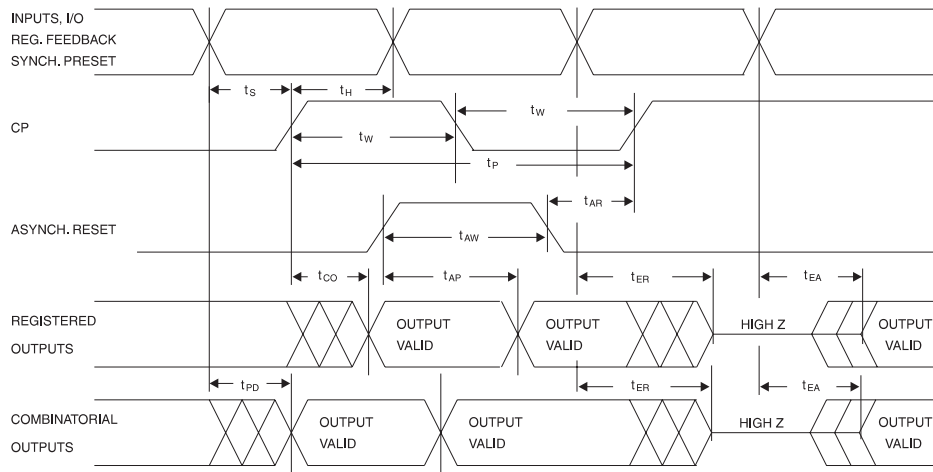

Note: 1. Timing measurement reference is 1.5V. Input AC driving levels are 0.0V and 3.0V, unless otherwise specified.

## AC Characteristics<sup>(1)</sup>

Symbol	Parameter	-7		-10		-15		-20		-25		Units
		Min	Max	Min	Max	Min	Max	Min	Max	Min	Max	
$t_{PD}$	Input or Feedback to Combinatorial Output	3	7.5	3	10	3	15	3	20	3	25	ns
$t_{CO}$	Clock to Output	2	4.5 <sup>(2)</sup>	2	6.5	2	8	2	12	2	15	ns
$t_{CF}$	Clock to Feedback		2.5		2.5		2.5		8		13	ns
$t_S$	Input or Feedback Setup Time	3.5		4.5		10			14	15		ns
$t_H$	Hold Time	0		0		0		0		0		ns
$F_{MAX}$	External Feedback $1/(t_S + t_{CO})$	125 <sup>(3)</sup>		90		55.5		38.5		33.3		MHz
	Internal Feedback $1/(t_S + t_{CF})$	166		142		69		45.5		40		MHz
	No Feedback $1/(t_{WH} + t_{WL})$	166		142		83.3				38.5		MHz
$t_W$	Clock Width ( $t_{WL}$ and $t_{WH}$ )	3		3.5		6		10		13		ns
$t_{EA}$	Input or I/O to Output Enable	3	7.5	3	10	3	15	3	20	3	25	ns
$t_{ER}$	Input or I/O to Output Disable	3	7.5	3	9	3	15	3	20	3	25	ns
$t_{AP}$	Input or I/O to Asynchronous Reset of Register	3	10	3	12	3	20	3	22	3	25	ns
$t_{AW}$	Asynchronous Reset Width	7		8		15		20		25		ns
$t_{AR}$	Asynchronous Reset Recovery Time	5		6		10		20		25		ns
$t_{SP}$	Setup Time, Synchronous Preset	4.5		6		10		14		15		ns
$t_{SPR}$	Synchronous Preset to Clock Recovery Time	5		8		10		14		15		ns

- Notes: 1. See ordering information for valid part numbers.  
 2. 5.5 ns for DIP package devices.  
 3. 111 MHz for DIP package devices.

## Input Test Waveforms and Measurement Levels

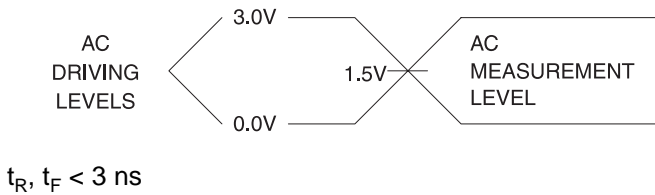

## Output Test Loads

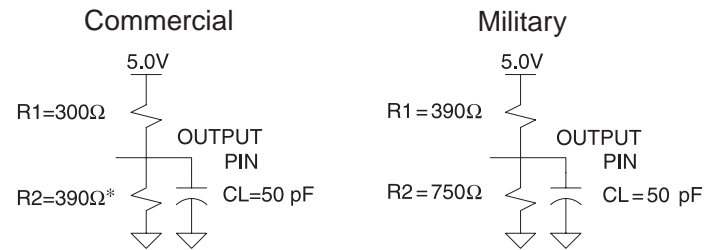

\* All except -7 which is  $R2 = 300\Omega$

## Pin Capacitance

$f = 1 \text{ MHz}, T = 25^\circ\text{C}^{(1)}$

	Typ	Max	Units	Conditions
$C_{IN}$	5	8	pF	$V_{IN} = 0V$
$C_{OUT}$	6	8	pF	$V_{OUT} = 0V$

Note: 1. Typical values for nominal supply voltage. This parameter is only sampled and is not 100% tested.

## Power Up Reset

The registers in the ATF22V10Bs are designed to reset during power up. At a point delayed slightly from  $V_{CC}$  crossing  $V_{RST}$ , all registers will be reset to the low state. The output state will depend on the polarity of the output buffer.

This feature is critical for state machine initialization. However, due to the asynchronous nature of reset and the uncertainty of how  $V_{CC}$  actually rises in the system, the following conditions are required:

1. The  $V_{CC}$  rise must be monotonic,
2. After reset occurs, all input and feedback setup times must be met before driving the clock pin high, and
3. The clock must remain stable during  $t_{PR}$ .

## Preload of Registered Outputs

The ATF22V10B's registers are provided with circuitry to allow loading of each register with either a high or a low. This feature will simplify testing since any state can be forced into the registers to control test sequencing. A JEDEC file with preload is generated when a source file with vectors is compiled. Once downloaded, the JEDEC file preload sequence will be done automatically by most of the approved programmers after the programming.

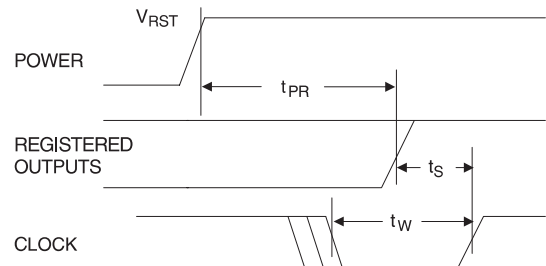

Parameter	Description	Typ	Max	Units
$t_{PR}$	Power-Up Reset Time	600	1,000	ns
$V_{RST}$	Power-Up Reset Voltage	3.8	4.5	V

## Security Fuse Usage

A single fuse is provided to prevent unauthorized copying of the ATF22V10B fuse patterns. Once programmed, fuse verify and preload are inhibited. However, the 64-bit User Signature remains accessible.

The security fuse should be programmed last, as its effect is immediate.

## Electronic Signature Word

There are 64 bits of programmable memory that are always available to the user, even if the device is secured. These bits can be used for user-specific data.

## Programming/Erasing

Programming/erasing is performed using standard PLD programmers. See *CMOS PLD Programming Hardware and Software Support* for information on software/programming.

## Input Diagram

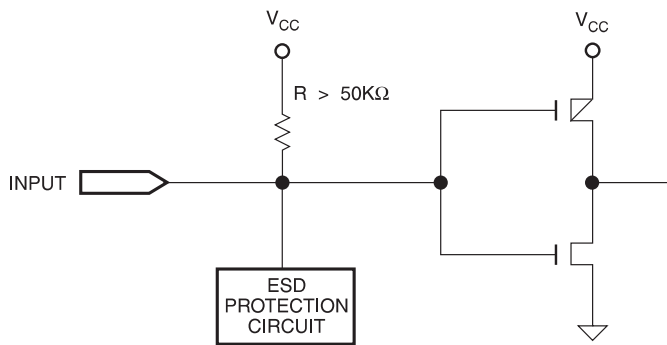

## Input and I/O Pull-Ups

All ATF22V10B family members have internal input and I/O pull-up resistors. Therefore, whenever inputs or I/Os are not being driven externally, they will float to V<sub>CC</sub>. This ensures that all logic array inputs are at known states. These are relatively weak active pull-ups that can easily be overdriven by TTL-compatible drivers (see input and I/O diagrams below).

## I/O Diagram

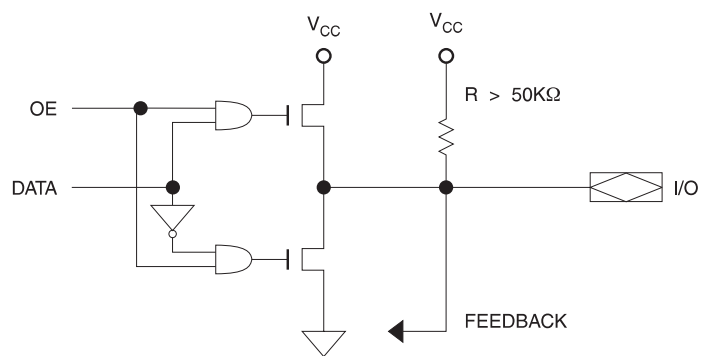

## Functional Logic Diagram ATF22V10B

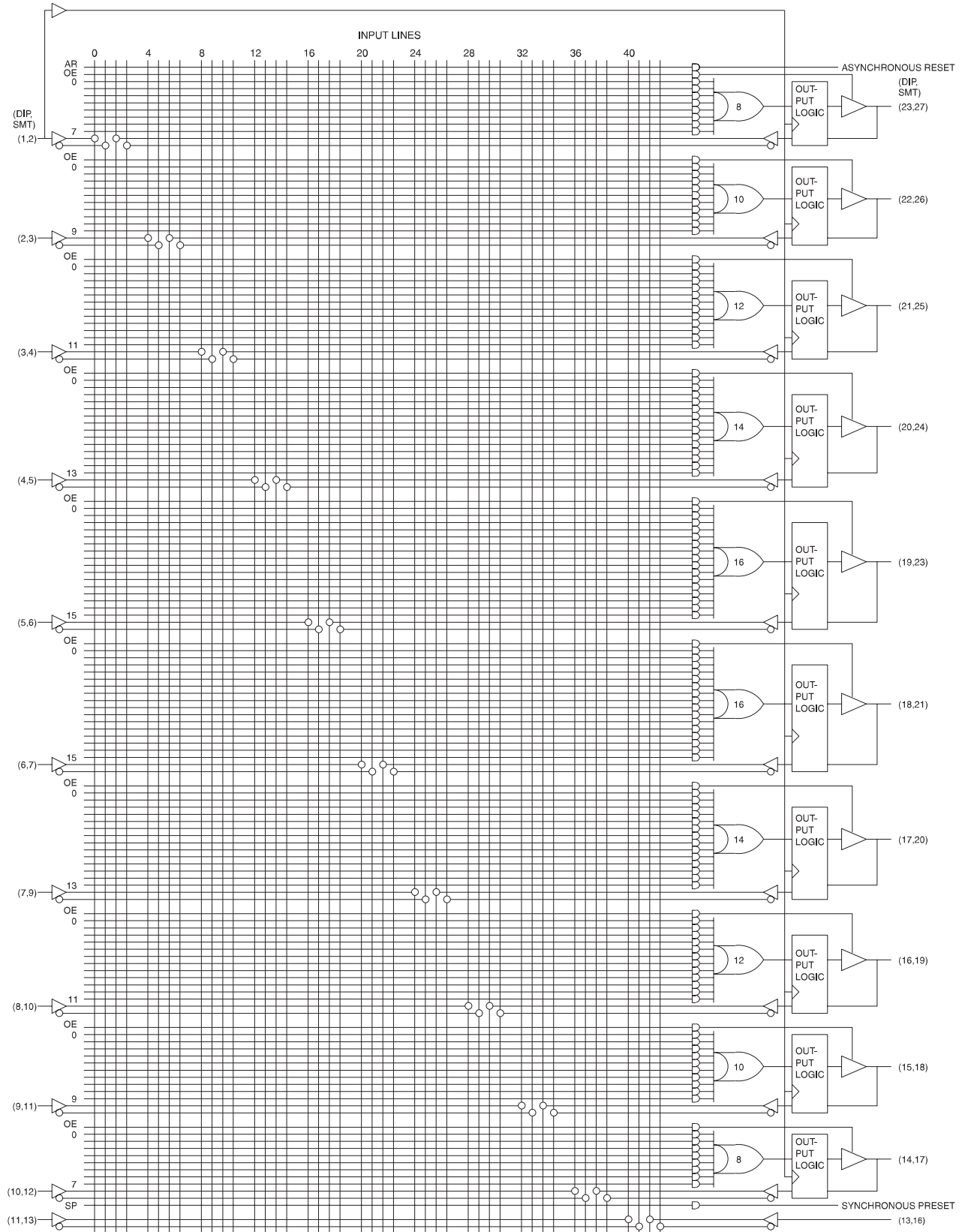

SUPPLY CURRENT vs. INPUT FREQUENCY  
ATF22V10B/BQ (VCC = 5V, TA = 25°C)

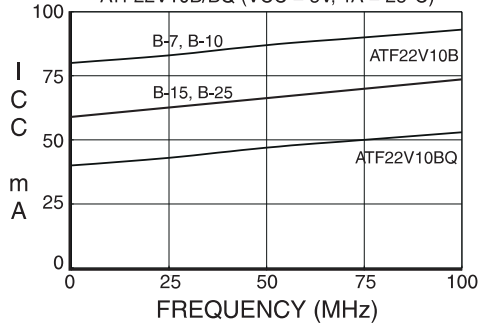

SUPPLY CURRENT vs. INPUT FREQUENCY  
ATF22V10BL/BQL (VCC = 5V, TA = 25°C)

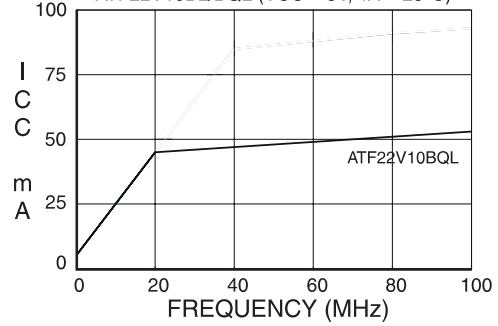

SUPPLY CURRENT vs. SUPPLY VOLTAGE  
ATF22V10B/BQ (TA = 25°C)

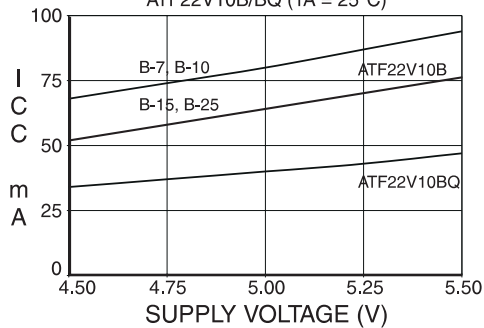

SUPPLY CURRENT vs. SUPPLY VOLTAGE  
ATF22V10BL/BQL (TA = 25°C)

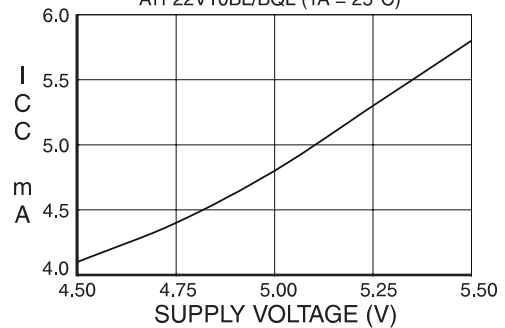

SUPPLY CURRENT vs. AMBIENT TEMPERATURE  
ATF22V10B/BQ (VCC = 5V)

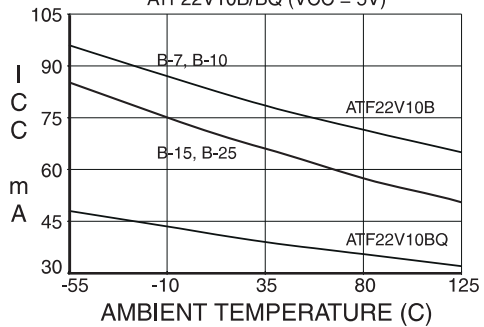

SUPPLY CURRENT vs. AMBIENT TEMPERATURE  
ATF22V10BL/BQL (VCC = 5V)

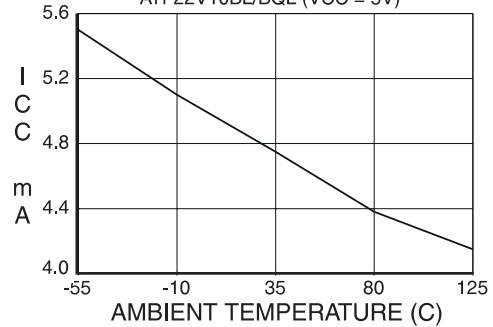

OUTPUT SOURCE CURRENT  
vs. SUPPLY VOLTAGE (VOH = 2.4V)

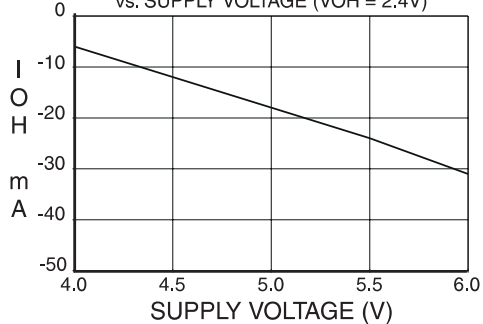

OUTPUT SINK CURRENT  
vs. SUPPLY VOLTAGE (VOL = 0.5V)

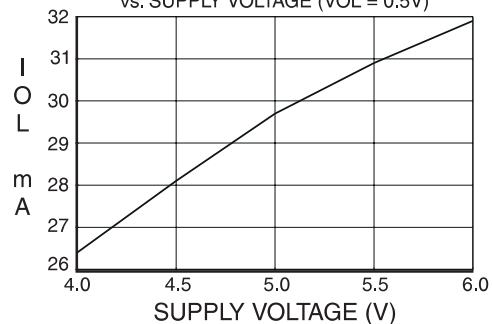



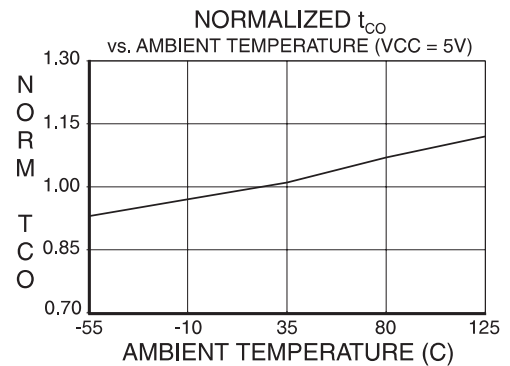
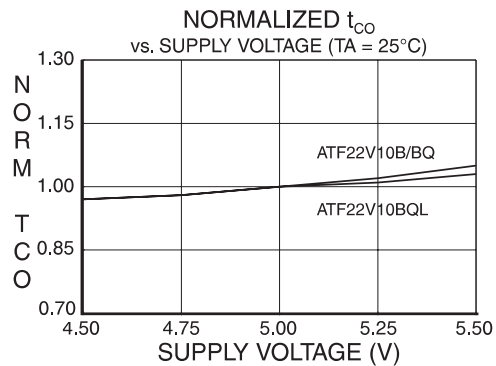
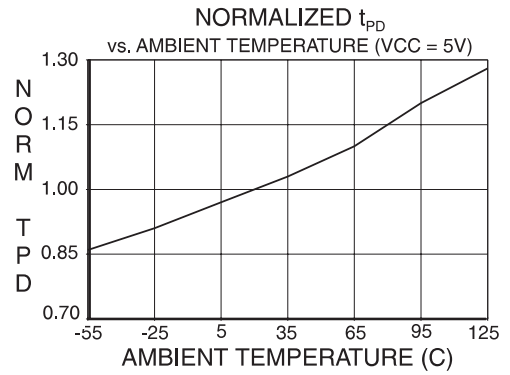
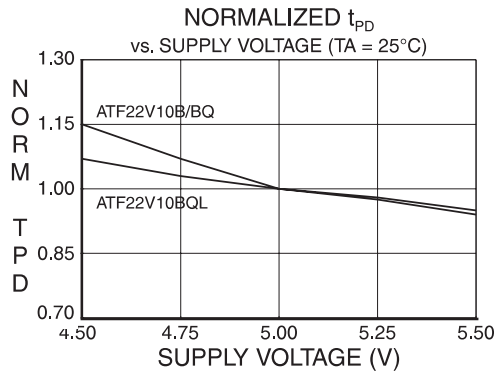
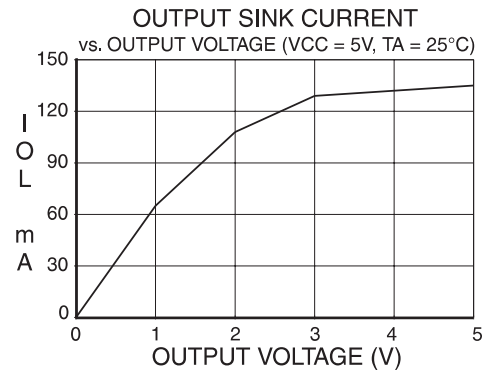
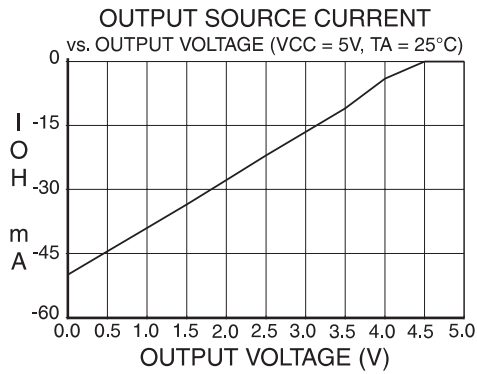
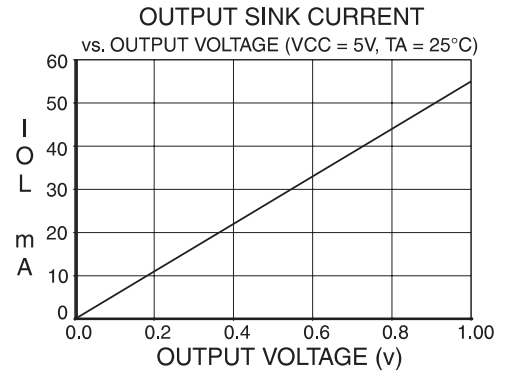
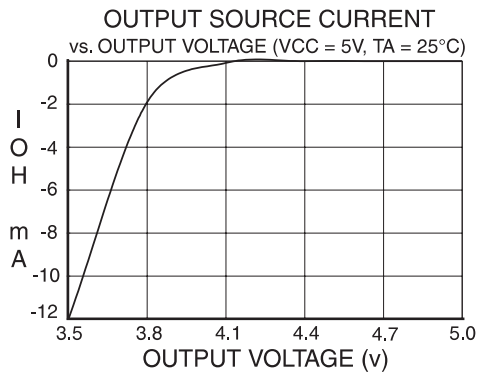

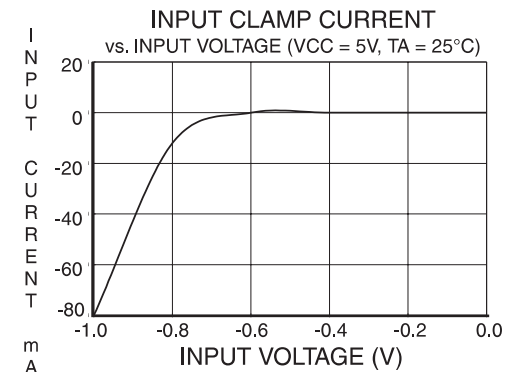
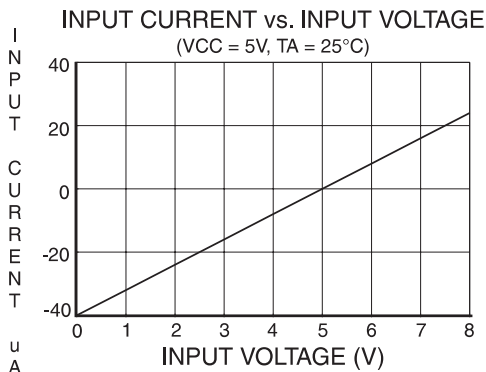
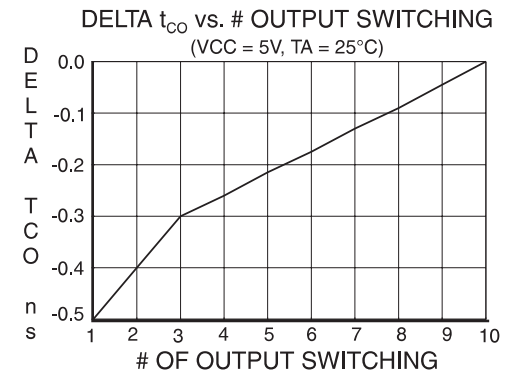
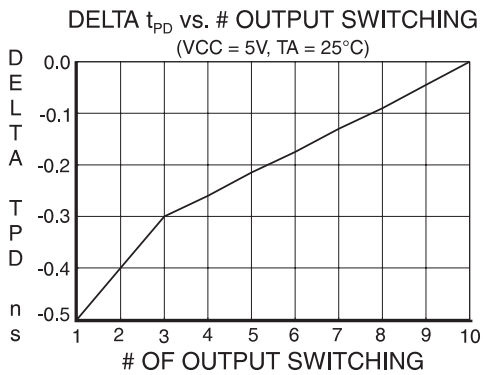
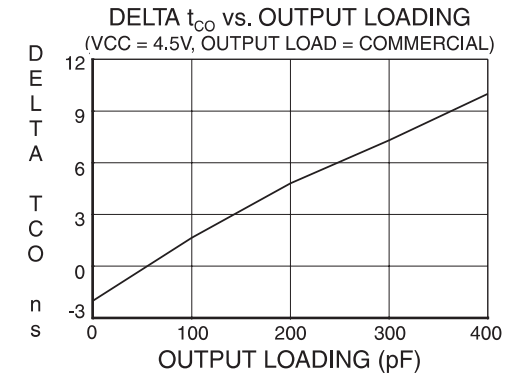
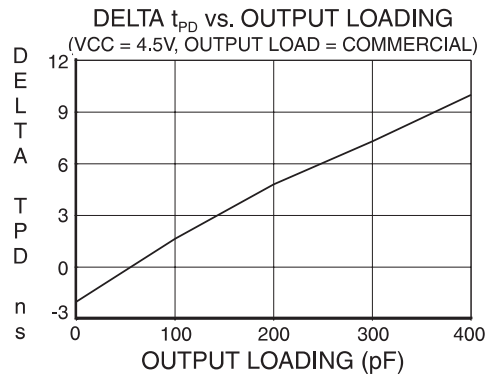
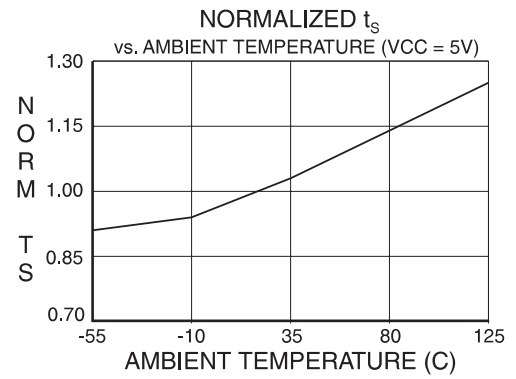
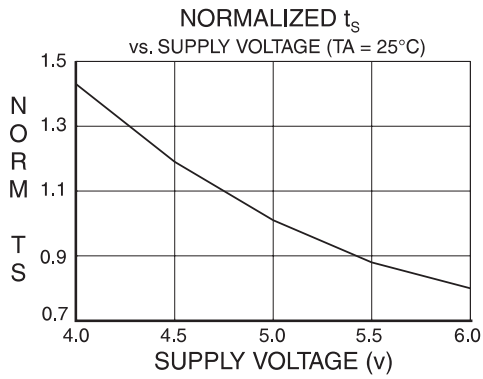

## Ordering Information

$t_{PD}$ (ns)	$t_S$ (ns)	$t_{CO}$ (ns)	Ordering Code	Package	Operation Range			
7.5	3.5	4.5	ATF22V10B-7JC <sup>(1)</sup>	28J	Commercial (0°C to 70°C)			
			ATF22V10B-7PC <sup>(1)</sup>	24P3				
			ATF22V10B-7SC <sup>(1)</sup>	24S				
			ATF22V10B-7XC <sup>(1)</sup>	24X				
10	4.5	6.5	ATF22V10B-10JC <sup>(1)</sup>	28J	Commercial (0°C to 70°C)			
			ATF22V10B-10PC <sup>(1)</sup>	24P3				
			ATF22V10B-10SC <sup>(1)</sup>	24S				
			ATF22V10B-10XC <sup>(1)</sup>	24X				
			ATF22V10B-10JI <sup>(1)</sup>	28J	Industrial (-40°C to 85°C)			
			ATF22V10B-10PI <sup>(1)</sup>	24P3				
			ATF22V10B-10SI <sup>(1)</sup>	24S				
			ATF22V10B-10XI <sup>(1)</sup>	24X				
			ATF22V10B-10GM/883	24D3	Military/883C (-55°C to 125°C) Class B, Fully Compliant			
			ATF22V10B-10NM/883	28L				
			15	10	8	ATF22V10B-15JC	28J	Commercial (0°C to 70°C)
						ATF22V10B-15PC	24P3	
ATF22V10B-15SC	24S							
ATF22V10B-15XC	24X							
ATF22V10B-15JI	28J	Industrial (-40°C to 85°C)						
ATF22V10B-15PI	24P3							
ATF22V10B-15SI	24S							
ATF22V10B-15XI	24X							
ATF22V10B-15GM/883	24D3	Military/883C (-55°C to 125°C) Class B, Fully Compliant						
ATF22V10B-15NM/883	28L							
25	15	15				ATF22V10B-25JC	28J	Commercial (0°C to 70°C)
						ATF22V10B-25PC	24P3	
			ATF22V10B-25SC	24S				
			ATF22V10B-25XC	24X				
			ATF22V10B-25JI	28J	Industrial (-40°C to 85°C)			
			ATF22V10B-25PI	24P3				
			ATF22V10B-25SI	24S				
			ATF22V10B-25XI	24X				
10	4.5	6.5	5962-89841 06LA	24D3	Military (-55°C to 125°C) Class B, Fully Compliant			
			5962-89841 063X	28L				
15	10	8	5962-89841 03LA <sup>(2)</sup>	24D3	Military (-55°C to 125°C) Class B, Fully Compliant			
			5962-89841 033X <sup>(2)</sup>	28L				
			5962-89841 05LA	24D3				
			5962-89841 053X	28L				

Notes: 1. Recommend ATF22V10C versions.

2. Difference between 03 and 05 is that 05 has a relaxed  $t_{CO} = 12$  ns and  $f_{MAX}$  (with external feedback) = 42 MHz.



## Ordering Information

$t_{PD}$ (ns)	$t_S$ (ns)	$t_{CO}$ (ns)	Ordering Code	Package	Operation Range
15	10	8	ATF22V10BQ-15JC	28J	Commercial (0°C to 70°C)
			ATF22V10BQ-15PC	24P3	
			ATF22V10BQ-15SC	24S	
			ATF22V10BQ-15XC	24X	
20	14	12	ATF22V10BQL-20JC	28J	Commercial (0°C to 70°C)
			ATF22V10BQL-20PC	24P3	
			ATF22V10BQL-20SC	24S	
			ATF22V10BQL-20XC	24X	
		ATF22V10BQL-20JI	28J	Industrial (-40°C to 85°C)	
		ATF22V10BQL-20PI	24P3		
		ATF22V10BQL-20SI	24S		
		ATF22V10BQL-20XI	24X		
		ATF22V10BQL-20GM/883	24D3	Military/883C (-55°C to 125°C) Class B, Fully Compliant	
ATF22V10BQL-20GM/883	28L				
25	15	15	ATF22V10BQL-25JC	28J	Commercial (0°C to 70°C)
			ATF22V10BQL-25PC	24P3	
			ATF22V10BQL-25SC	24S	
			ATF22V10BQL-25XC	24X	
		ATF22V10BQL-25JI	28J	Industrial (-40°C to 85°C)	
		ATF22V10BQL-25PI	24P3		
		ATF22V10BQL-25SI	24S		
		ATF22V10BQL-25XI	24X		
		ATF22V10BQL-25GM/883	24D3	Military/883C (-55°C to 125°C) Class B, Fully Compliant	
ATF22V10BQL-25NM/883	28L				
20	14	12	5962-89841 14 LA	24D3	Class B, Fully Compliant
			5962-89841 14 3X	28L	
25	15	15	5962-89841 13 LA	24D3	
			5962-89841 13 3X	28L	

Package Type	
<b>24D3</b>	24-Lead, 0.300" Wide, Ceramic Dual Inline Package (Cerdip)
<b>28J</b>	28-Lead, Plastic J-Leaded Chip Carrier (PLCC)
<b>28L</b>	28-Pad, Ceramic Leadless Chip Carrier (LCC)
<b>24P3</b>	24-Lead, 0.300" Wide, Plastic Dual Inline Package (PDIP)
<b>24S</b>	24-Lead, 0.300" Wide, Plastic Gull Wing Small Outline (SOIC)
<b>24X</b>	24-Lead, 4.4 mm Wide, Plastic Thin Shrink Small Outline (TSSOP)



## Packaging Information

**24S**, 24-Lead, 0.300" Wide, Plastic Gull Wing Small Outline (SOIC)  
 Dimensions in Inches and (Millimeters)

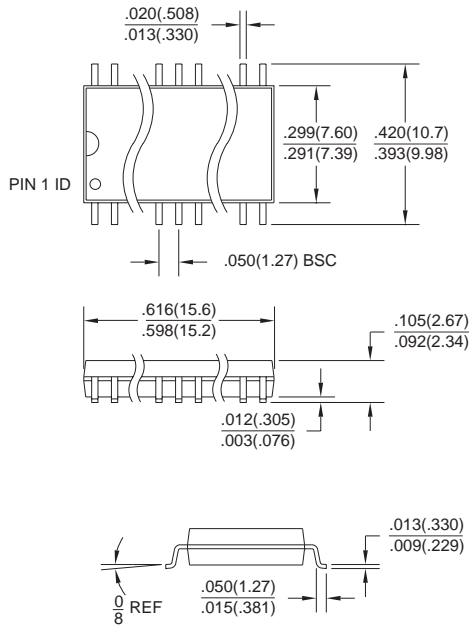

**24X**, 24-Lead, 4.4 mm Wide, Plastic Thin Shrink Small Outline (TSSOP)  
 Dimensions in Millimeters and (Inches)

