

Designer's™ Data Sheet
NPN Silicon Power Transistors
1.5 kV SWITCHMODE Series

These transistors are designed for high-voltage, high-speed, power switching in inductive circuits where fall time is critical. They are particularly suited for line-operated switchmode applications.

Typical Applications:

Features:

- Switching Regulators
- Inverters
- Solenoids
- Relay Drivers
- Motor Controls
- Deflection Circuits
- Collector-Emitter Voltage — $V_{CEV} = 1500$ Vdc
- Fast Turn-Off Times
 - 80 ns Inductive Fall Time — 100°C (Typ)
 - 110 ns Inductive Crossover Time — 100°C (Typ)
 - 4.5 μ s Inductive Storage Time — 100°C (Typ)
- 100°C Performance Specified for:
 - Reverse-Biased SOA with Inductive Load
 - Switching Times with Inductive Loads
 - Saturation Voltages
 - Leakage Currents

MJ16018*
MJW16018*

*Motorola Preferred Device

POWER TRANSISTORS
10 AMPERES
800 VOLTS
125 AND 175 WATTS

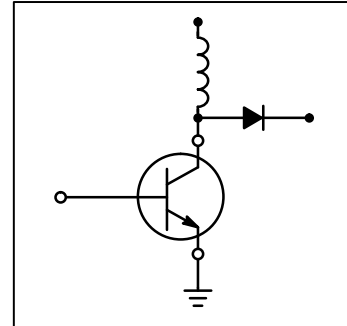

MAXIMUM RATINGS

Rating	Symbol	MJ16018	MJW16018	Unit
Collector-Emitter Voltage	$V_{CEO(sus)}$	800		Vdc
Collector-Emitter Voltage	V_{CEV}	1500		Vdc
Emitter-Base Voltage	V_{EB}	6		Vdc
Collector Current — Continuous	I_C	10		Adc
— Peak(1)	I_{CM}	15		
Base Current — Continuous	I_B	8		Adc
— Peak(1)	I_{BM}	12		
Total Power Dissipation	P_D			
@ $T_C = 25^\circ\text{C}$		175	125	Watts
@ $T_C = 100^\circ\text{C}$		100	50	
Derate above $T_C = 25^\circ\text{C}$		1	1	W/°C
Operating and Storage Junction Temperature Range	T_J, T_{stg}	-65 to 200	-55 to 150	°C

THERMAL CHARACTERISTICS

Characteristic	Symbol	Max		Unit
Thermal Resistance, Junction to Case	$R_{\theta JC}$	1	1	°C/W
Lead Temperature for Soldering Purposes: 1/8" from Case for 5 Seconds	T_L	275		°C

(1) Pulse Test: Pulse Width = 5 μ s, Duty Cycle \leq 10%.

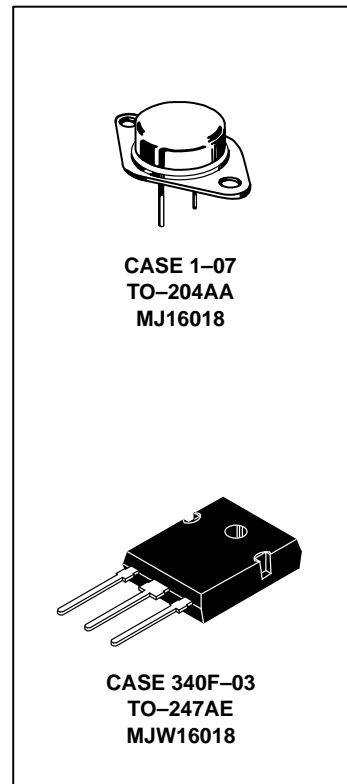

Designer's Data for "Worst Case" Conditions — The Designer's Data Sheet permits the design of most circuits entirely from the information presented. SOA Limit curves — representing boundaries on device characteristics — are given to facilitate "worst case" design.

Preferred devices are Motorola recommended choices for future use and best overall value.

Designer's and SWITCHMODE are trademarks of Motorola, Inc.

REV 1

MJ16018 MJW16018

ELECTRICAL CHARACTERISTICS (T_C = 25°C unless otherwise noted)

Characteristic	Symbol	Min	Typ	Max	Unit
Collector–Emitter Sustaining Voltage (Table 1) (I _C = 50 mA, I _B = 0)	V _{CEO(sus)}	800	—	—	Vdc
Collector Cutoff Current (V _{CEV} = 1500 Vdc, V _{BE(off)} = 1.5 Vdc) (V _{CEV} = 1500 Vdc, V _{BE(off)} = 1.5 Vdc, T _C = 100°C)	I _{CEV}	—	—	0.25 1.5	mAdc
Collector Cutoff Current (V _{CE} = 1500 Vdc, R _{BE} = 50 Ω, T _C = 100°C)	I _{CER}	—	—	2.5	mAdc
Emitter Cutoff Current (V _{EB} = 6 Vdc, I _C = 0)	I _{EBO}	—	—	0.1	mAdc

SECOND BREAKDOWN

Second Breakdown Collector Current with Base Forward Biased	I _{S/b}	See Figure 13			
Clamped Inductive SOA with Base Reverse Biased	RBSOA	See Figure 14			

ON CHARACTERISTICS(1)

Collector–Emitter Saturation Voltage (I _C = 5 Adc, I _B = 2 Adc) (I _C = 10 Adc, I _B = 5 Adc) (I _C = 5 Adc, I _B = 2 Adc, T _C = 100°C)	V _{CE(sat)}	— — —	— — —	1 5 1.5	Vdc
Base–Emitter Saturation Voltage (I _C = 5 Adc, I _B = 2 Adc) (I _C = 5 Adc, I _B = 2 Adc, T _C = 100°C)	V _{BE(sat)}	— —	— —	1.5 1.5	Vdc
DC Current Gain (I _C = 5 Adc, V _{CE} = 5 Vdc)	h _{FE}	4	—	—	—

DYNAMIC CHARACTERISTICS

Output Capacitance (V _{CB} = 10 Vdc, I _E = 0, f _{test} = 1 kHz)	C _{ob}	—	—	450	pF
--	-----------------	---	---	-----	----

SWITCHING CHARACTERISTICS

Inductive Load (Table 1)							
Storage Time	Baker Clamped (I _C = 5 Adc, I _{B1} = 2 Adc, V _{BE(off)} = 2 Vdc, V _{CE(pk)} = 400 Vdc) PW = 25 μs	(T _J = 25°C)	t _{sv}	—	4000	8000	ns
Fall Time			t _{fi}	—	60	200	
Crossover Time			t _c	—	90	300	
Storage Time			t _{sv}	—	4500	9000	
Fall Time			t _{fi}	—	80	250	
Crossover Time			t _c	—	110	375	
Resistive Load (Table 1)							
Delay Time	Baker Clamped (I _C = 5 Adc, V _{CC} = 250 Vdc, I _{B1} = 2 Adc, I _{B2} = 2 Adc, R _{B2} = 3 Ω, PW = 25 μs, Duty Cycle ≤ 2%)	(T _J = 25°C)	t _d	—	85	200	ns
Rise Time			t _r	—	900	2000	
Storage Time			t _s	—	4500	9000	
Fall Time			t _f	—	200	400	

(1) Pulse Test: PW = 300 μs, Duty Cycle ≤ 2%.

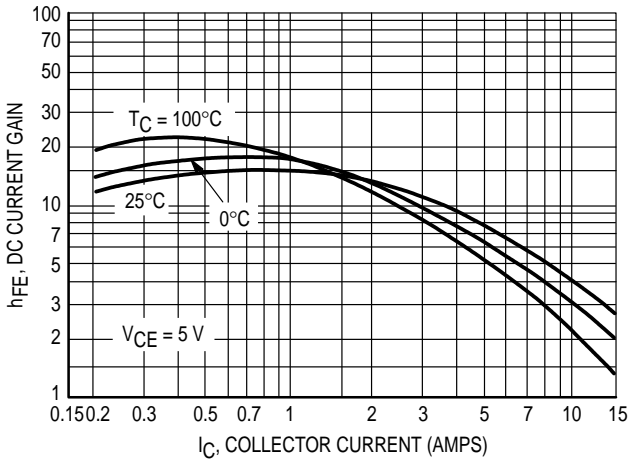

Figure 1. DC Current Gain

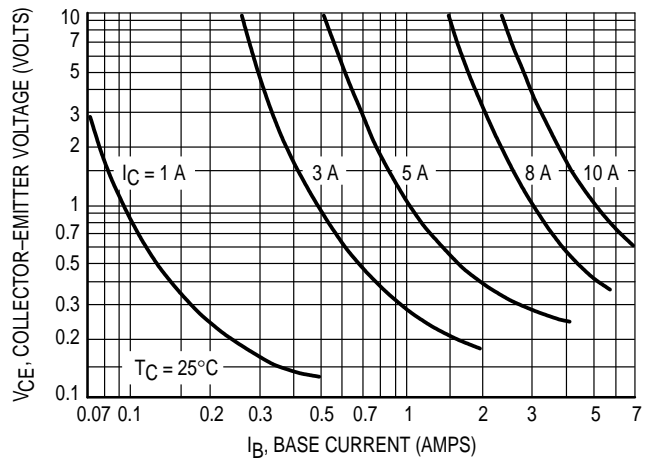

Figure 2. Collector Saturation Region

TYPICAL STATIC CHARACTERISTICS

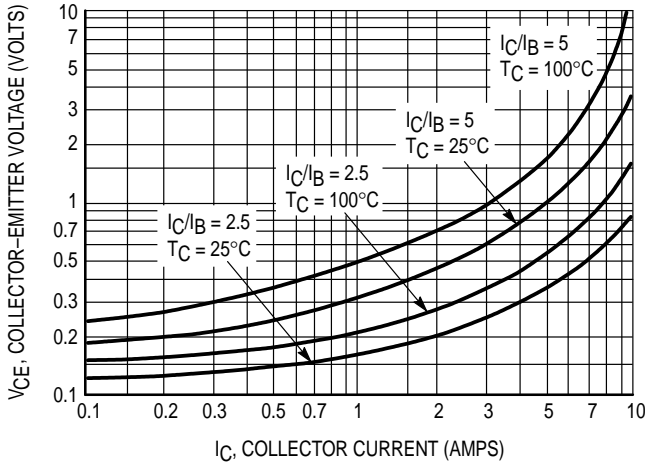

Figure 3. Collector-Emitter Saturation Region

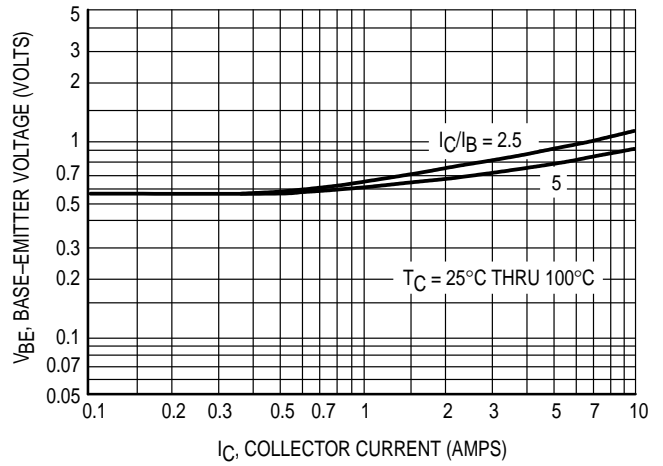

Figure 4. Base-Emitter Saturation Region

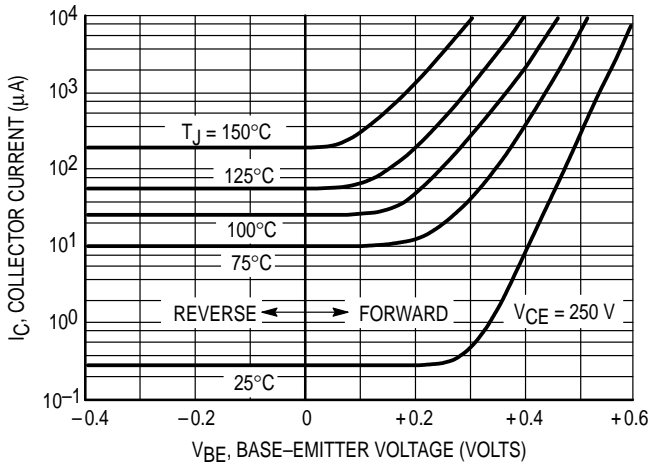

Figure 5. Collector Cutoff Region

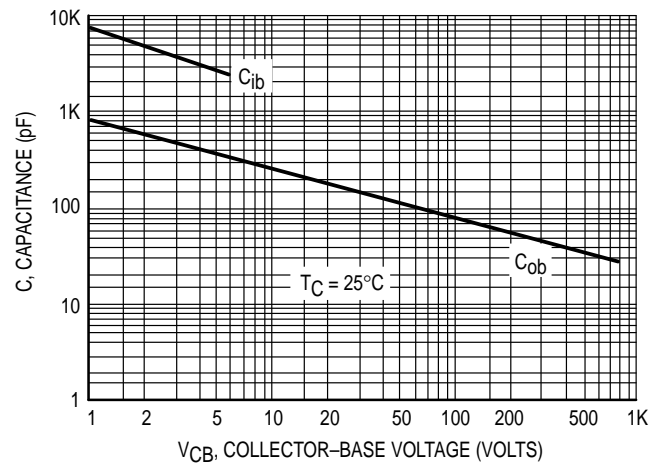

Figure 6. Typical Capacitance

TYPICAL INDUCTIVE SWITCHING CHARACTERISTICS

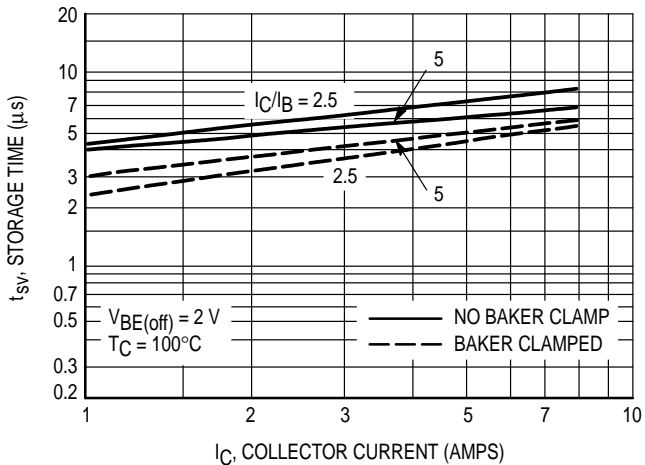

Figure 7. Storage Time

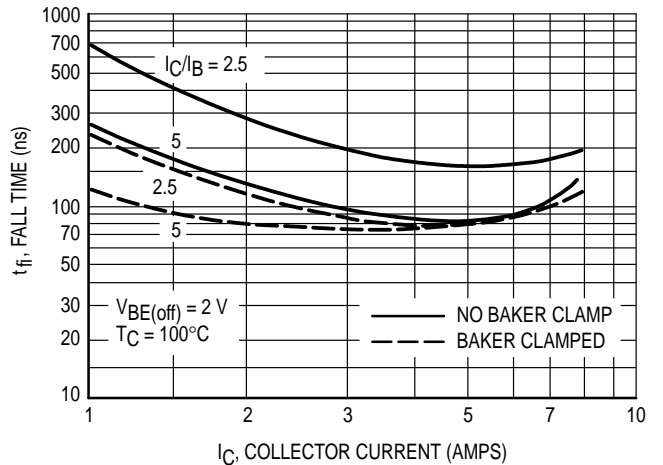

Figure 8. Inductive Switching Fall Time

TYPICAL INDUCTIVE SWITCHING CHARACTERISTICS

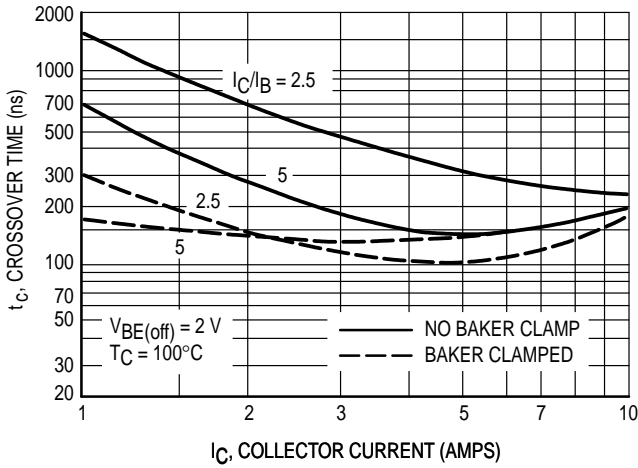

Figure 9. Inductive Switching Crossover Time

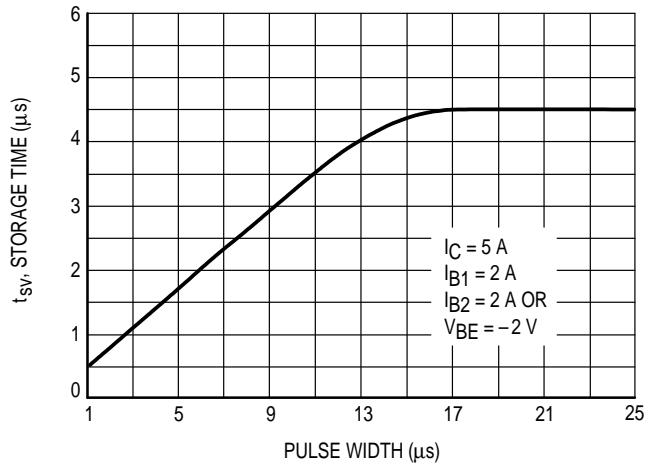

Figure 10. (t_{sv}) Storage Time versus I_{B1} Pulse Width

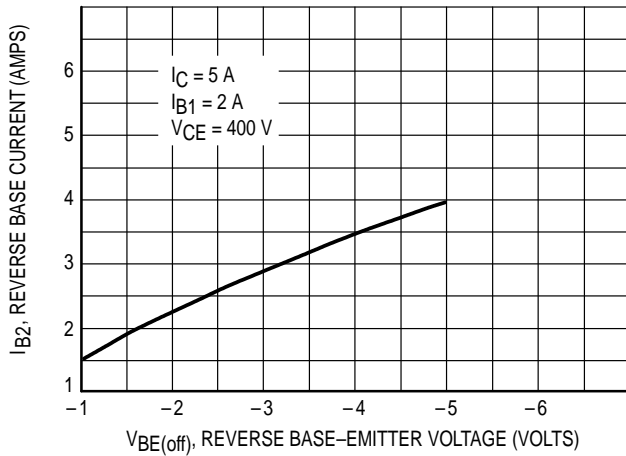

Figure 11. Reverse Base Current versus Off Voltage

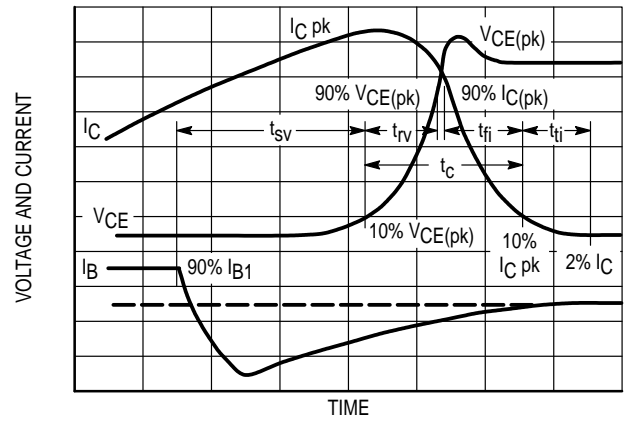

Figure 12. Inductive Switching Measurements

GUARANTEED SAFE OPERATING AREA LIMITS

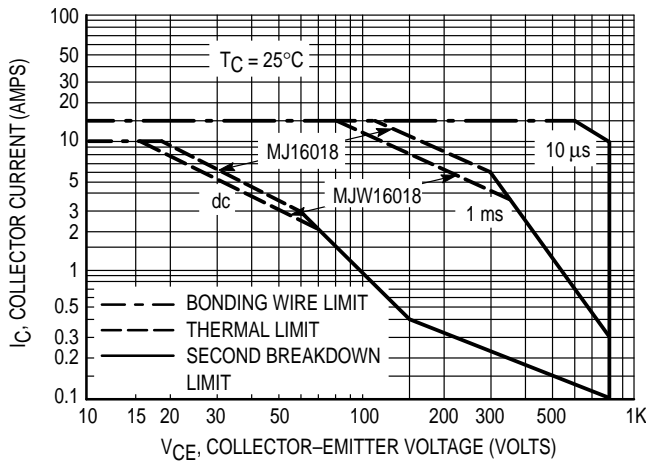

Figure 13. Maximum Forward Bias Safe Operating Area

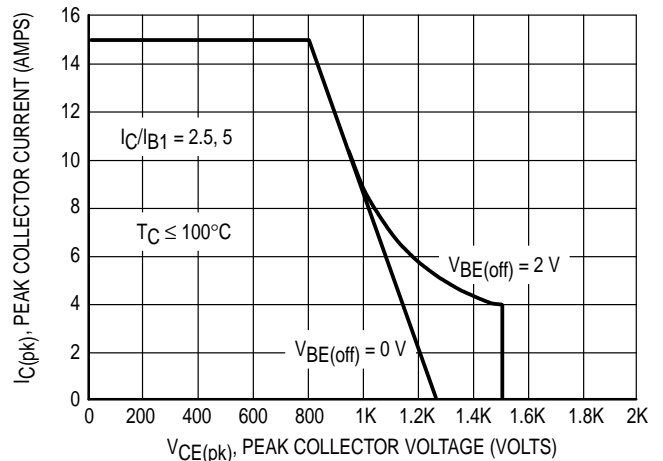

Figure 14. Maximum Reverse Bias Safe Operating Area

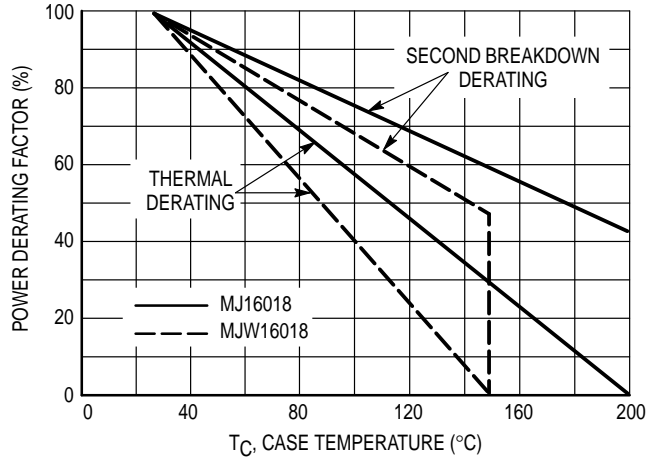

Figure 15. Power Derating

SAFE OPERATING AREA INFORMATION

FORWARD BIAS

There are two limitations on the power handling ability of a transistor: average junction temperature and second breakdown. Safe operating area curves indicate $I_C - V_{CE}$ limits of the transistor that must be observed for reliable operation; i.e., the transistor must not be subjected to greater dissipation than the curves indicate.

The data of Figure 13 is based on $T_C = 25^\circ\text{C}$; $T_J(\text{pk})$ is variable depending on power level. Second breakdown pulse limits are valid for duty cycles to 10% but must be derated when $T_C \geq 25^\circ\text{C}$. Second breakdown limitations do not derate the same as thermal limitations. Allowable current at the voltages shown on Figure 13 may be found at any case temperature by using the appropriate curve on Figure 15.

$T_J(\text{pk})$ may be calculated from the data in Figure 16. At high case temperatures, thermal limitations will reduce the

power that can be handled to values less than the limitations imposed by second breakdown.

REVERSE BIAS

For inductive loads, high voltage and high current must be sustained simultaneously during turn-off, in most cases, with the base-to-emitter junction reverse biased. Under these conditions the collector voltage must be held to a safe level at or below a specific value of collector current. This can be accomplished by several means such as active clamping, RC snubbing, load line shaping, etc. The safe level for these devices is specified as Reverse Bias Safe Operating Area and represents the voltage current condition allowable during reverse biased turnoff. This rating is verified under clamped conditions so that the device is never subjected to an avalanche mode. Figure 14 gives the RBSOA characteristics.

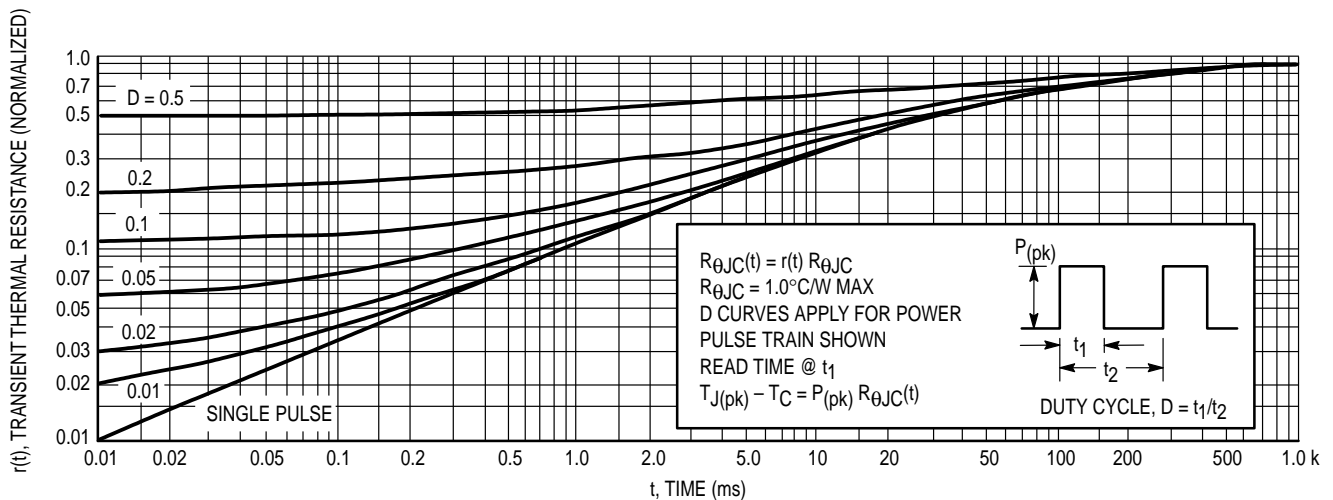
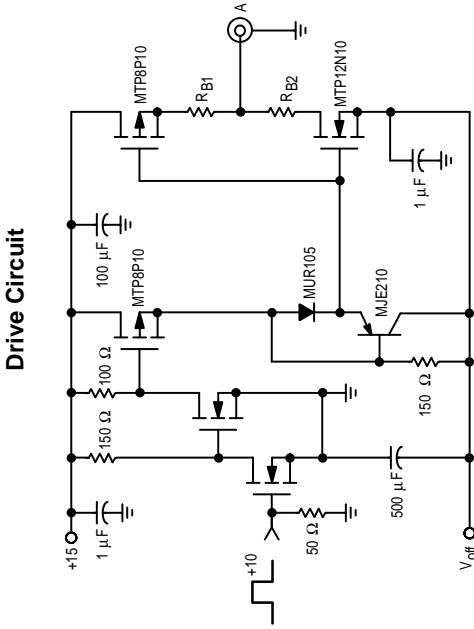
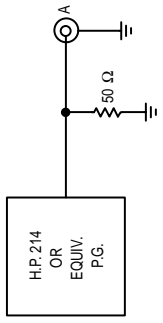
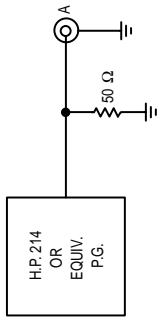
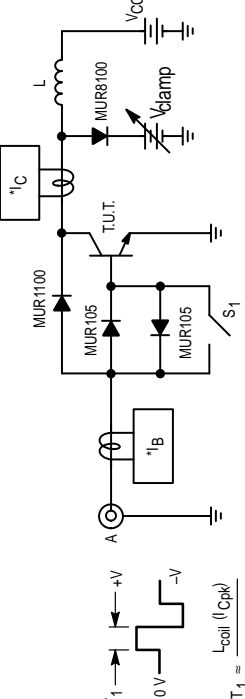
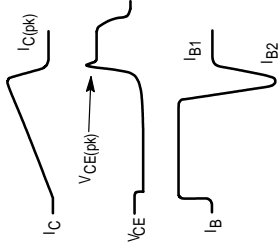
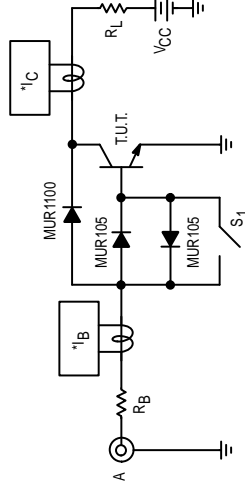
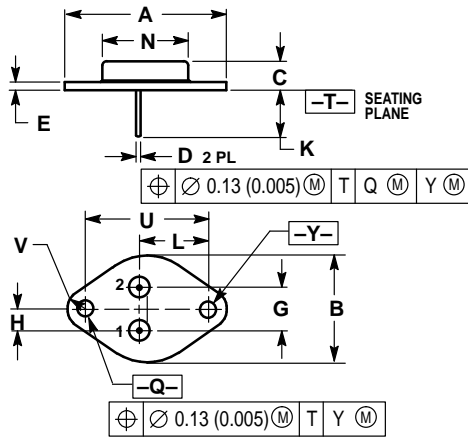

Figure 16. Thermal Response

Table 1. Test Conditions for Dynamic Performance

V _{CEO} (sus)	RBSOA	Inductive Switching	Resistive Switching
<p>Input Conditions</p>	<p>Drive Circuit</p>  <p>Note: Adjust V_{off} to obtain desired V_{BE(off)} at Point A</p>	<p>Inductive Switching</p>  <p>For t_d and t_r:</p> <p>V_{in} ≈ 11 V</p> <p>t_r ≤ 15 ns</p> <p>For t_s and t_f: Inductive Switching Drive Circuit</p>	<p>Resistive Switching</p>  <p>For t_d and t_r: Inductive Switching Drive Circuit</p>
<p>Circuit Values</p> <p>L = 10 mH R_{B2} = ∞ V_{CC} = 20 Volts I_{C(pk)} = 50 mA S₁ Closed</p>	<p>L = 200 µH R_{B2} = 0 V_{CC} = 20 Volts R_{B1} selected for desired I_{B1} S₁ Closed</p>	<p>L = 200 µH R_{B2} = 0 when V_{BE}(off) is specified or selected for desired I_{B2} V_{CC} ≈ 20 Volts, Adjusted to obtain desired I_C R_{B1} selected for desired I_{B1} S₁ = Open for baker clamp condition</p>	<p>for t_d and t_r V_{CC} = 250 Volts R_B selected for desired I_{B1} R_L selected for desired I_C</p> <p>for t_s and t_f V_{CC} = 250 Volts R_B = 0 R_{B1} & R_{B2} selected for I_{B1} & I_{B2} R_L selected for desired I_C</p>
<p>Test Circuit</p>  <p>T₁ adjusted to obtain I_{C(pk)}</p> <p>T₁ = $\frac{L_{coil} I_{C(pk)}}{V_{CC}}$</p>	<p>L = 200 µH R_{B2} = 0 V_{CC} = 20 Volts R_{B1} selected for desired I_{B1} S₁ Closed</p>		 <p>*Tektronix AM503 P6302 or Equivalent</p>

PACKAGE DIMENSIONS



- NOTES:
 1. DIMENSIONING AND TOLERANCING PER ANSI Y14.5M, 1982.
 2. CONTROLLING DIMENSION: INCH.
 3. ALL RULES AND NOTES ASSOCIATED WITH REFERENCED TO-204AA OUTLINE SHALL APPLY.

DIM	INCHES		MILLIMETERS	
	MIN	MAX	MIN	MAX
A	1.550 REF	—	39.37 REF	—
B	—	1.050	—	26.67
C	0.250	0.335	6.35	8.51
D	0.038	0.043	0.97	1.09
E	0.055	0.070	1.40	1.77
G	0.430 BSC	—	10.92 BSC	—
H	0.215 BSC	—	5.46 BSC	—
K	0.440	0.480	11.18	12.19
L	0.665 BSC	—	16.89 BSC	—
N	—	0.830	—	21.08
Q	0.151	0.165	3.84	4.19
U	1.187 BSC	—	30.15 BSC	—
V	0.131	0.188	3.33	4.77

STYLE 1:
 PIN 1. BASE
 2. EMITTER
 CASE: COLLECTOR

CASE 1-07
 TO-204AA (TO-3)
 ISSUE Z

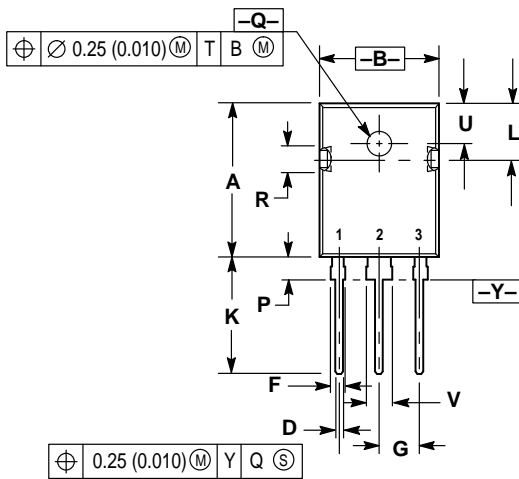

- NOTES:
 1. DIMENSIONING AND TOLERANCING PER ANSI Y14.5M, 1982.
 2. CONTROLLING DIMENSION: MILLIMETER.

DIM	MILLIMETERS		INCHES	
	MIN	MAX	MIN	MAX
A	20.40	20.90	0.803	0.823
B	15.44	15.95	0.608	0.628
C	4.70	5.21	0.185	0.205
D	1.09	1.30	0.043	0.051
E	1.50	1.63	0.059	0.064
F	1.80	2.18	0.071	0.086
G	5.45 BSC	—	0.215 BSC	—
H	2.56	2.87	0.101	0.113
J	0.48	0.68	0.019	0.027
K	15.57	16.08	0.613	0.633
L	7.26	7.50	0.286	0.295
P	3.10	3.38	0.122	0.133
Q	3.50	3.70	0.138	0.145
R	3.30	3.80	0.130	0.150
U	5.30 BSC	—	0.209 BSC	—
V	3.05	3.40	0.120	0.134

STYLE 3:
 PIN 1. BASE
 2. COLLECTOR
 3. EMITTER
 4. COLLECTOR

CASE 340F-03
 TO-247AE
 ISSUE E

Motorola reserves the right to make changes without further notice to any products herein. Motorola makes no warranty, representation or guarantee regarding the suitability of its products for any particular purpose, nor does Motorola assume any liability arising out of the application or use of any product or circuit, and specifically disclaims any and all liability, including without limitation consequential or incidental damages. "Typical" parameters can and do vary in different applications. All operating parameters, including "Typicals" must be validated for each customer application by customer's technical experts. Motorola does not convey any license under its patent rights nor the rights of others. Motorola products are not designed, intended, or authorized for use as components in systems intended for surgical implant into the body, or other applications intended to support or sustain life, or for any other application in which the failure of the Motorola product could create a situation where personal injury or death may occur. Should Buyer purchase or use Motorola products for any such unintended or unauthorized application, Buyer shall indemnify and hold Motorola and its officers, employees, subsidiaries, affiliates, and distributors harmless against all claims, costs, damages, and expenses, and reasonable attorney fees arising out of, directly or indirectly, any claim of personal injury or death associated with such unintended or unauthorized use, even if such claim alleges that Motorola was negligent regarding the design or manufacture of the part. Motorola and  are registered trademarks of Motorola, Inc. Motorola, Inc. is an Equal Opportunity/Affirmative Action Employer.

How to reach us:

USA / EUROPE: Motorola Literature Distribution;
P.O. Box 20912; Phoenix, Arizona 85036. 1-800-441-2447

JAPAN: Nippon Motorola Ltd.; Tatsumi-SPD-JLDC, Toshikatsu Otsuki,
6F Seibu-Butsuryu-Center, 3-14-2 Tatsumi Koto-Ku, Tokyo 135, Japan. 03-3521-8315

MFAX: RMFAX0@email.sps.mot.com - TOUCHTONE (602) 244-6609
INTERNET: <http://Design-NET.com>

HONG KONG: Motorola Semiconductors H.K. Ltd.; 8B Tai Ping Industrial Park,
51 Ting Kok Road, Tai Po, N.T., Hong Kong. 852-26629298

